

Blue Nile 70, Art.No.703041  
 Groundplan - Grundplan - Plan de masse - Planimetria - Plattegrond - Põhiplaan

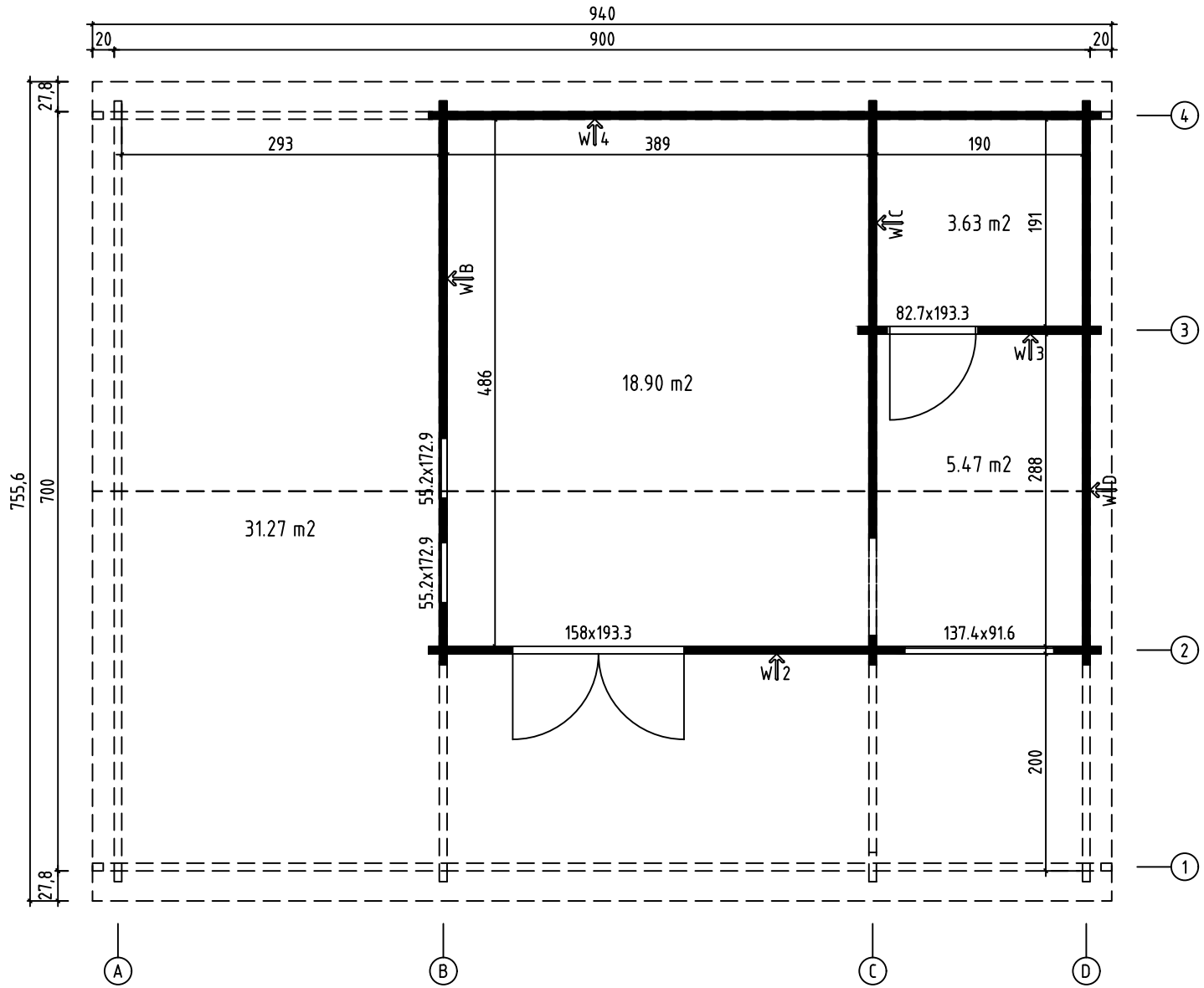

Blue Nile 70, Art.No.703041  
Foundation - Fundament - Fondation - Fundamenta - Fundering - Immutatud  
alusraam

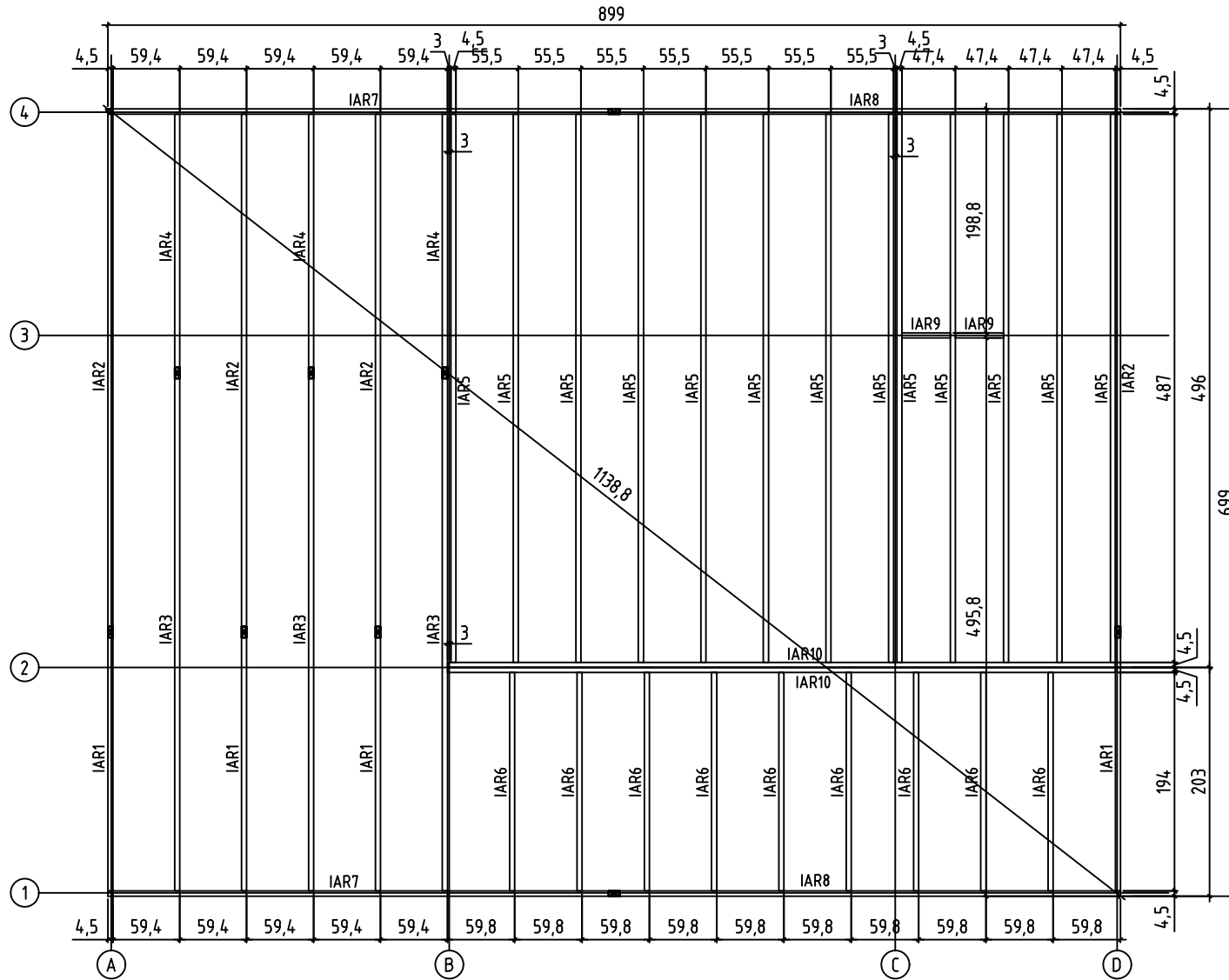

Blue Nile 70, Art.No.703041  
Floor boards - Fussbodenbretter - Plan pose plancher - Pavimento - Vloerhout -  
Põrandalaudis

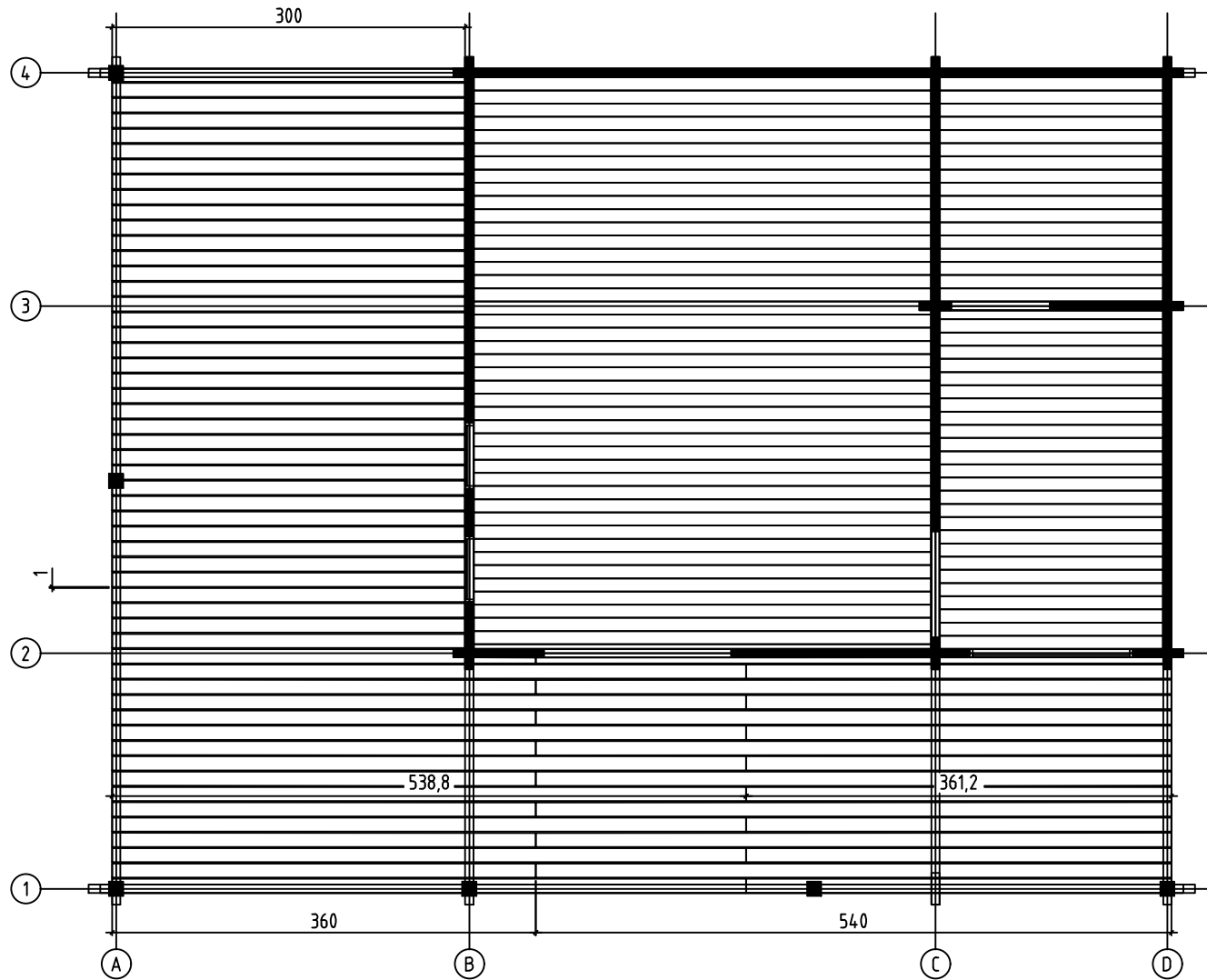

Blue Nile 70, Art.No.703041

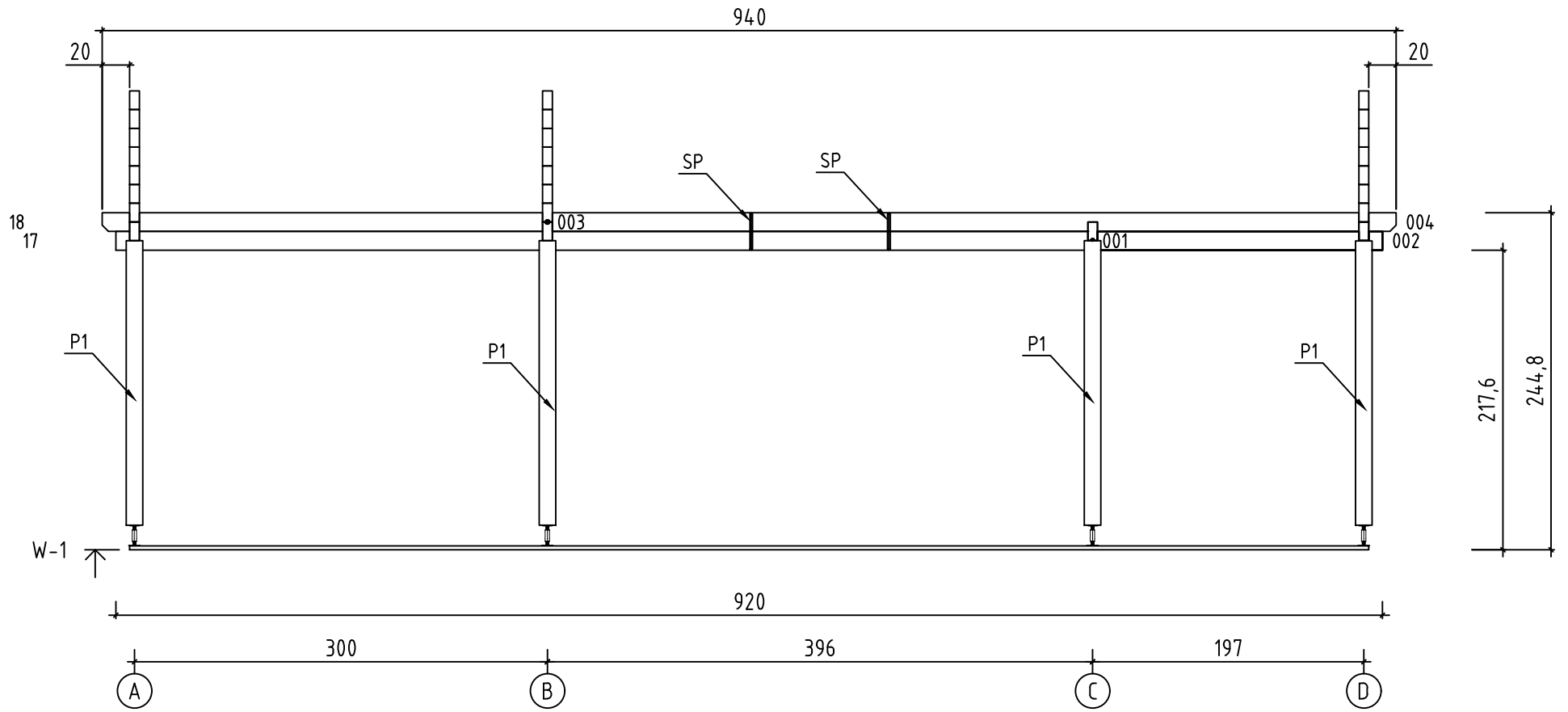

Blue Nile 70, Art.No.703041

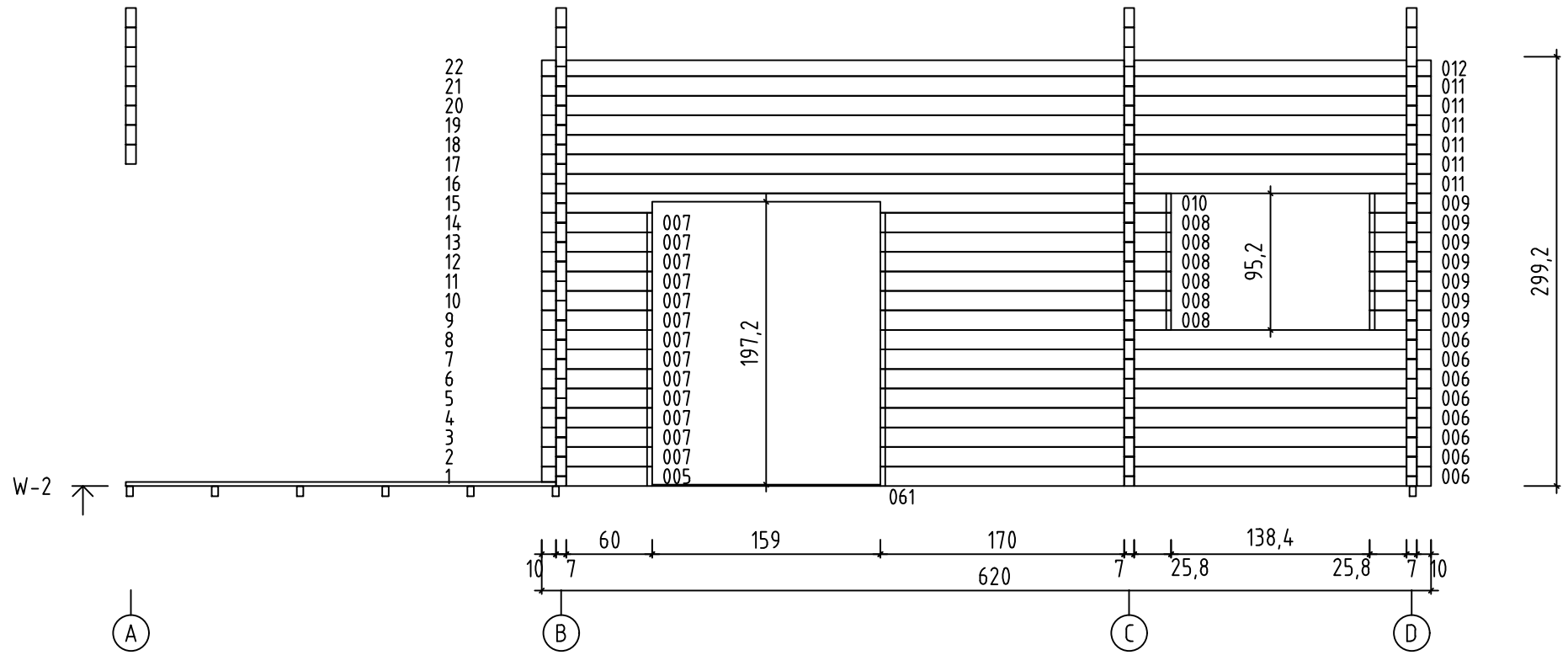

Blue Nile 70, Art.No.703041

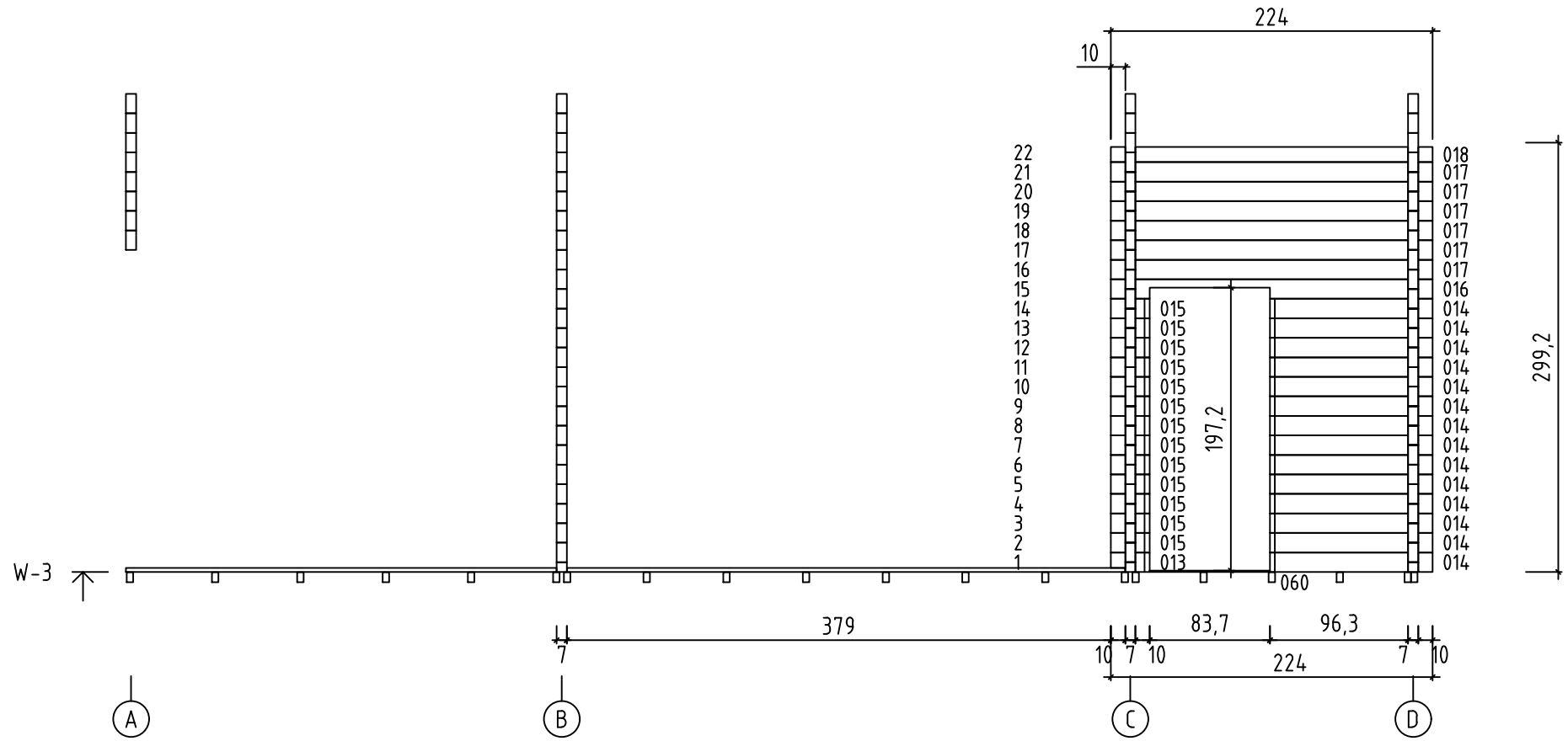

Blue Nile 70, Art.No.703041

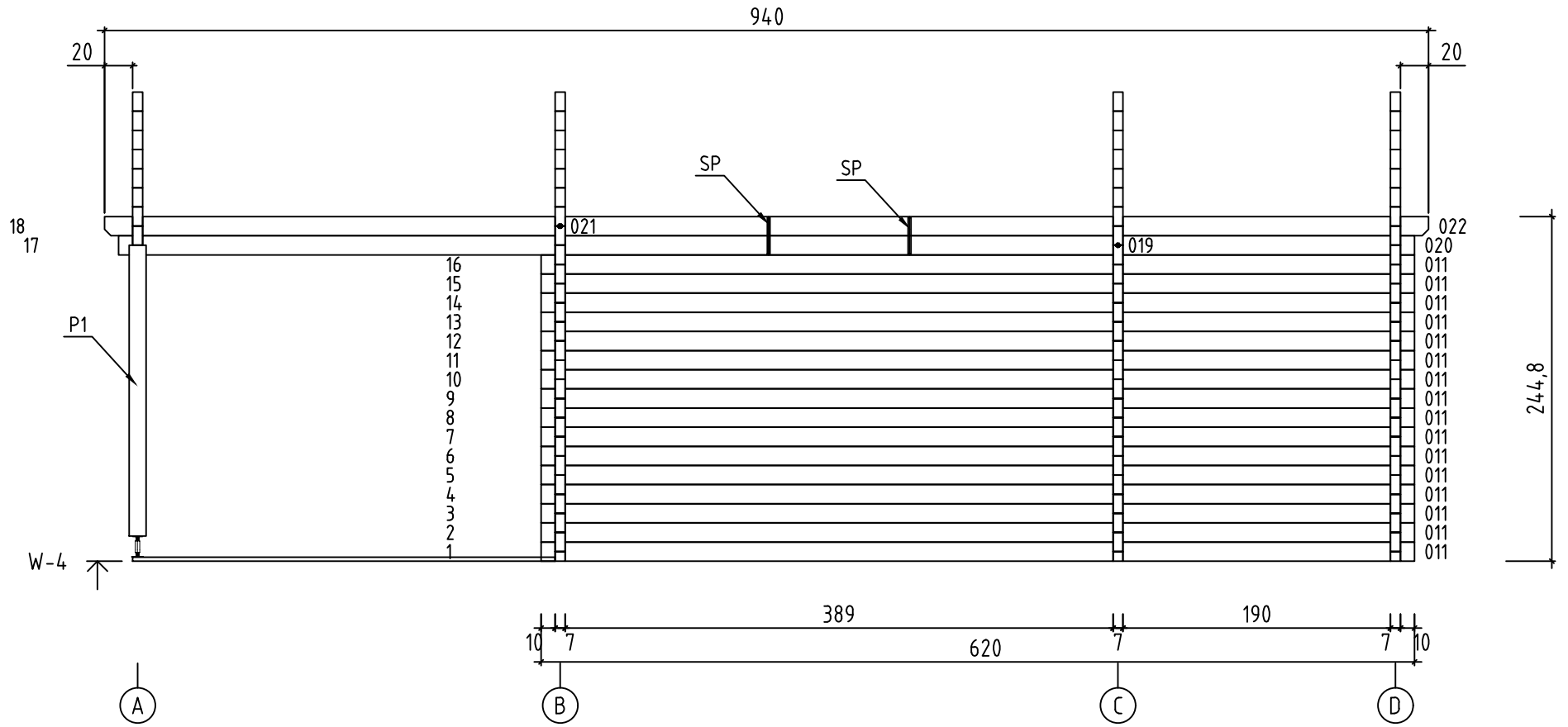

Blue Nile 70, Art.No.703041

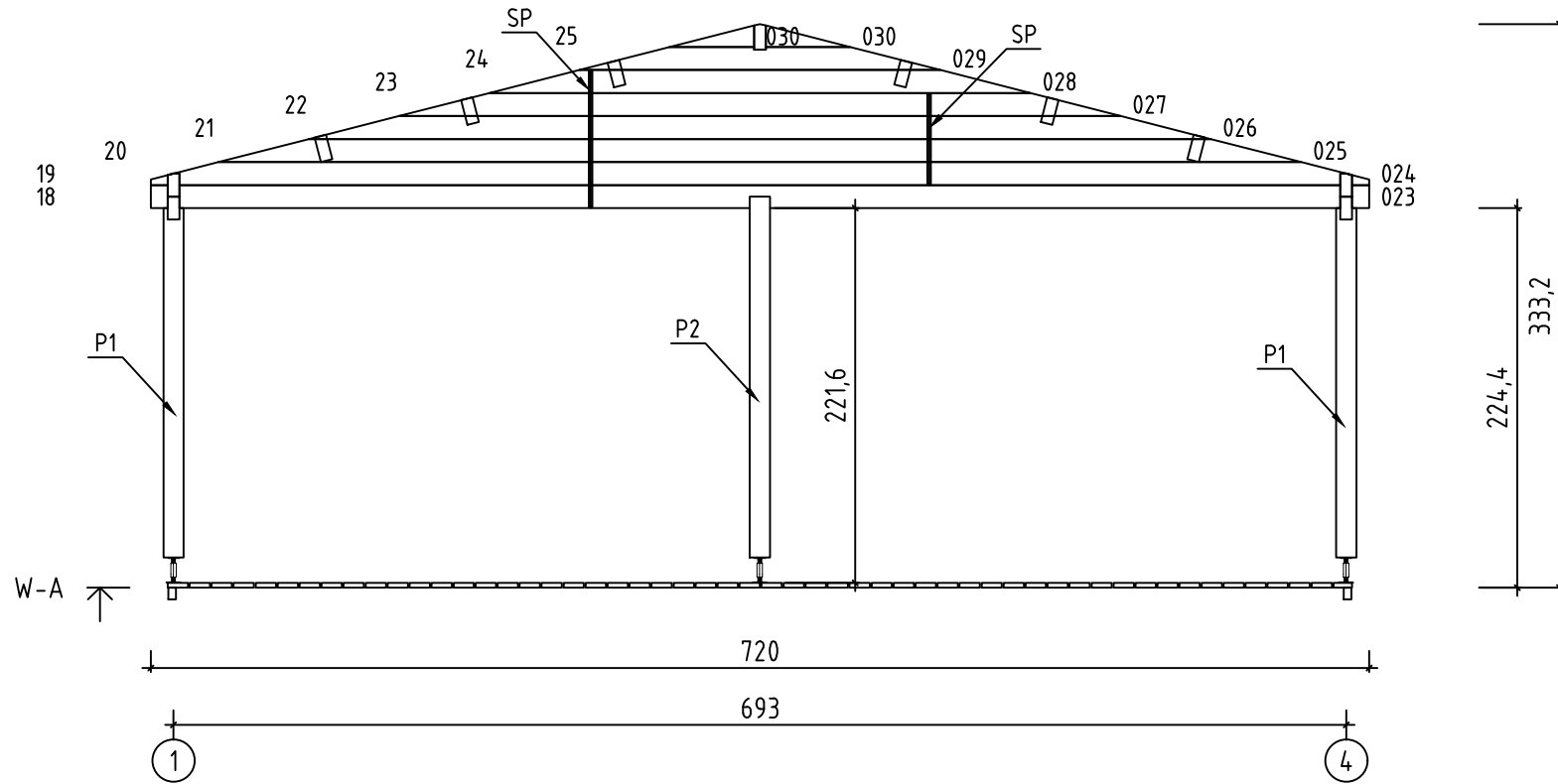



Blue Nile 70, Art.No.703041

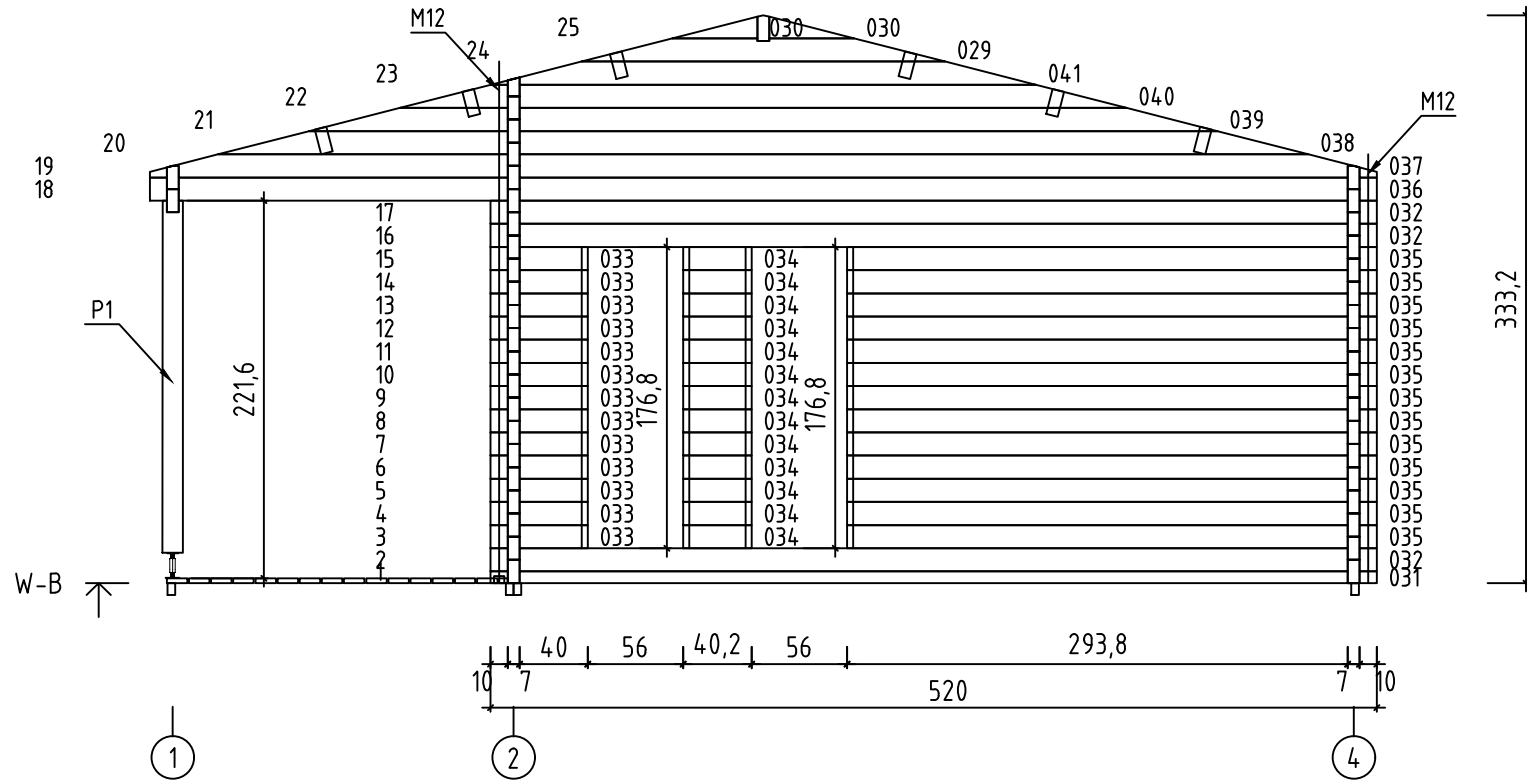



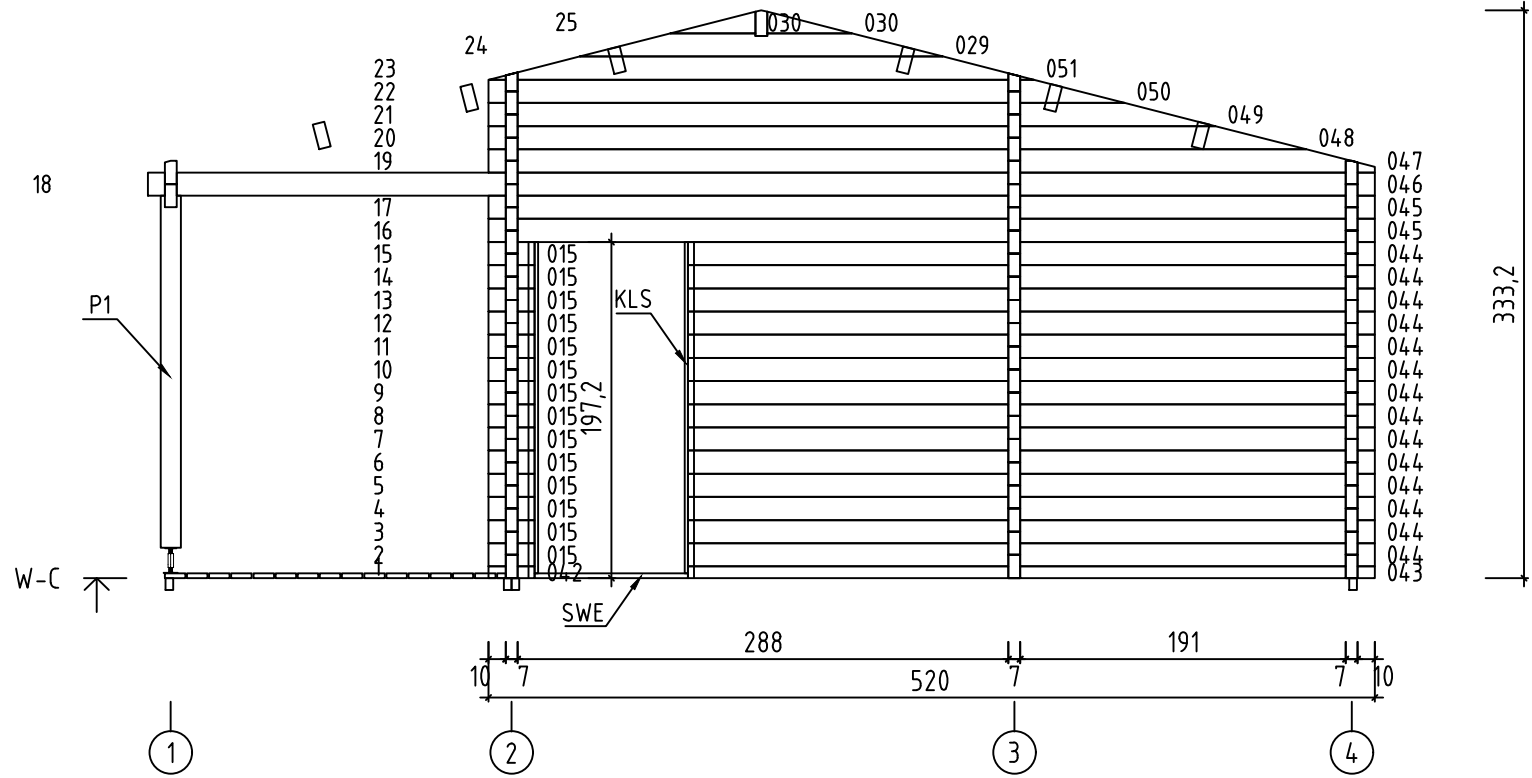



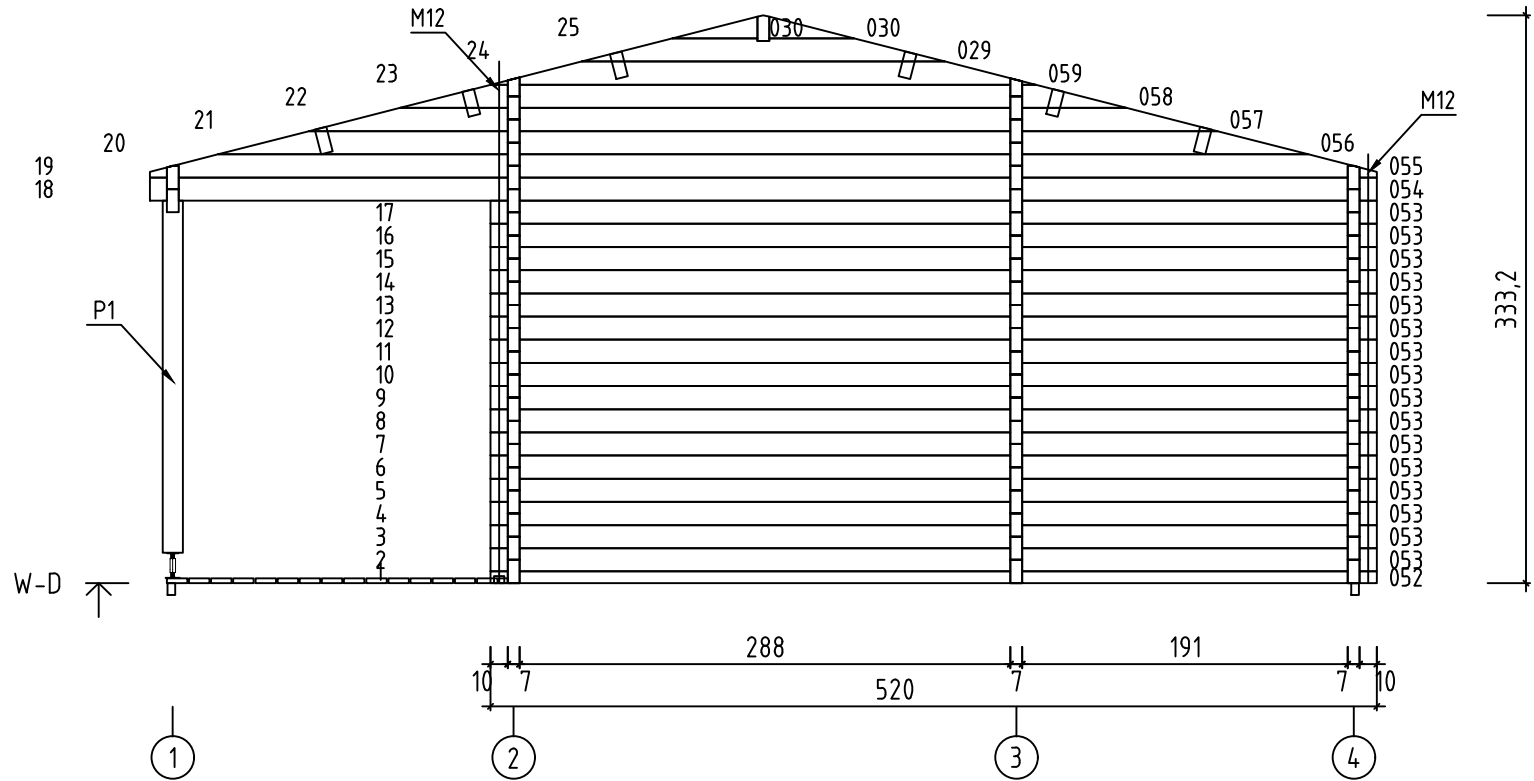

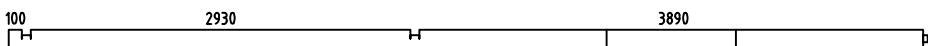
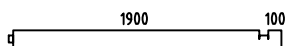
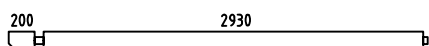
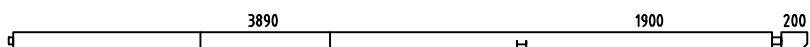
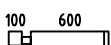
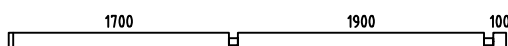
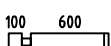
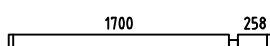

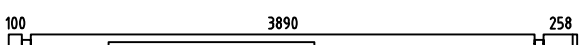
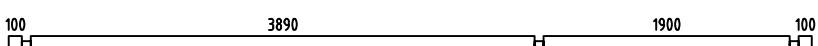
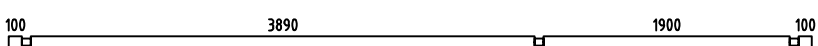

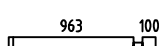

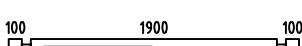
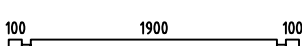
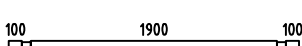
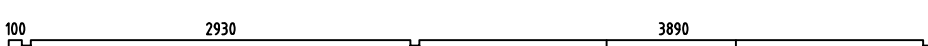
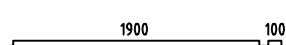
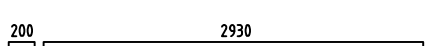
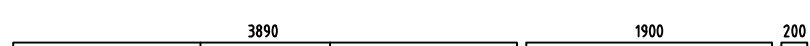
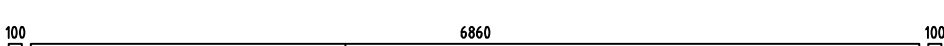
Blue Nile 70, Art.No.703041

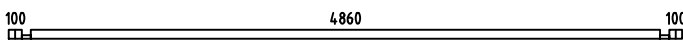
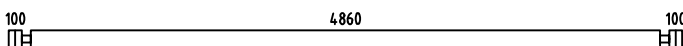

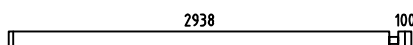
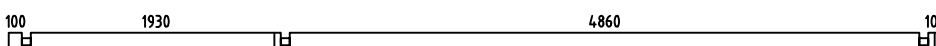

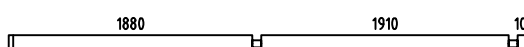
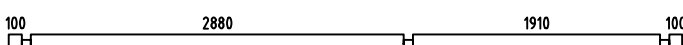
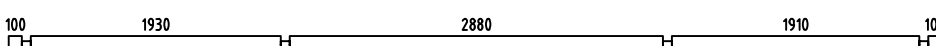

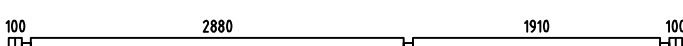
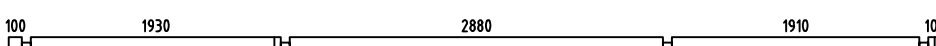

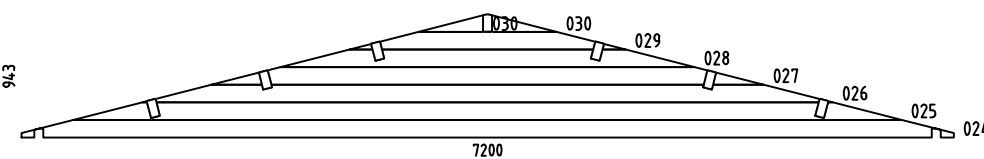
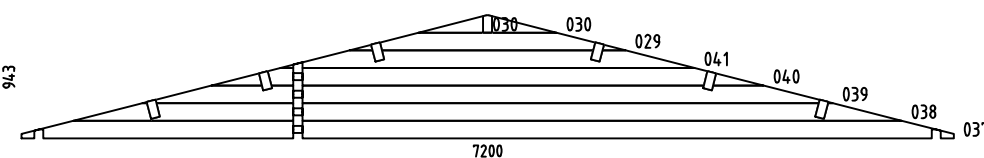
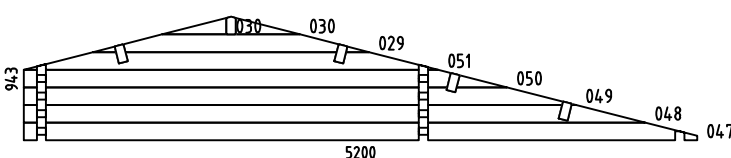

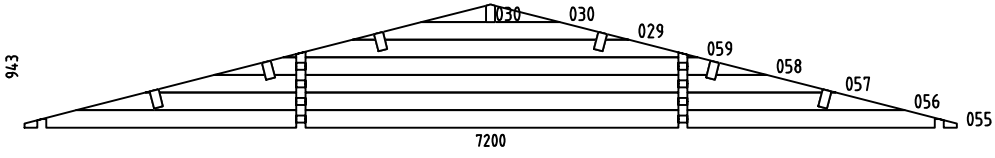
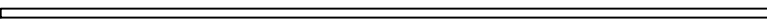
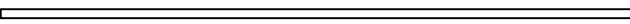
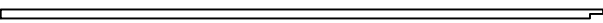
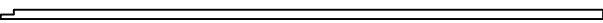
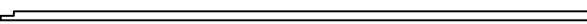
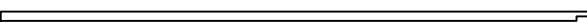
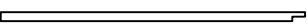
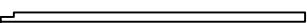
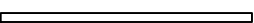

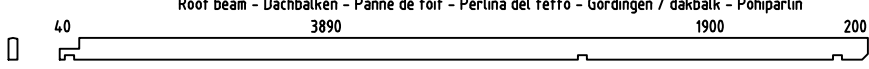
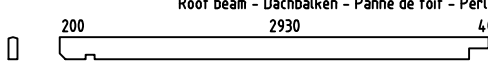
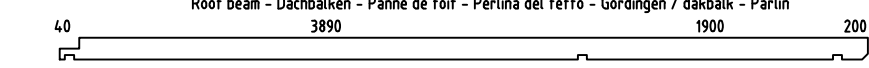
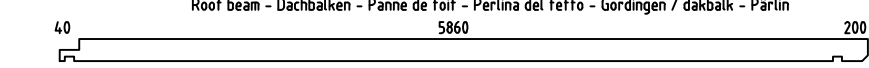
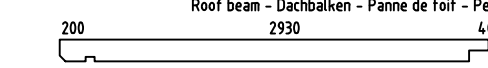
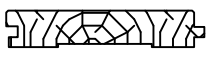











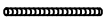
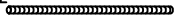

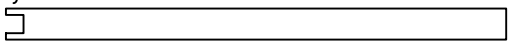
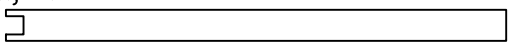
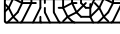

Blue Nile 70, Art.No.703041



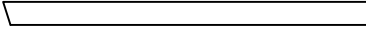















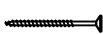

Pos	Blue Nile 70, Art.No.703041 Piece list - Stückliste - Liste des pièces - Elementi - Stuklijst - Tükítabel	Q	P (mm)	L (mm)
001		1	70x136	7095
002		1	70x136	2105
003		1	70x136	3235
004		1	70x136	6165
005		1	70x136	770
006		8	70x136	3840
007		13	70x136	770
008		6	70x136	2028
009		7	70x136	428
010		1	70x136	4388
011		22	70x136	6200
012		1	70x111	6200
013		1	70x136	270
014		14	70x136	1133
015		27	70x136	270
016		1	70x136	2240
017		6	70x136	2240
018		1	70x106	2240
019		1	70x136	7095
020		1	70x136	2105
021		1	70x136	3235
022		1	70x136	6165
023		1	70x136	7200

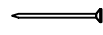

Pos	Blue Nile 70, Art.No.703041 Piece list - Stückliste - Liste des pièces - Elementi - Stuklijst - Tükítabel	Q	P (mm)	L (mm)
031		1	70x68	5200
032		3	70x136	5200
033		13	70x136	570
034		13	70x136	402
035		13	70x136	3108
036		1	70x136	7200
042		1	70x68	270
043		1	70x68	4030
044		14	70x136	4030
045		2	70x136	5200
046		1	70x136	7200
052		1	70x68	5200
053		16	70x136	5200
054		1	70x136	7200
060		1	70x10	837
061		1	70x10	1590
WA-1		1		
WB-1		1		
WC-1		1		

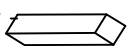
Pos	Blue Nile 70, Art.No.703041 Piece list - Stückliste - Liste des pièces - Elementi - Stuklijst - Tükítabel	Q	P (mm)	L (mm)
WD-1		1		
IAR10	Foundation - Fundament - Fondation - Fondamenta - Fundering - Immutatud alusraam 	2	45x70	5930
IAR5	Foundation - Fundament - Fondation - Fondamenta - Fundering - Immutatud alusraam 	13	45x70	4870
IAR3	Foundation - Fundament - Fondation - Fondamenta - Fundering - Immutatud alusraam 	3	45x70	4650
IAR2	Foundation - Fundament - Fondation - Fondamenta - Fundering - Immutatud alusraam 	4	45x70	4650
IAR8	Foundation - Fundament - Fondation - Fondamenta - Fundering - Immutatud alusraam 	2	45x70	4545
IAR7	Foundation - Fundament - Fondation - Fondamenta - Fundering - Immutatud alusraam 	2	45x70	4545
IAR1	Foundation - Fundament - Fondation - Fondamenta - Fundering - Immutatud alusraam 	4	45x70	2350
IAR4	Foundation - Fundament - Fondation - Fondamenta - Fundering - Immutatud alusraam 	3	45x70	2350
IAR6	Foundation - Fundament - Fondation - Fondamenta - Fundering - Immutatud alusraam 	9	45x70	1940
IAR9	Foundation - Fundament - Fondation - Fondamenta - Fundering - Immutatud alusraam 	2	45x70	429
PR2	Roof beam - Dachbalken - Panne de toit - Perlina del tetto - Gordingen / dakbalk - Põhipärtlin 	1	70x170	6240
PR1	Roof beam - Dachbalken - Panne de toit - Perlina del tetto - Gordingen / dakbalk - Põhipärtlin 	1	70x170	3310
A-PR2	Roof beam - Dachbalken - Panne de toit - Perlina del tetto - Gordingen / dakbalk - Pärtlin 	4	70x170	6240
A-PR3	Roof beam - Dachbalken - Panne de toit - Perlina del tetto - Gordingen / dakbalk - Pärtlin 	2	70x170	6240
A-PR1	Roof beam - Dachbalken - Panne de toit - Perlina del tetto - Gordingen / dakbalk - Pärtlin 	6	70x170	3310
HLL-1	Floor boards - Fussbodenbretter - Lame de plancher - Pavimento - Vloerhout - Põrandalaud 		137x28	226 m.
	Roof boards - Dachbretter - Voliges - Perlina per tetto - Dakhout - Katuselaud 	210	90x18	3900
SV2	Terrace boards - Terrassenbretter - Plancher de terrasse - Piattaforme terrazzo - Terrasvloer - Terrassilaud 	8	120x28	5400
SV2	Terrace boards - Terrassenbretter - Plancher de terrasse - Piattaforme terrazzo - Terrasvloer - Terrassilaud 	8	120x28	5388
SV2	Terrace boards - Terrassenbretter - Plancher de terrasse - Piattaforme terrazzo - Terrasvloer - Terrassilaud 	8	120x28	3612
SV2	Terrace boards - Terrassenbretter - Plancher de terrasse - Piattaforme terrazzo - Terrasvloer - Terrassilaud 	8	120x28	3600

Pos	Blue Nile 70, Art.No.703041 Piece list - Stückliste - Liste des pièces - Elementi - Stuklijst - Tükítabel	Q	P (mm)	L (mm)
SV2-5	Terrace boards - Terrassenbretter - Plancher de terrasse - Piattaforme terrazzo - Terrasvloer - Terrassilaud 	38	120x28	3000
FL-1	Floor fillet - Fussbodenleiste - Corniere de finition du plancher - Finitura per pavimento (battisco pa) - Vloerafwerklíjst - Pörandaliist 		15x40	35 m.
KLS	Batten - Deckleiste - Profils de finition angles a l'exterieur - Asse - Afdek líjst - Katteliist 	2	18x70	1950
DPL-1	Roofing felt fillet - Dachpappenleiste - Baguette de fixation du feutre bitumeux - Asse per fissaggio guaina bituminosa - Afdeklíjst asfaltpapier - Katusepapiilist 	4	18x58	3950
M12	Treaded rod m12 - Gewindestange m12 - Tige filetée m12 - Barra filettata passo m12 - Draadstang 12m - Keermelatt 	2		455
M12	Treaded rod m12 - Gewindestange m12 - Tige filetée m12 - Barra filettata passo m12 - Draadstang 12m - Keermelatt 	2		925
M12	Treaded rod m12 - Gewindestange m12 - Tige filetée m12 - Barra filettata passo m12 - Draadstang 12m - Keermelatt 	4		2000
SWE1	Doorstep - Swelle - Seuil de porte - Callare - DrempeL - Lävepak kseavale 	1	28x74	900
P1	Post - Pfosten - Poteau - Piede registrabile - Stíjl - Post 	5	120x120	2065
P2	Post - Pfosten - Poteau - Piede registrabile - Stíjl - Post 	1	120x120	2130
TB	Fascia board - Traufbrett - Bandeau de toit - Finitura lati tetto - Gevellíjst - Räästalaud 	4	18x90	4700
DRV	Roof edge reinforcement - Dachrandverstärkung - Corniere de renfort de bord de toit - Rinforzo x tetto - Dakrand versterking - Räästafugevdus 	4	28x34	4700
TBE12	Fixing fillet - Fixierungsleiste - Profil de fixation - Massello di fissaggio - Bevestiging líjstwerk - Tenderlíjst 	2	28x34	1970
TBE6	Fixing fillet - Fixierungsleiste - Profil de fixation - Massello di fissaggio - Bevestiging líjstwerk - Tenderlíjst 	2	28x34	916
TBE6	Fixing fillet - Fixierungsleiste - Profil de fixation - Massello di fissaggio - Bevestiging líjstwerk - Tenderlíjst 	4	28x34	1729
TBE6	Fixing fillet - Fixierungsleiste - Profil de fixation - Massello di fissaggio - Bevestiging líjstwerk - Tenderlíjst 	4	28x34	1826
GL	Gable moulding - Giebelleiste - Planche de rive - Finitura per frontale e retro del tetto - Gevellíjst - Viilulaud 	4	18x120	3950
KL4	Lengthening bolt for treaded rod - Verlängerungsmutter für gewindestange - Manchon de raccordement de tige filetée - Bullone per barra filettata passo - Extensie moer voor draadstang - Jätkumutter keermelatile 	4		
KL1	Drive nut treaded rod - Einschlagmutter für gewindestange - Écrou a frapper pour tige filitée - Dado guida per barra filettata - Aandrijfmoer / aanslagmoer voor draadstang - Löökmutter keermelatile 	4		
KL2	Nut for treaded rod - Mutter für gewindestange - Écrou pour tige filetée - Dado per barra filettata - Moer voor draadstang - Mutter keermelatile 	4		
KL3	Plain washer treaded rod - Unterlegscheibe für gewindestange - Rondelle plate pour tige filetée - Rondella per barra filettata - Sluiring voor draadeind - Seib keermelatile 	4		
HS12	Screw for gable segment - Schrauben für deckblatt - Vis pour fixation losange de finition - Viti x frontali tetto - Schroef voor gevelpunt segment - Kruvi rombile 	4	3.5x35	
HS11	Screw for covering moulding - Schrauben für deckungsprofil - Vis de fixation profils horizontaux haut intérieur et extérieur d'encadrement de porte - Vite per cornice di copertura - Schroef voor afdekprofiel - Kruvi piirdelauale 	10	3.5x50	

Pos	Blue Nile 70, Art.No.703041 Piece list - Stückliste - Liste des pièces - Elementi - Stuklijst - Tükítabel	Q	P (mm)	L (mm)
HS25	Screw for floor - Schrauben für fussbodenbretter - Vis pour plancher - Viti per le perline del pavimento - Schroef voor vloerhout - Kruvi põrandale 	590	3.5x50	
HS84	Screw for fixing fillet of door and window - Schrauben für fixierungsleiste - Vis pour profil vertical de fixation pour ouvertures des fenetres et portes - Viti per massello di fissaggio - Schroeven voor bevestiging van deur en raam lijsten - Kruvi tenderliistudele 	56	3.5x50	
HS16	Screw for gable moulding - Schrauben für giebelleiste - Vis pour fixation planche de rive - Vite per fissare finiture davanti e dietro del tetto - Schroef voor gevellijst - Kruvi viilulauale 	40	3.5x50	
HS32	Screw for fascia boards - Schrauben für traufbretter - Vis pour fixation bandeau de toit - Viti x striscia del tetto - Schroef voor gevellijst - Kruvi räästalauale 	36	4x40	
HS26	Screw for roof edge reinforcement - Schrauben für dachrandverstärkung - Vis pour fixation corniere renfort de bord de toit - Viti x rinforzo bordo tetto - Schroef voor dakrand versterking - Kruvi räästatugevdusele 	36	4x40	
HS34	Screw for post - Schrauben für pfosten - Vis de fixation des poteaux - Viti per inviare - Schroef voor stijlen - Kruvi postile 	12	4x60	
HS35	Screw for doorstep - Schrauben für swelle - Vis pour fixation barre de seuil - Vite per soglia della porta - Schroef voor deurdorpel - Kruvi lävepakule 	5	4x60	
HS40	Screw for 1. wall beam - Schraube für 1. bohnenreihe - Vis de fixations 1ere rangée de madriers avec poutrelles de fondations - Vite fissaggio alle fondamenta - Schroef voor 1 wandbalk - Kruvi poollalaule 	15	5x120	
HS42	Screw for gable - Schrauben für giebel - Vis pour fixation des pignons - Viti per timpano - Schroef voor gevelpunt - Kruvi kelba kinnitamiseks 	56	5x120	
HS43	Screw for roof beams - Schrauben für dachbalken - Vis pour fixation pannes de toit - Viti per perline del tetto - Schroef voor gordingen / dakbalken - Kruvi pärlinitele 	28	5x120	
HS39	Screw for foundation - Schrauben zur befestigung fundament - Vis de fixations des poutrelles de fondations - Viti x fondamenta - Schroef voor fundering - Kruvi alusraamile 	93	5x90	
HS49	Screw for post height adjustment - Schrauben für regulierungsschraube für pfosten - Vis de fixation de support réglable de poteau - Viti per fissare ed aggiustare l'altezza del palo verticale - Schroef voor hoogte instelling stijlen - Kruvi vajumispolidile 	48	6x50	
NF3	Screw for terrace - Schrauben für terrassenbretter - Vis pour fixation de terrasse - Viti per terrazza - Schroef voor terrasvloer - Kruvi terrassilauale 	1000	4.2x55	
SH70	Hammer block - Schlagholz - Calle de frappe - Blocco di legno da usare come cuscinetto quando si usa il martello - Slagklos - Löögiklots 	2		
NFD	Zn nail for roofing felt fillet - Zn nagel für dachpappenleiste - Pointe pour baguette de fixation feutre bitumeux - Chiodi x carta bituminosa x tetto - Spijker(nagel) voor asfaltpapier afdeklijst - Papiliistunael 	36	2x40	
NFF	Zn nail for floor fillet - Zn nagel für fussbodenleiste - Pointe pour corniere de finition du plancher - Chiodi x fissaggio pavimento - Spijker(nagel) voor vloer afdeklijst - Nael põrandaliistule 	70	1.4x40	
NF2	Zn nail for roof - Zn nagel für dachbretter - Pointe pour fixation voliges de toit - Chiodi x perline tetto - Spijker(nagel) voor dakhout - Nael katuselauale 	1095	2.1x50	
ORZ	Montage set for doors and windows - Montage set für türen und fenster - Jeu de montage portes et fenetres - Set di assemblaggio per porte e finestre - Montage set voor deur en raam - Orthez akna ja ukse montaaživahendid	1		
GS	Gable segment - Deckblatt - Losange de finition - Decorazione in legno x frontale tetto - Gevelpunt segment - Romb 	2		
SP1	Hidden fixing - Holzdübel - Tourillon bois - Fissaggio a scomparsa - Verloren kop spijker - Salapulk 	9		
RFP	Post height adjustment - Pfostenträger verstellbar - Support réglable de poteau - Piede registrabile in altezza - Stelschroef voor stijlpost - Vajumispolt 	6		

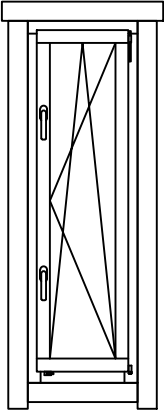
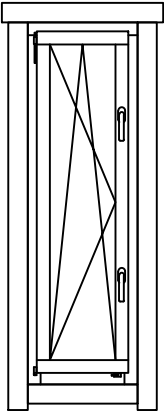
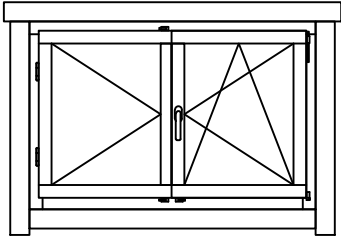

Pos	<p style="text-align: center;">Blue Nile 70, Art.No.703041</p> <p style="text-align: center;">Piece list - Stückliste - Liste des pièces - Elementi - Stuklijst - Tükítabel</p>	Q	P (mm)	L (mm)
	<p>Window - Fenster - Fenetre - Finestra - Raam - Aken <span style="float: right;">552x1729 2+ A.0P.b</span></p> 	1		
	<p>Window - Fenster - Fenetre - Finestra - Raam - Aken <span style="float: right;">552x1729 2+ A.0V.b</span></p> 	1		
	<p>Window - Fenster - Fenetre - Finestra - Raam - Aken <span style="float: right;">1374x916 2+ TA.0P</span></p> 	1		
	<p>Door - Tür - Porte - Porte - Deur - Uks <span style="float: right;">1580x1933 2+ TU.10P</span></p> 	1		



