

Art. Nr. 4429719

Groundplan - Grundplan - Plan de masse -
Planimetria - Plattegrond - Põhiplaan

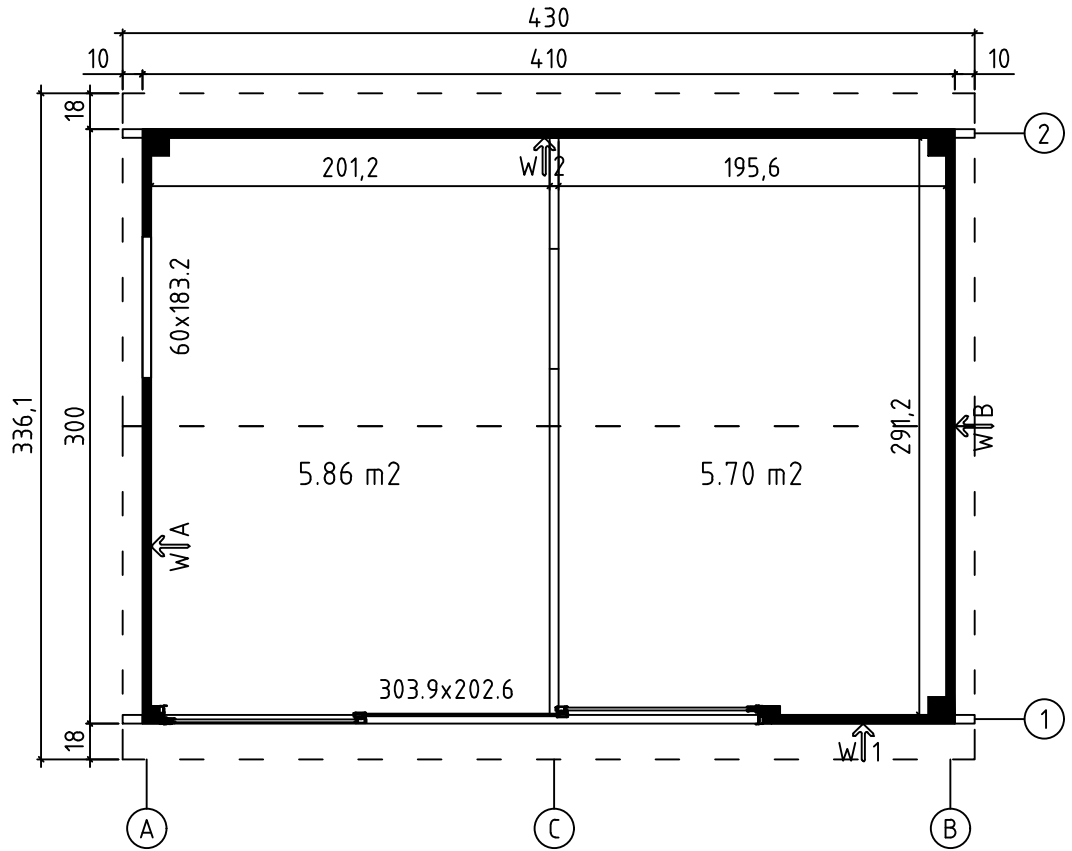

Foundation - Fundament - Fondation - Fondamenta - Fundering -
Immutatud alusraam

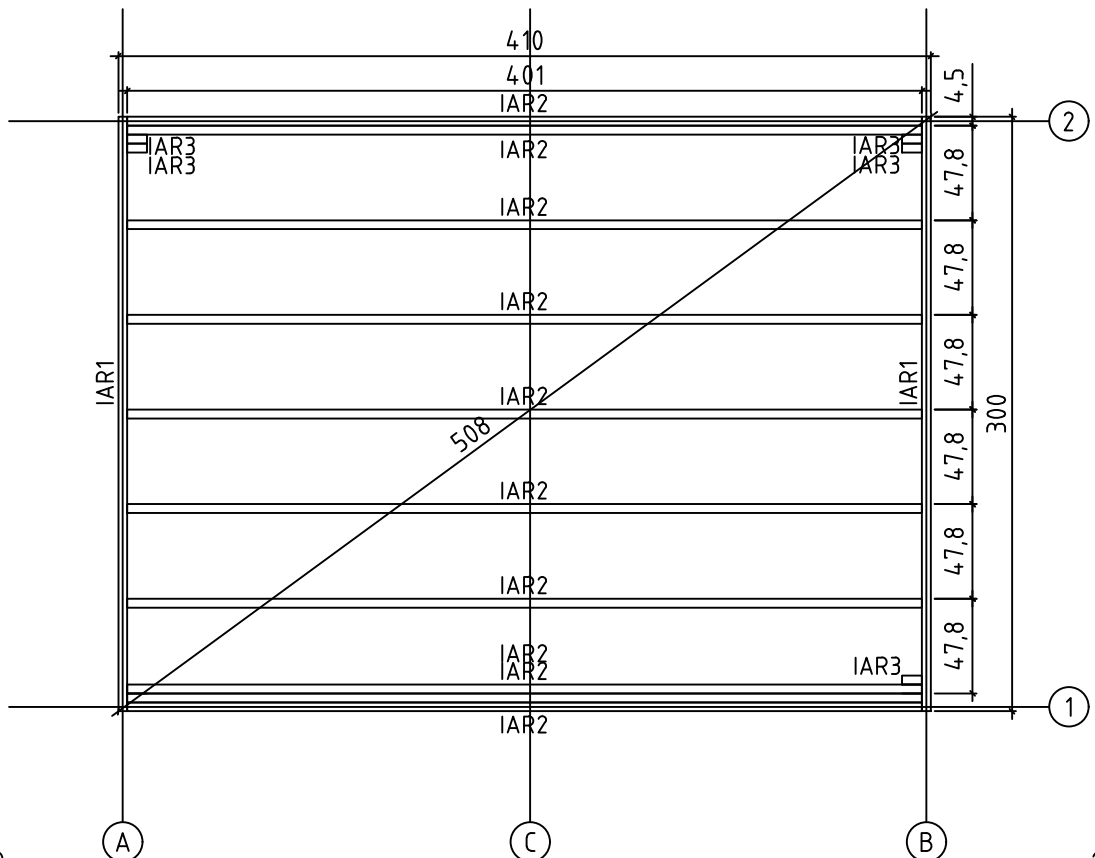

Floor boards - Fussbodenbretter - Plan pose plancher - Pavimento -
Vloerhout - Põrandalaudis

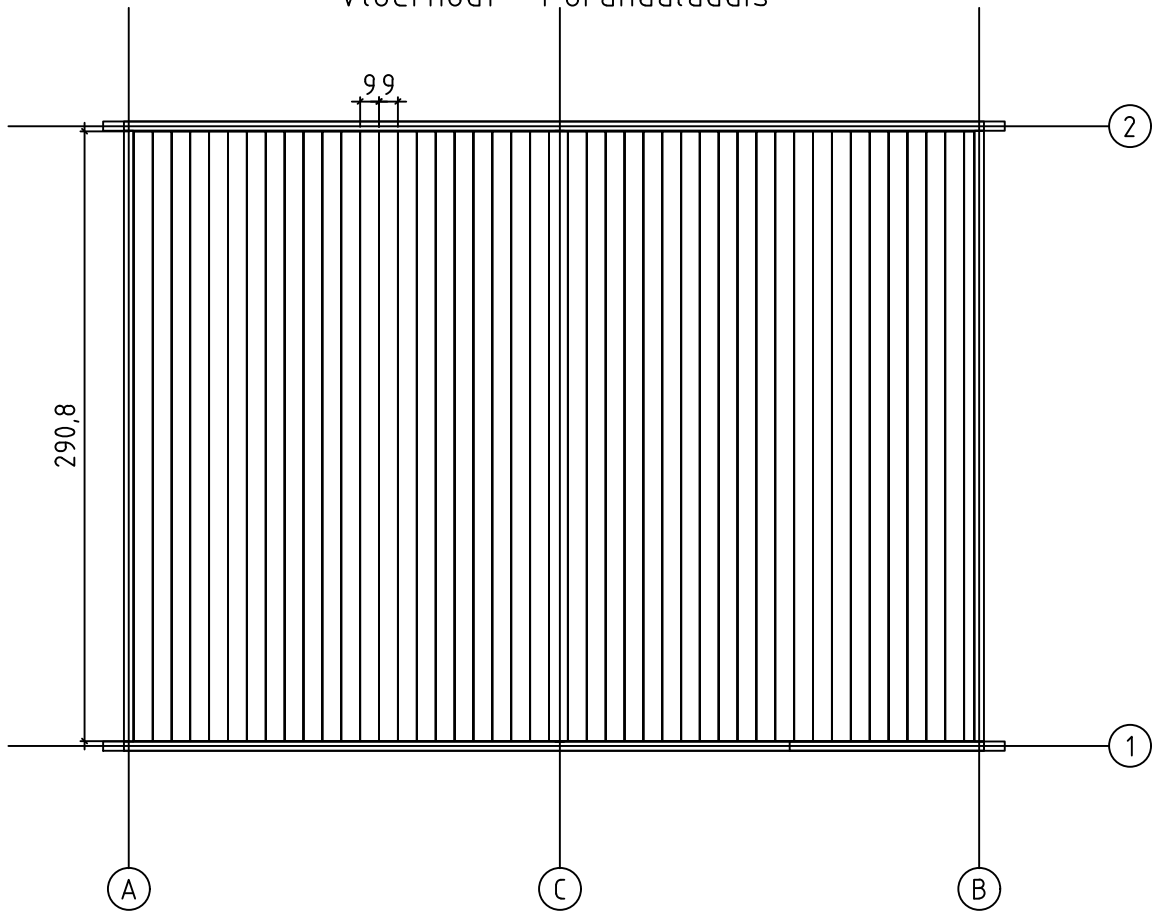

Floor boards - Fussbodenbretter - Plan pose plancher - Pavimento -
Vloerhout - Põrandalaudis

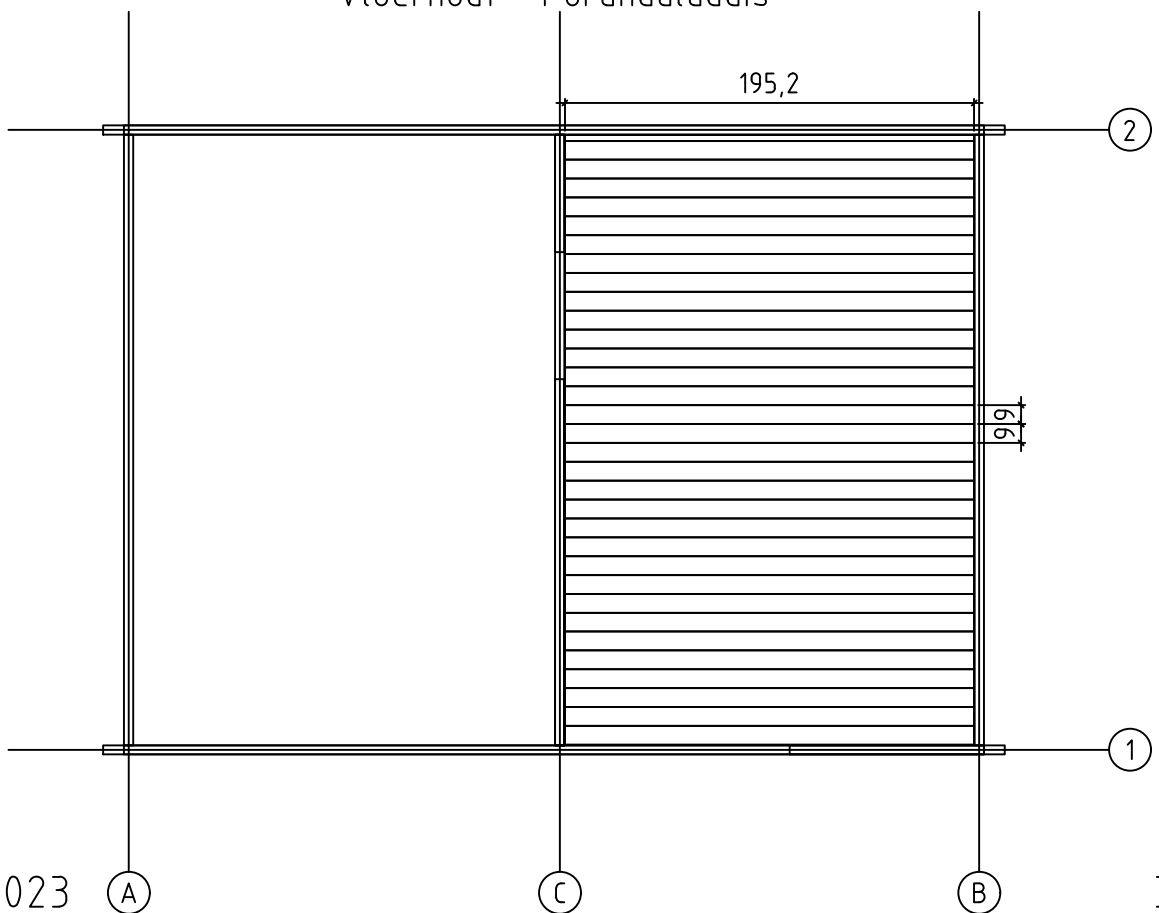



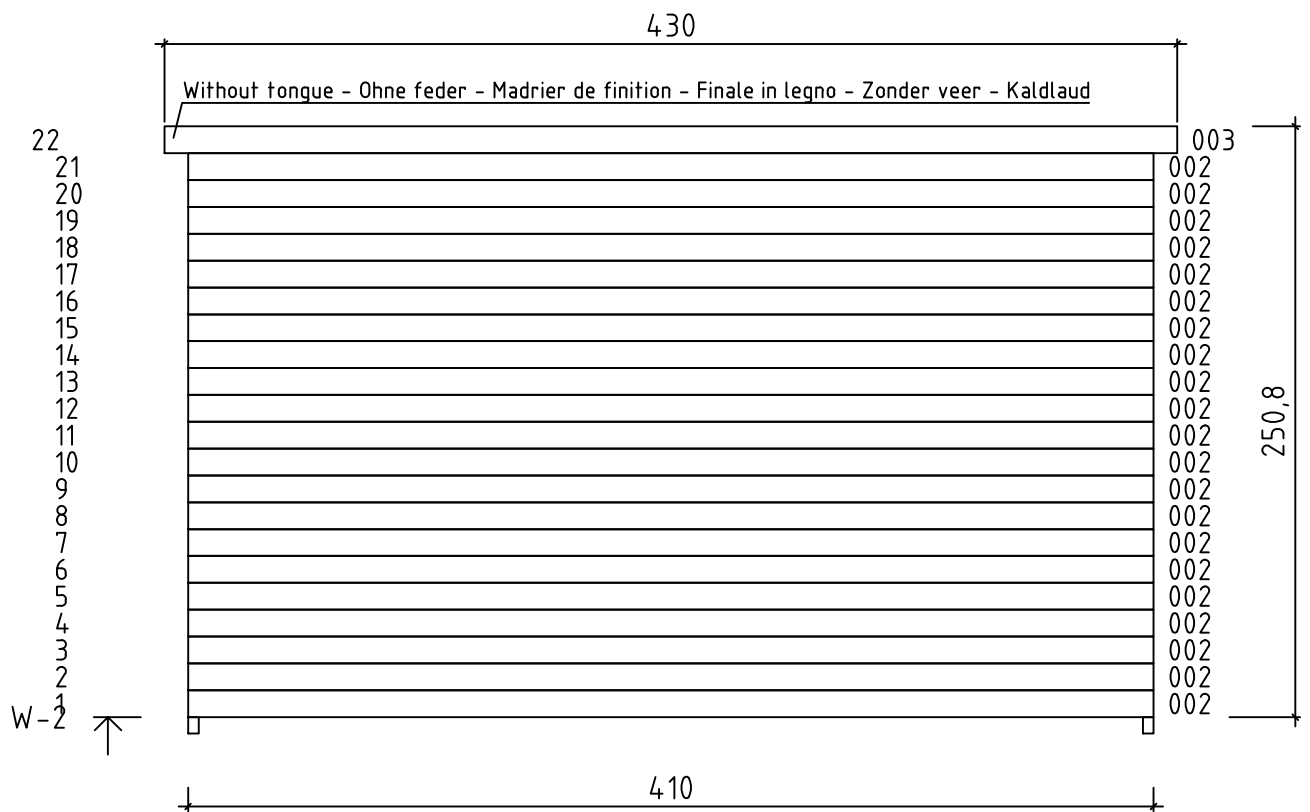
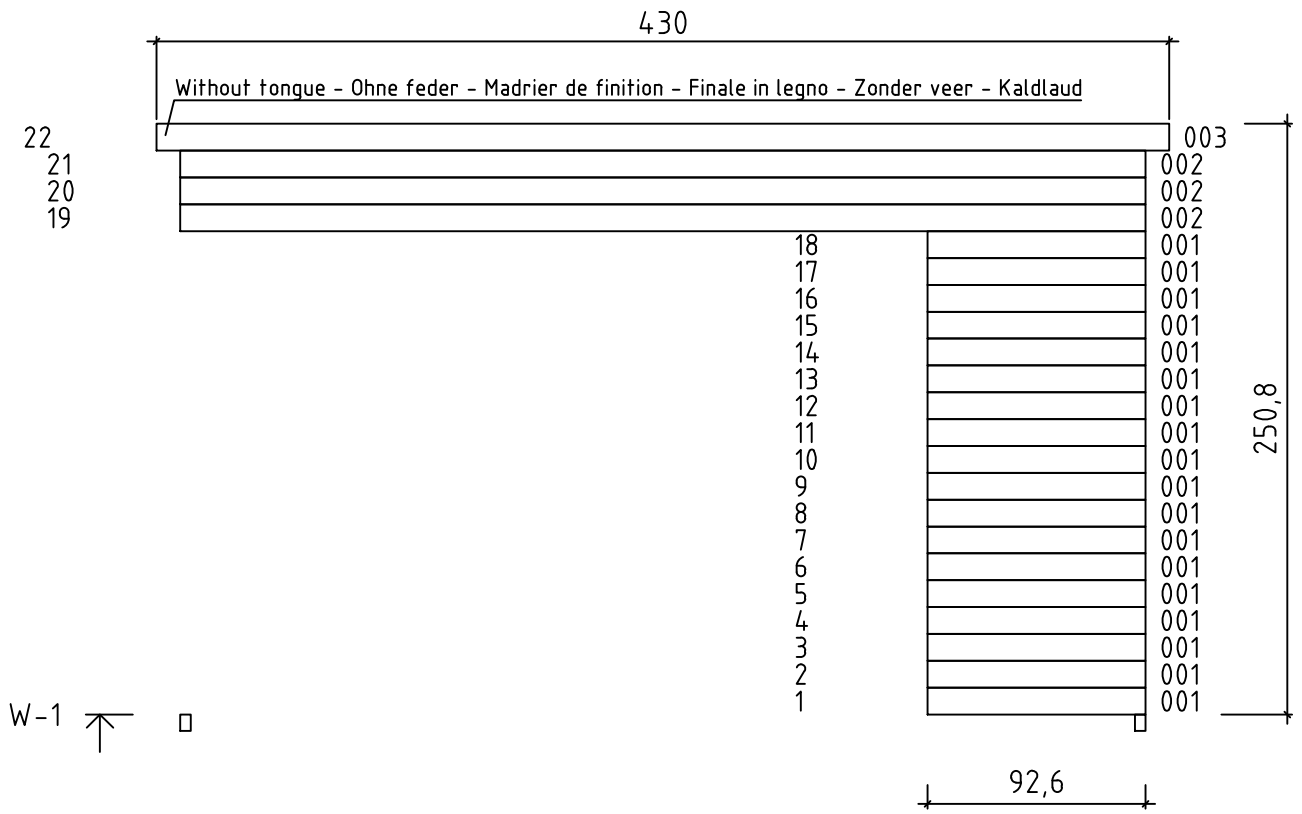



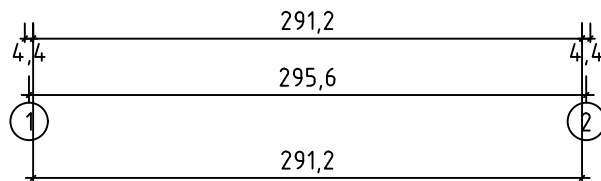
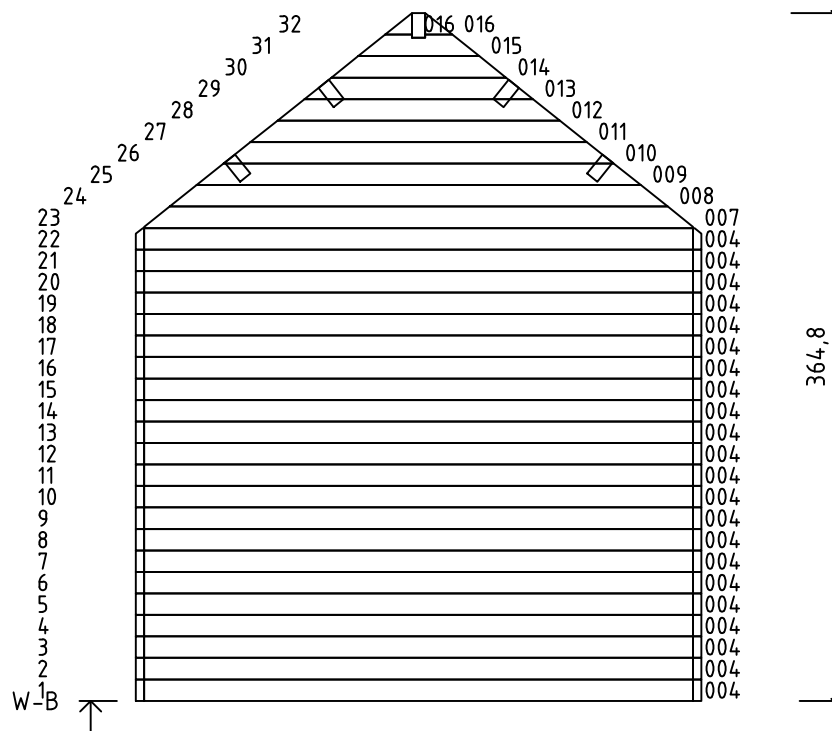
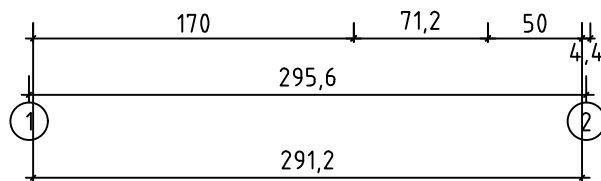
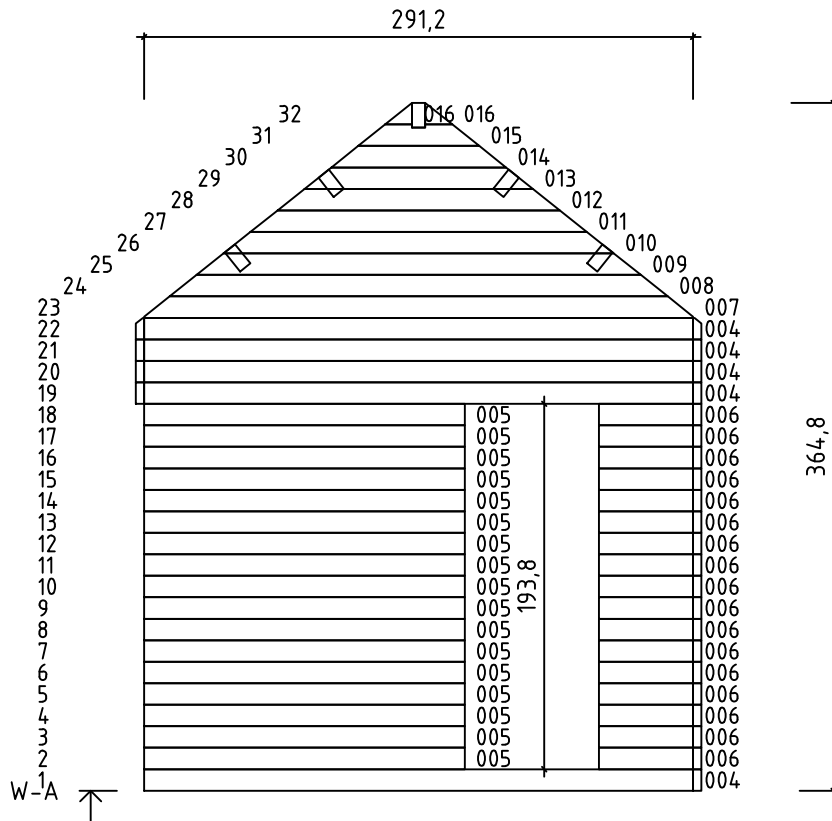

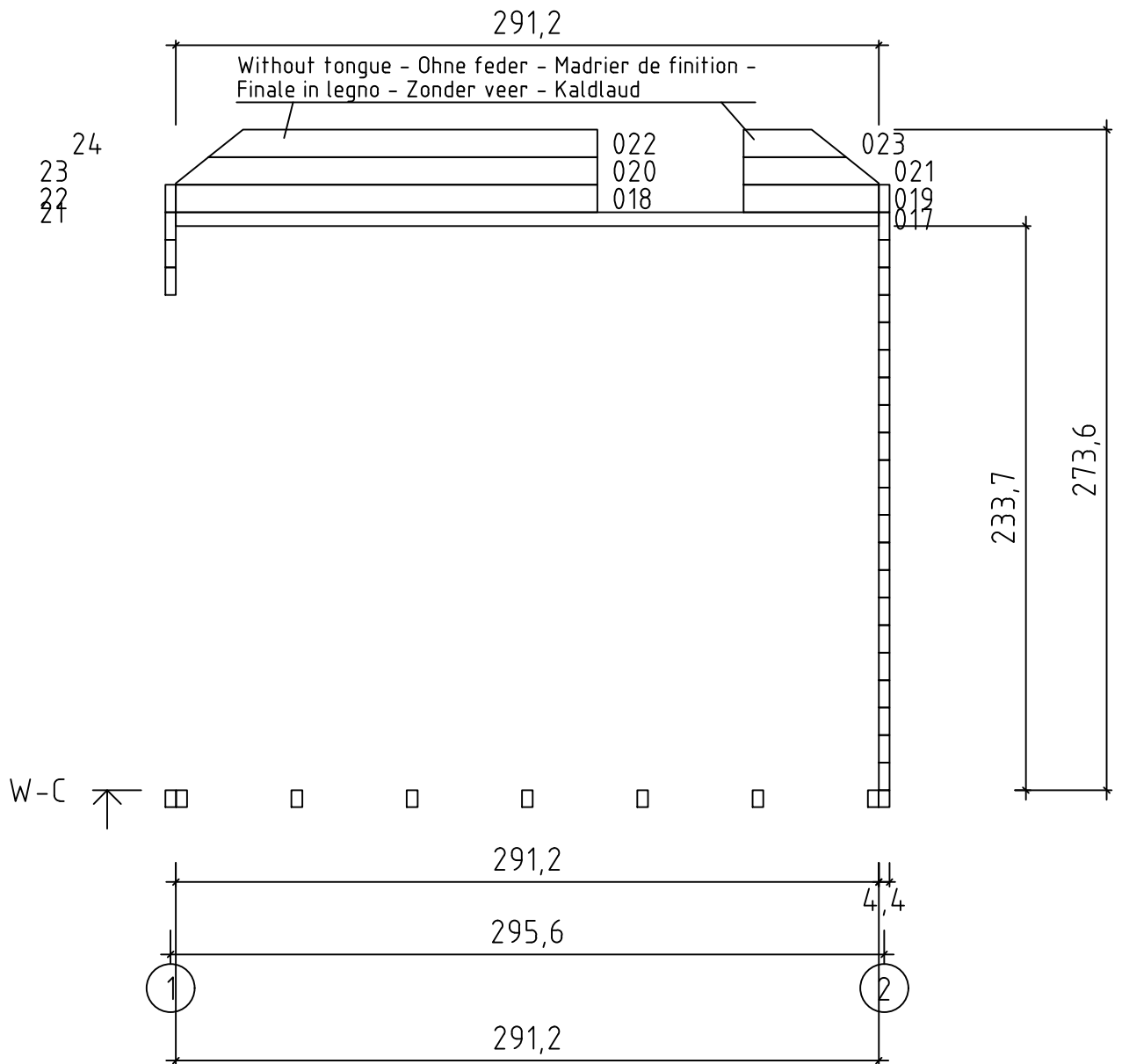

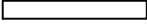
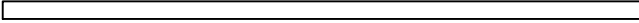
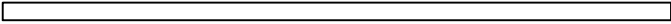
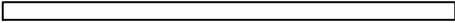
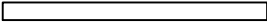
Art. Nr. 4429719

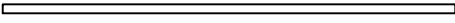
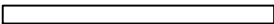

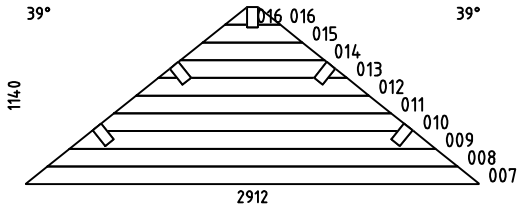
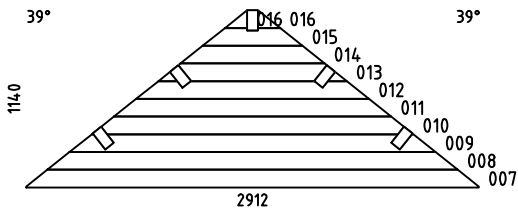



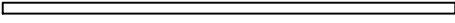
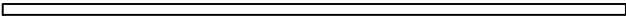
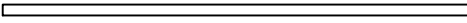





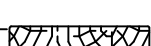





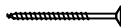
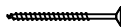
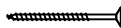
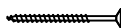
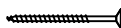
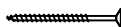
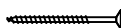
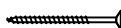

Art. Nr. 4429719

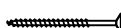



Pos	18.04.2023 Piece list - Stückliste - Liste des pièces - Elementi - Stuklijst - Tükitalad Art. Nr. 4429719 7/23	Q	P (mm)	L (mm)
001 44300		18	44x114	926
002 44301		24	44x114	4100
003 44303	D 	2	44x120	4300
004 21421		27	44x114	2912
005 44304		17	44x114	1700
006 28276		17	44x114	500
017 35705		1	44x57	2912
018 44305		1	44x114	1746
019 22605		1	44x114	560
WA-1 44306		1		
WB-1 44306		1		
WC-1		1		
VT1 35708	Mezzanine floor joists - Halbgeschoss balken - Solives de plancher mezzanine - Travi del pavimento mezzanino - Plaatduim scharnier - Vahelaetalad 	5	44x140	2912
VT3 44330	Mezzanine floor joists - Halbgeschoss balken - Solives de plancher mezzanine - Travi del pavimento mezzanino - Plaatduim scharnier - Vahelaetalad 	1	44x140	2732
VT4 44331	Mezzanine floor joists - Halbgeschoss balken - Solives de plancher mezzanine - Travi del pavimento mezzanino - Plaatduim scharnier - Vahelaetalad 	2	44x140	1910
VT2 45756	Mezzanine floor joists - Halbgeschoss balken - Solives de plancher mezzanine - Travi del pavimento mezzanino - Plaatduim scharnier - Vahelaetalad 	1	44x70	2912
IAR2 44307	Foundation - Fundament - Fondation - Fondamenta - Fundering - Immutatud alusraam 	10	45x70	4010
IAR1 37391	Foundation - Fundament - Fondation - Fondamenta - Fundering - Immutatud alusraam 	2	45x70	3000
IAR3 34041	Foundation - Fundament - Fondation - Fondamenta - Fundering - Immutatud alusraam 	5	45x70	100

Pos	18.04.2023 Piece list - Stückliste - Liste des pièces - Elementi - Stuklijst - Tükítabel Art. Nr. 4429719 8/23	Q	P (mm)	L (mm)
A-PR1 44332	Roof beam - Dachbalken - Panne de toit - Perlina del tetto - Gordingen / dakbalk - Pärтин 	5	70x140	4300
FB1 1518	Floor boards - Fussbodenbretter - Lame de plancher - Pavimento - Vloerhout - Pörandalaud 	45	90x18	2908
FB2 21451	Floor boards - Fussbodenbretter - Lame de plancher - Pavimento - Vloerhout - Pörandalaud 	33	90x18	1952
RB 36628	Roof boards - Dachbretter - Voliges - Perlina per tetto - Dakhout - Katuselaud 	96	90x18	2150
30087	Floor fillet - Fussbodenteiste - Corniere de finition du plancher - Finitura per pavimento (battisco pa) - Vloerafwerklijst - Pörandaliist 		18x18	25
RFF 14953	Roofing felt fillet - Dachpappenleiste - Baguette de fixation du feutre bitumeux - Asse per fissaggio guaina bituminosa - Afdekljst asfaltpapier - Katusepapiiist 	4	18x58	2200
TL1 43512	Covering moulding - Deckungsprofil - Profils de finition verticaux a fixer a l'exterieur du cadre de la porte - Cornice di finitura - Afdek profiel - Lengipuu 	2	38x46	612
TL2 42950	Covering moulding - Deckungsprofil - Profils de finition verticaux a fixer a l'exterieur du cadre de la porte - Cornice di finitura - Afdek profiel - Lengipuu 	2	38x46	1900
FF1 38454	Fixing fillet - Fixierungsleiste - Profil de fixation - Massello di fissaggio - Bevestiging lijstwerk - Tenderliist 	1	11x30	2998
PL1 42937	Railing strip - Begrenzungsleiste - Rembarde - Sbarra - Afscheidingslijst - Piirdelaud 	2	18x70	612
PL2 44297	Railing strip - Begrenzungsleiste - Rembarde - Sbarra - Afscheidingslijst - Piirdelaud 	4	18x70	1939
PL3 35597	Railing strip - Begrenzungsleiste - Rembarde - Sbarra - Afscheidingslijst - Piirdelaud 	1	18x70	2000
PL4 42940	Railing strip - Begrenzungsleiste - Rembarde - Sbarra - Afscheidingslijst - Piirdelaud 	2	18x90	802
PL5 44212	Railing strip - Begrenzungsleiste - Rembarde - Sbarra - Afscheidingslijst - Piirdelaud 	1	18x90	3040
PL6 37903	Railing strip - Begrenzungsleiste - Rembarde - Sbarra - Afscheidingslijst - Piirdelaud 	1	18x90	3150
P1 44209	Post - Pfosten - Poteau - Piede registrabile - Stijl - Post  	1	88x88	2052
P2 44207	Post - Pfosten - Poteau - Piede registrabile - Stijl - Post  	1	88x88	2500
P3 43507	Post - Pfosten - Poteau - Piede registrabile - Stijl - Post 	3	90x90	2500
TB 2247	Fascia board - Traufbrett - Bandeau de toit - Finitura lati tetto - Gevellijst Räästalaud 	2	18x90	4300
DRV 2248	Roof edge reinforcement - Dachrandverstärkung - Corniere de renfort de bord de toit - Rinforzo x tetto - Dakrand versterking - Räästatugevdus 	2	28x34	4300
24653	Ladder - Leiter - Echelle - Scala a pioli - Ladder - Redel 	9	28x120	542
44236 44237	Ladder - Leiter - Echelle - Scala a pioli - Ladder - Redel 	2	44x120	2750
FF2 39848	Fixing fillet - Fixierungsleiste - Profil de fixation - Massello di fissaggio - Bevestiging lijstwerk - Tenderliist 	2	18x44	1900

Pos	18.04.2023 Piece list - Stückliste - Liste des pièces - Elementi - Stuklijst - Tükítabel Art. Nr. 4429719 9/23	Q	P (mm)	L (mm)
FF3 44388	Fixing fillet - Fixierungsleiste - Profil de fixation - Massello di fissaggio - Bevestiging lijstwerk - Tenderliist 	2	18x44	2000
FF4 38464	Covering moulding - Deckungsprofil - Profils de finition verticaux a fixer a l'exterieur du cadre de la porte - Cornice di finitura - Afdek profiel - Lengipuu 	1	38x46	2998
GL 42375	Gable moulding - Giebelleiste - Planche de rive - Finitura per frontale e retro del tetto - Gevellijst - Viilulaud 	4	18x120	2200
HS8 5105	Screw for gable segment - Schrauben für deckblatt - Vis pour fixation losange de finition - Viti x frontali tetto - Schroef voor gevelpunt segment - Kruvi rombile 	4	3.5x35	
HS9 5106	Screw for gable moulding - Schrauben für giebelleiste - Vis pour fixation planche de rive - Vite per fissare finiture davanti e dietro del tetto - Schroef voor gevellijst - Kruvi viilulauale 	32	3.5x50	
HS32 5107	Screw for door jamb - Schraube für türrahmen - Vis de fixation partie haute avec montants du cadre de porte - Viti x fissaggio montanti porte - Schroef voor deurkozijn - Kruvi ukse lengile 	10	4.5x25	
HS14 5111	Screw for stairs - Schraube für treppen - Vis pour escalier - Vite per le scale - Schroef voor trap - Kruvi trepile 	36	4.5x80	
HS12 5109	Screw for covering moulding - Schrauben für deckungsprofil - Vis de fixation profils horizontaux haut inférieur et extérieur d'encadrement de porte - Vite per cornice di copertura - Schroef voor afdekprofiel - Kruvi piirdelauale 	80	4x40	
HS12 5109	Screw for universal hook - Schrauben für universalhaken - Vis pour crochets universels - Vite per gancio universale - Schroef voor universele haak - Kruvi redeli fiksaatorile 	4	4x40	
HS12 5109	Screw for fascia boards - Schrauben für traufbretter - Vis pour fixation bandeau de toit - Viti x striscia del tetto - Schroef voor gevellijst - Kruvi räästalauale 	20	4x40	
HS12 5109	Screw for roof edge reinforcement - Schrauben für dachrandverstärkung - Vis pour fixation corniere renfort de bord de toit - Viti x rinforzo bordo tetto - Schroef voor dakrand versterking - Kruvi räästatugevdusele 	20	4x40	
HS12 5109	Screw for fixing fillet of door and window - Schrauben für fixierungsteiste - Vis pour profil vertical de fixation pour ouvertures des fenetres et portes - Viti per massello di fissaggio - Schroeven voor bevestiging van deur en raam lijsten - Kruvi tenderliistudele 	34	4x40	
HS12 5109	Screw for door jamb - Schraube für türrahmen - Vis de fixation partie haute avec montants du cadre de porte - Viti x fissaggio montanti porte - Schroef voor deurkozijn - Kruvi ukse lengile 	10	4x40	
HS18 5113	Screw for roof beams - Schrauben für dachbalken - Vis pour fixation pannes de toit - Viti per perline del tetto - Schroef voor gordingen / dakbalken - Kruvi pärlinitete 	10	5x120	
HS18 5113	Screw for beam - Schrauben zur befestigung dachsparren - Vis pour solive (s) - Viti per pertine - Schroef voor balk (gording) - Kruvi talale 	10	5x120	
HS18 5113	Screw for gable - Schrauben für giebel - Vis pour fixation des pignons - Viti per timpano - Schroef voor gevelpunt - Kruvi viilude kinnitamiseks 	4	5x120	
HS33 5112	Screw for door jamb - Schraube für türrahmen - Vis de fixation partie haute avec montants du cadre de porte - Viti x fissaggio montanti porte - Schroef voor deurkozijn - Kruvi ukse lengile 	12	5x40	
HS34 40958	Screw for wall details - Schraube für wand details - Vis pour mur details - Viti per elementi della porta - Schroef voor wand details - Kruvi seinte montaaziks 	360	5x80	
HS16 5115	Screw for 1. wall beam - Schraube für 1. bohlenreihe - Vis de fixations 1ere rangée de madriers avec poutrelles de fondations - Vite fissaggio alle fondamenta - Schroef voor 1 wandbalk - Kruvi poollauale 	6	5x90	
HS16 5115	Screw for window jamb - Schraube für fensterrahmen - Vis de fixation pour montant de fenetre - Viti per finestra ad oblo - Schroef voor vensterbank - Kruvi akna lengile 	4	5x90	
HS16 5115	Screw for foundation - Schrauben zur befestigung fundament - Vis de fixations des poutrelles de fondations - Viti x fondamenta - Schroef voor fundering - Kruvi alusraamile 	32	5x90	
HS16 5115	Screw for door jamb - Schraube für türrahmen - Vis de fixation partie haute avec montants du cadre de porte - Viti x fissaggio montanti porte - Schroef voor deurkozijn - Kruvi ukse lengile 	6	5x90	
GS 32614	Gable segment - Deckblatt - Losange de finition - Decorazione in legno x frontale tetto - Gevelpunt segment - Romb 	2		

Art. Nr. 4429719

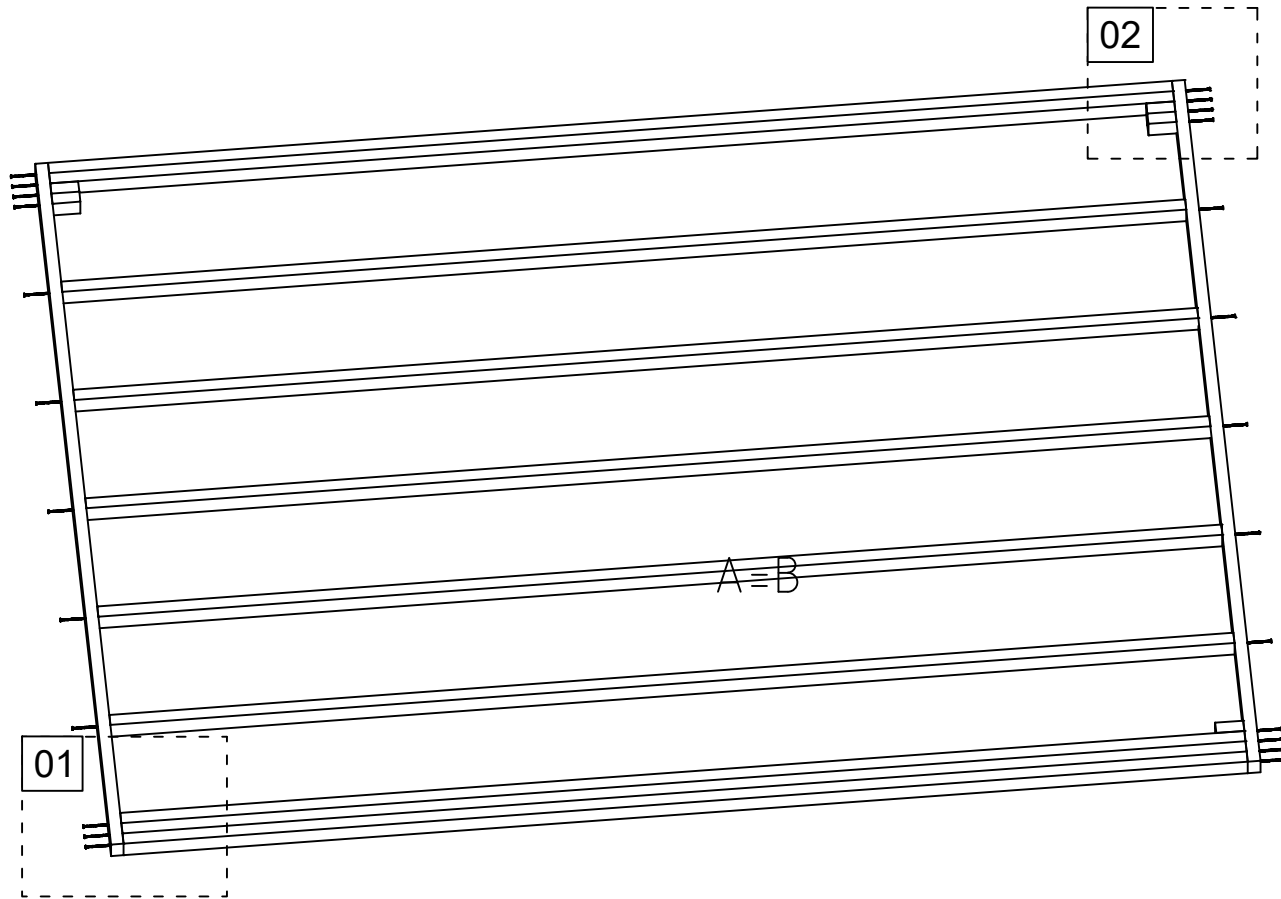

18.04.2023

01

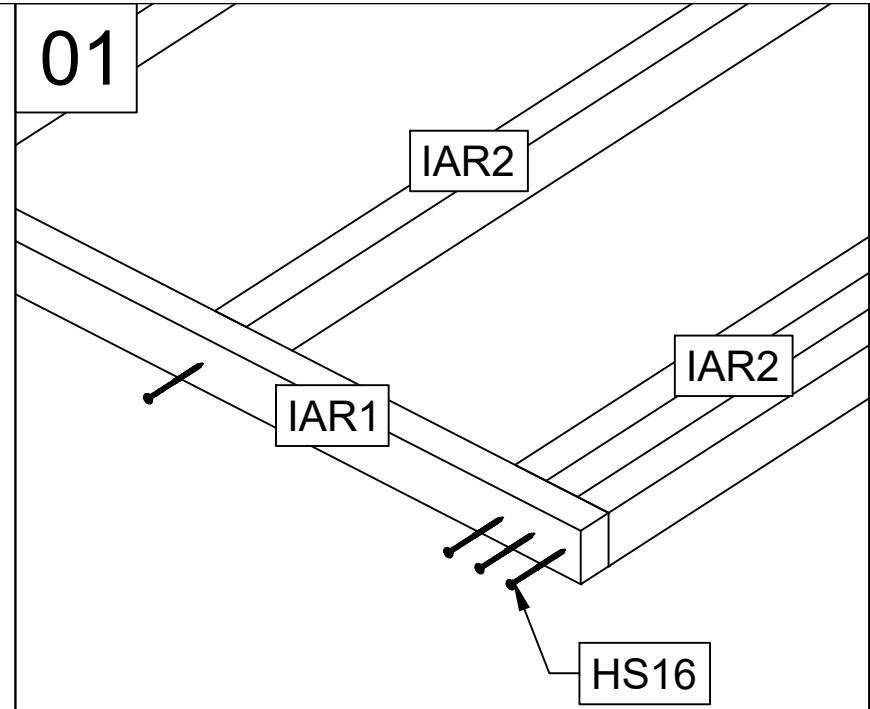

02

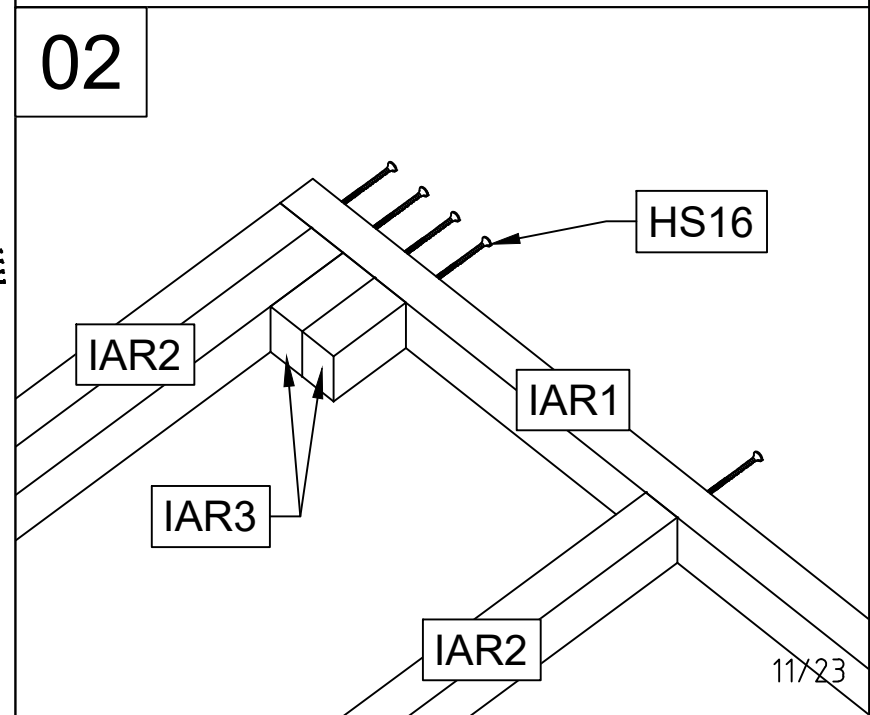

11/23

Art. Nr. 4429719

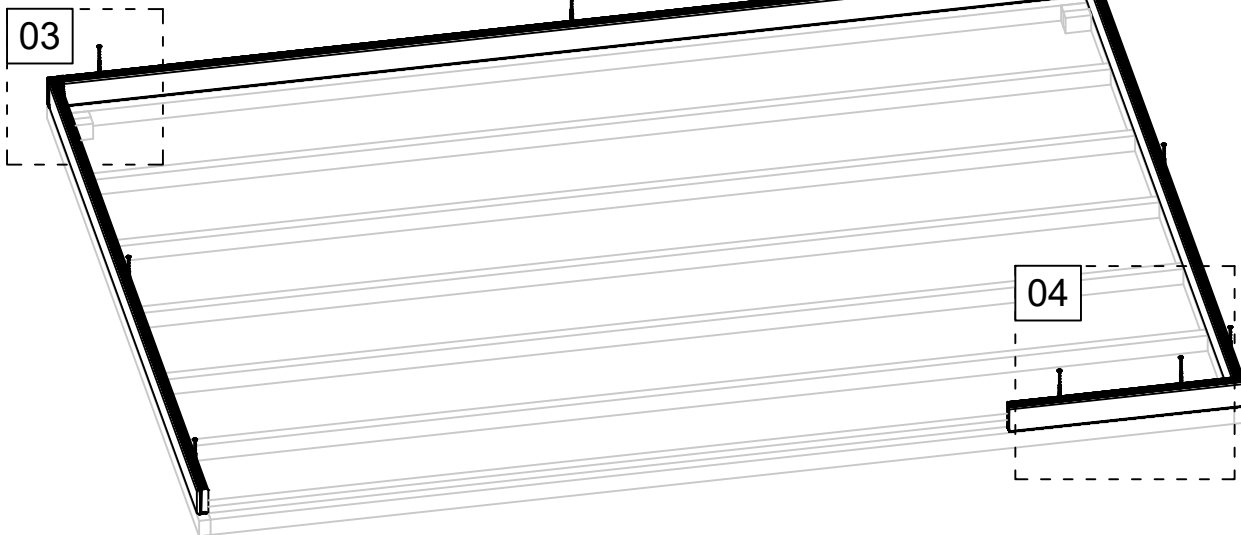

03

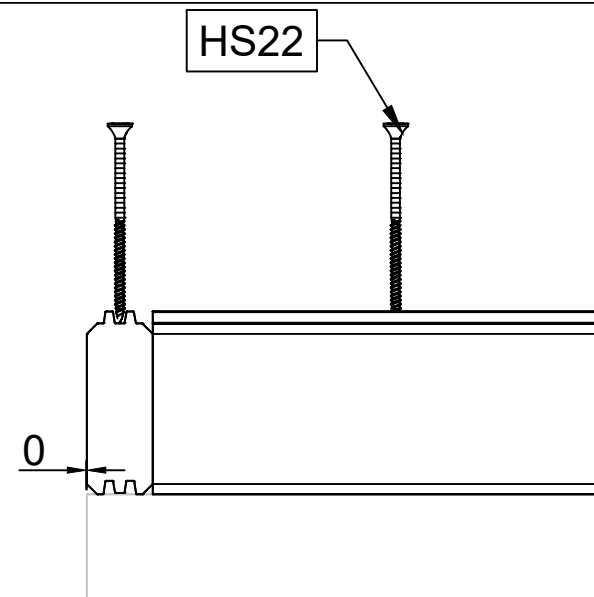

04

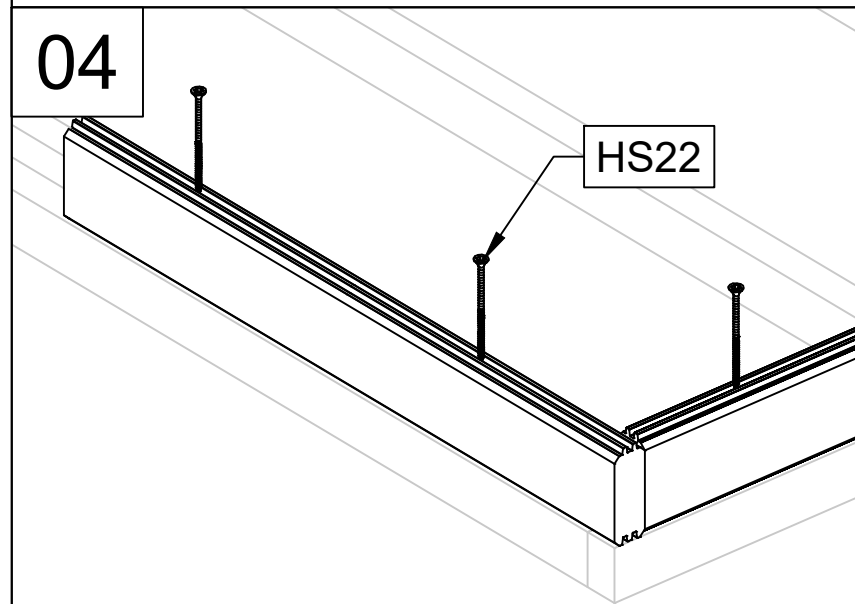

Art. Nr. 4429719

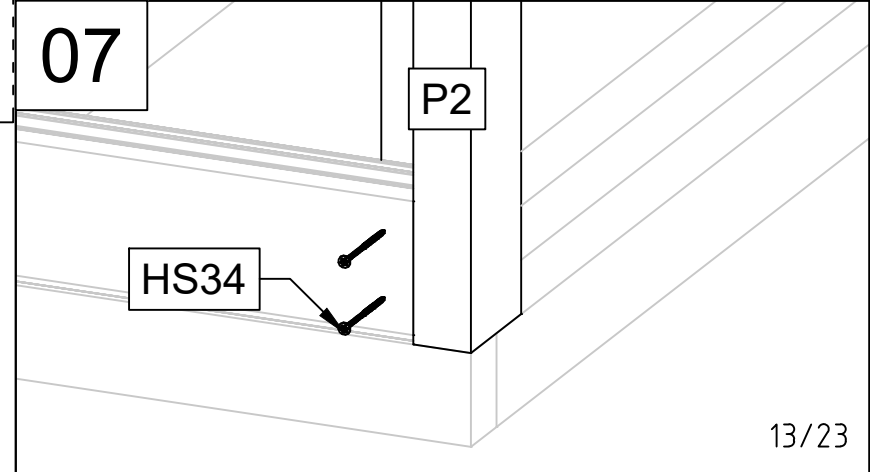
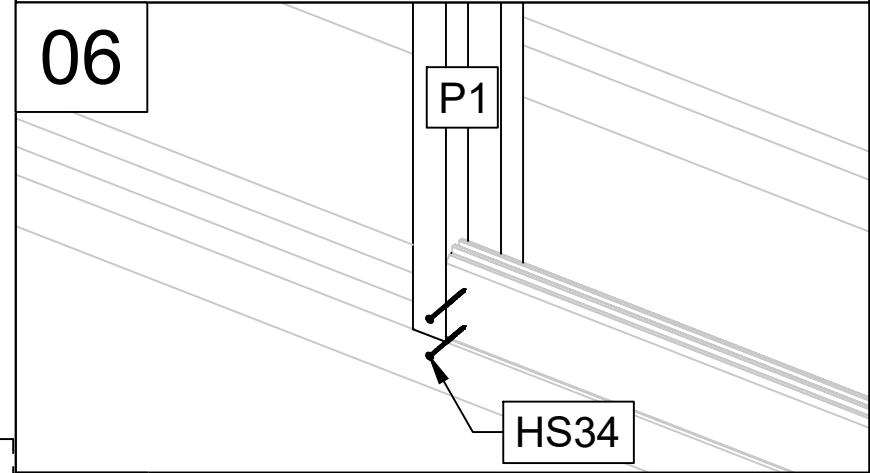
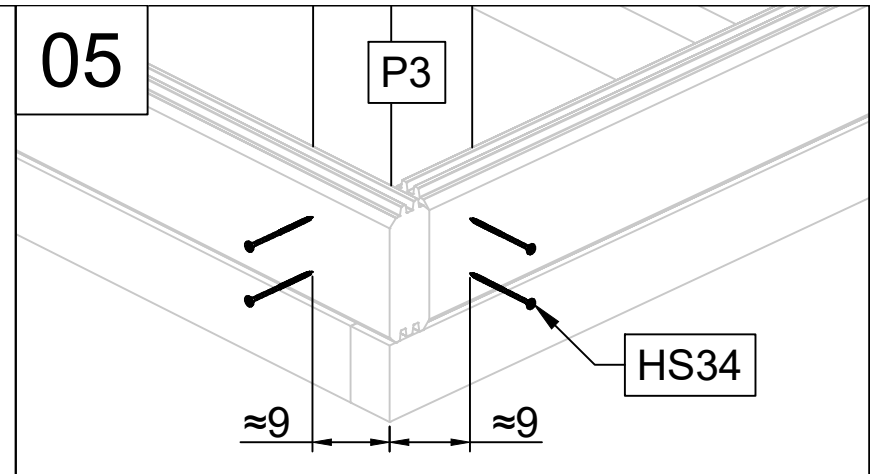
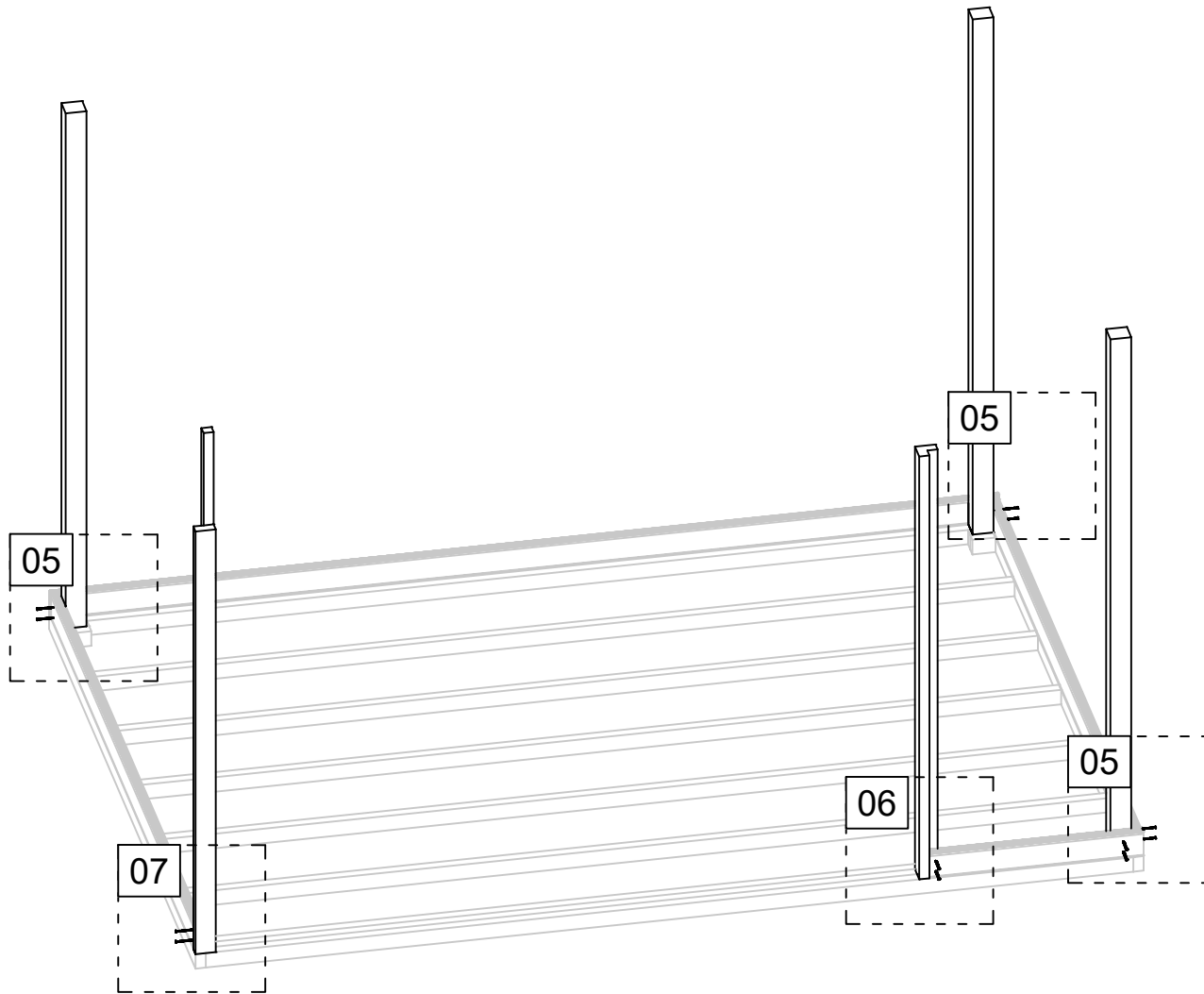

Art. Nr. 4429719

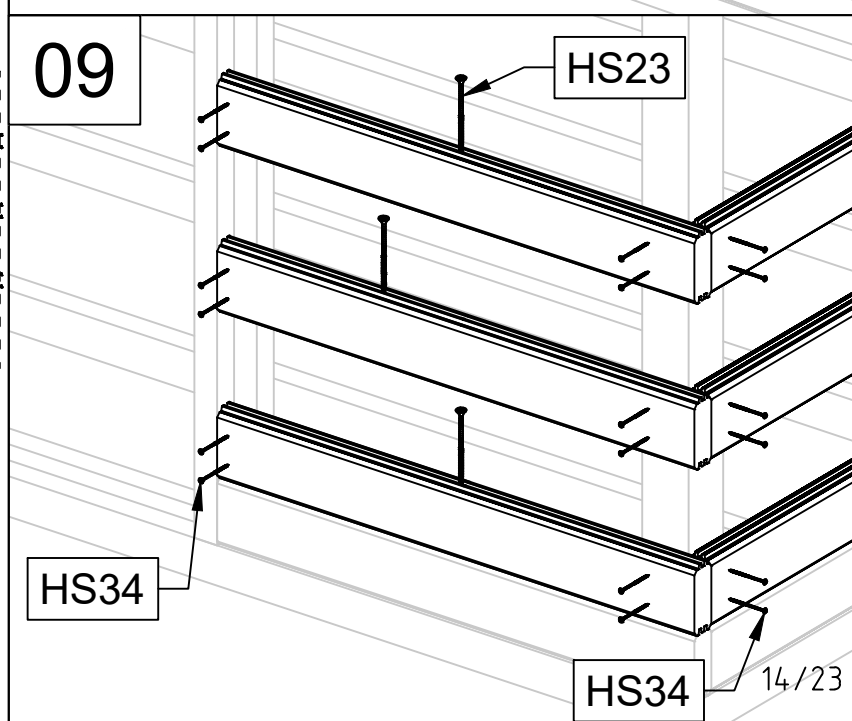
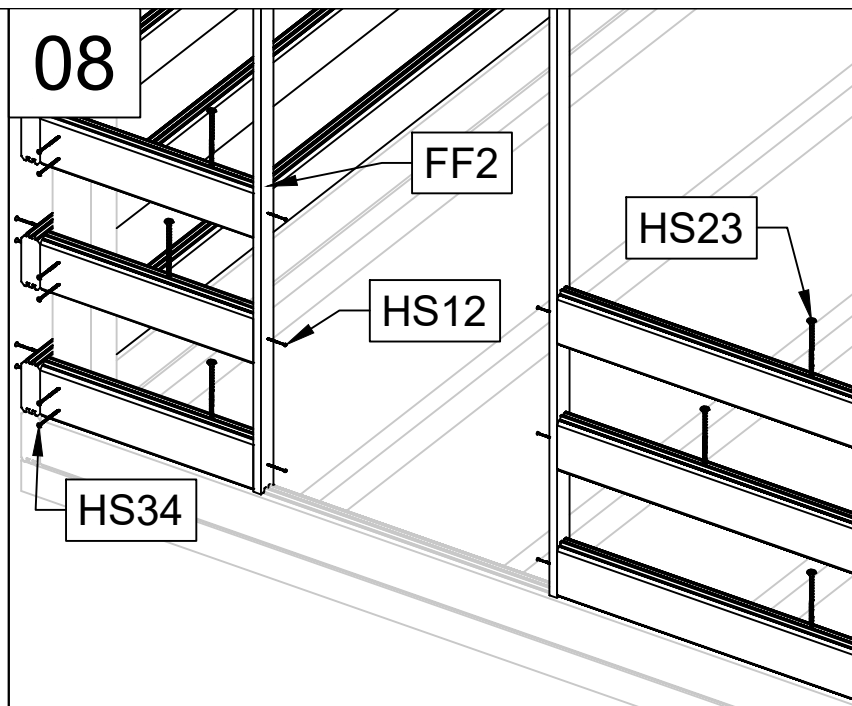
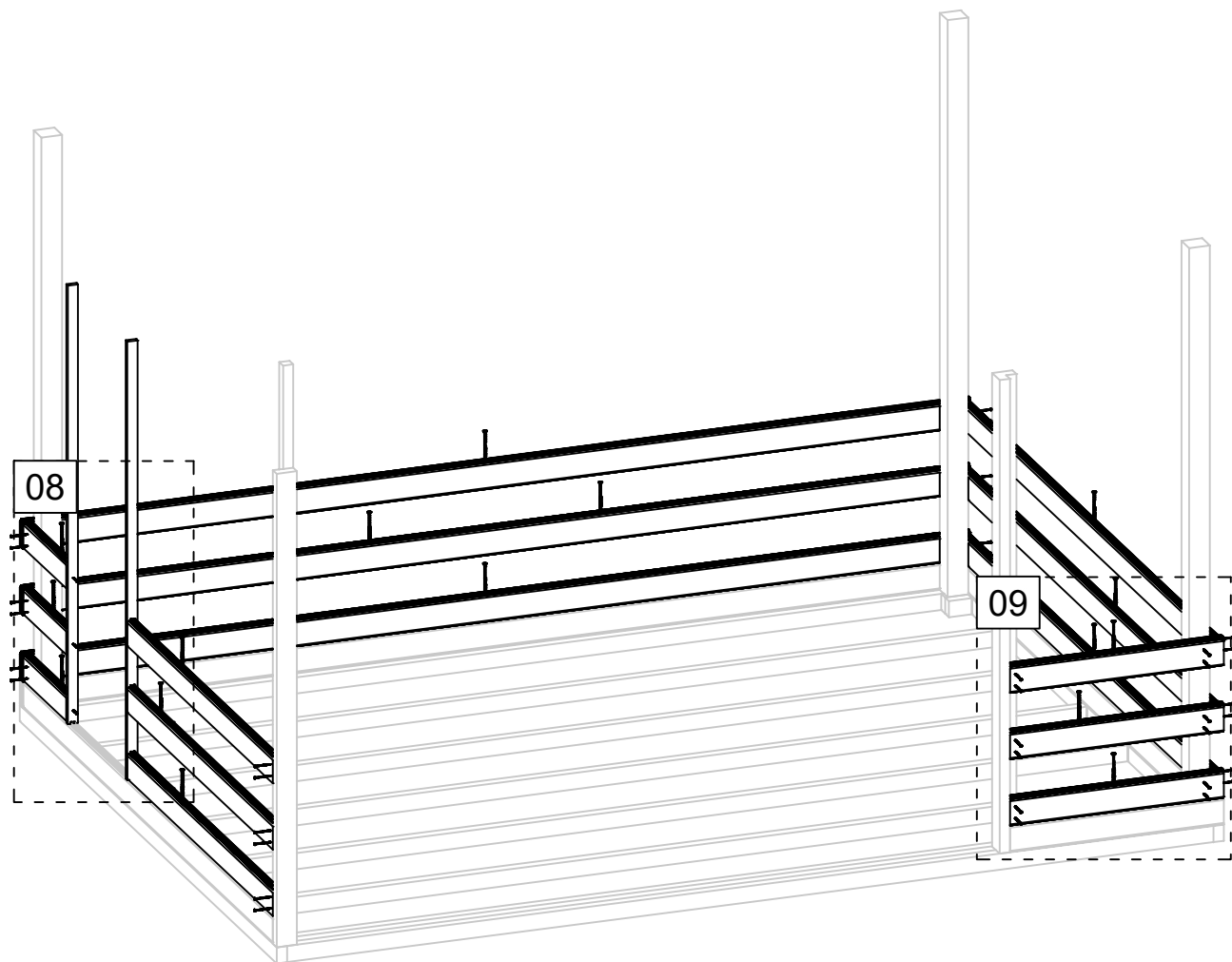

Art. Nr. 4429719

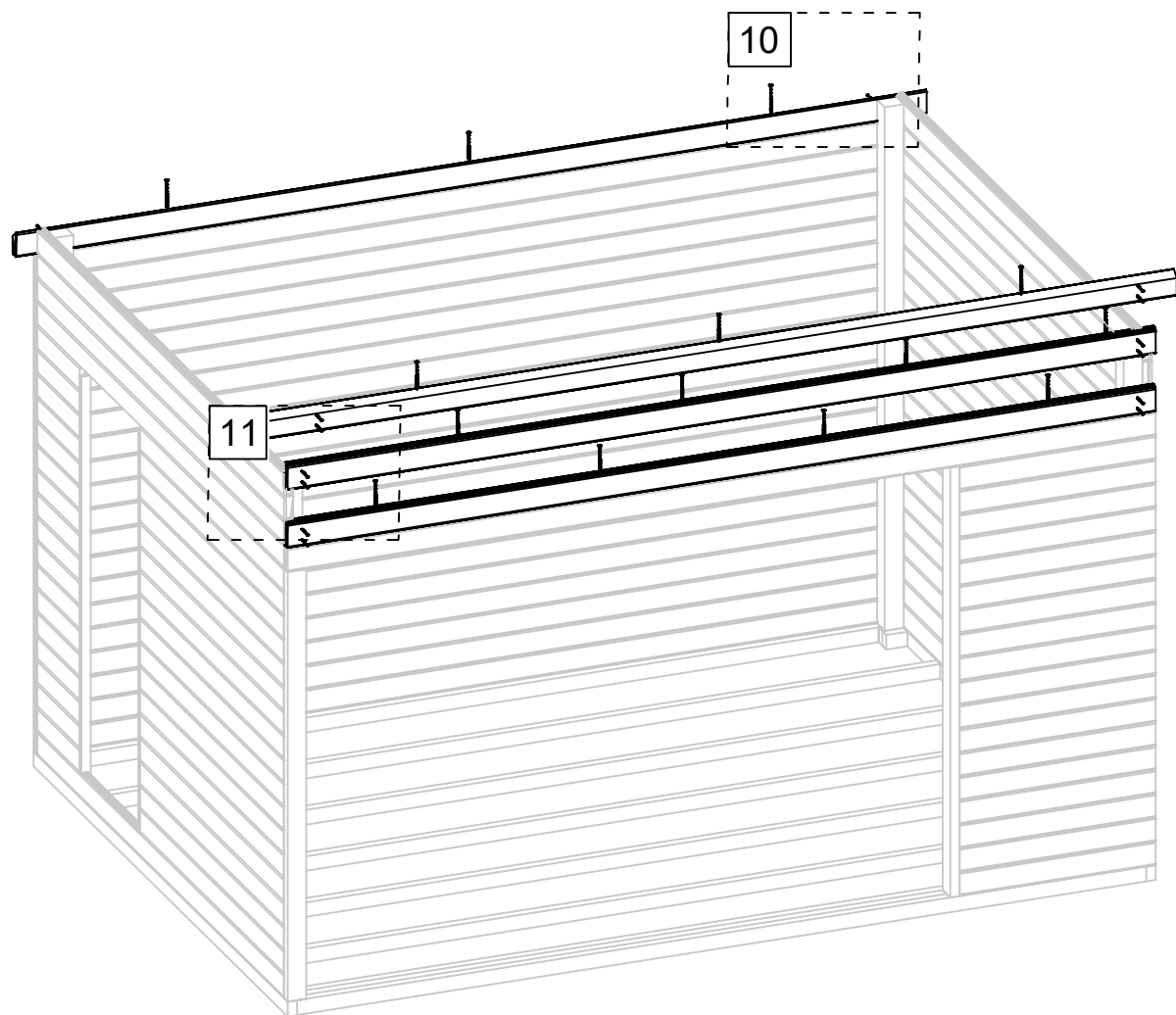

10

HS23

HS34

11

HS23

HS34

18.04.2023

15/23

Art. Nr. 4429719

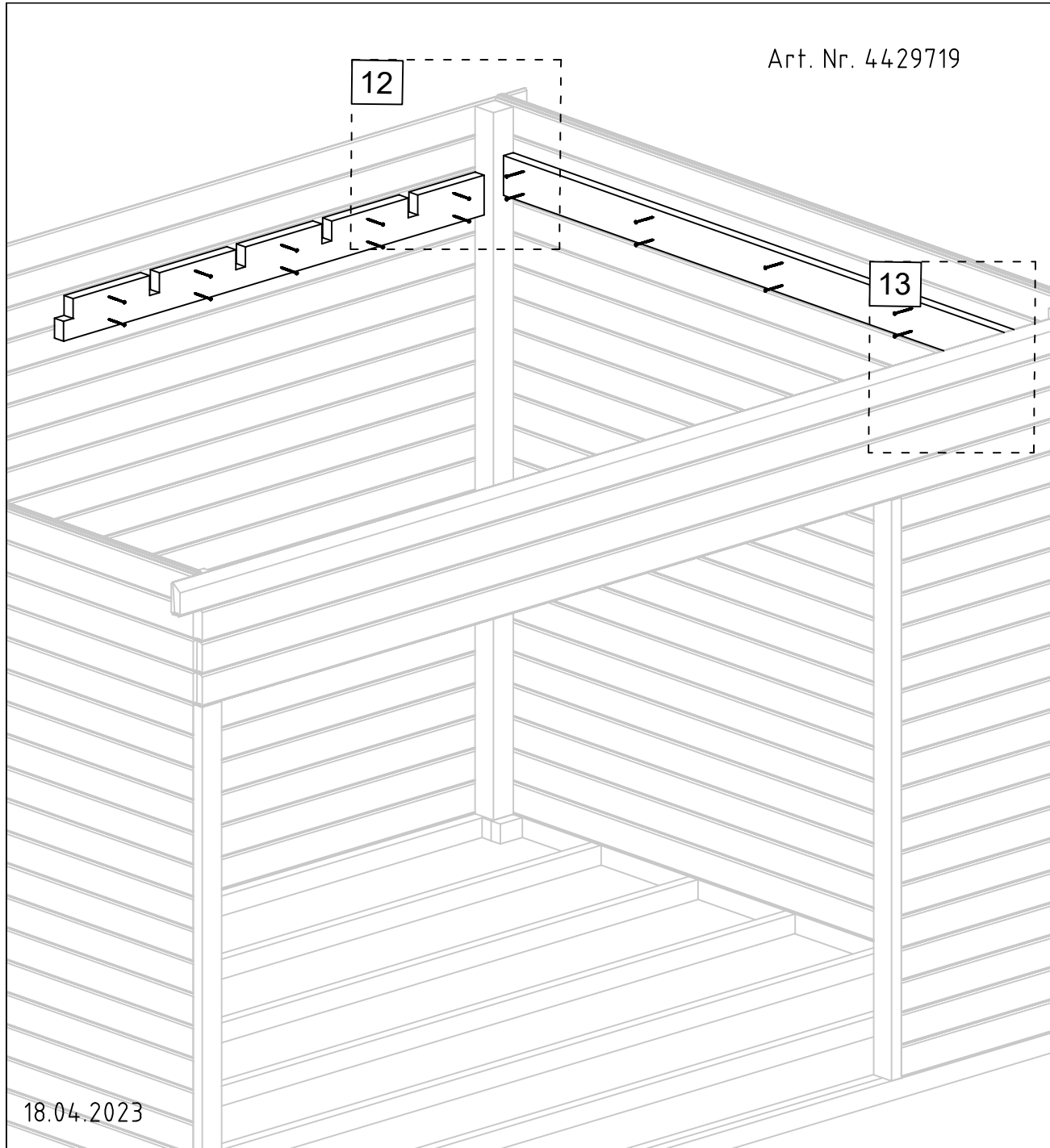

12

VT4

VT3

HS21

2127 mm

2197 mm

13

VT4

VT3

HS21

Art. Nr. 4429719

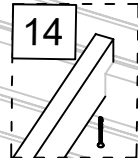
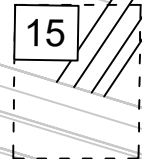

14

VT1



HS18

15

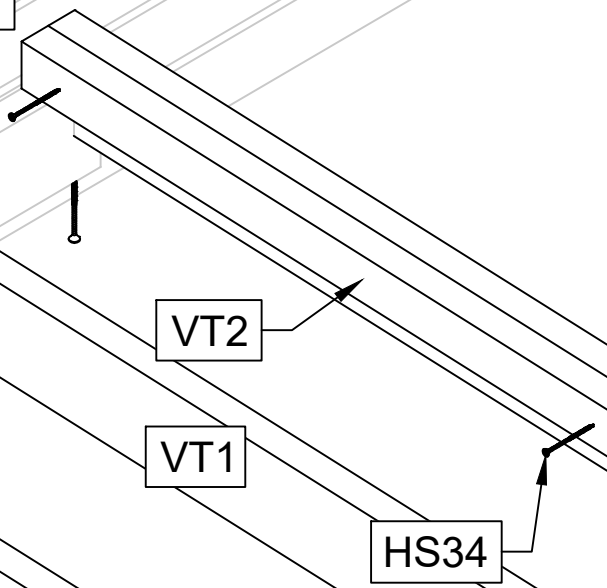

VT2

VT1

HS34

Art. Nr. 4429719

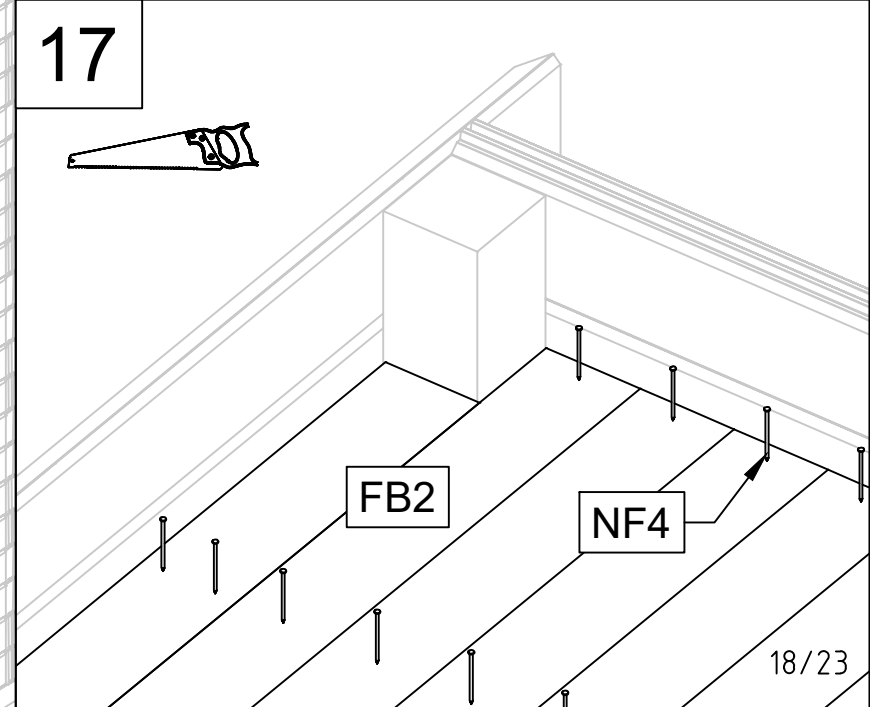
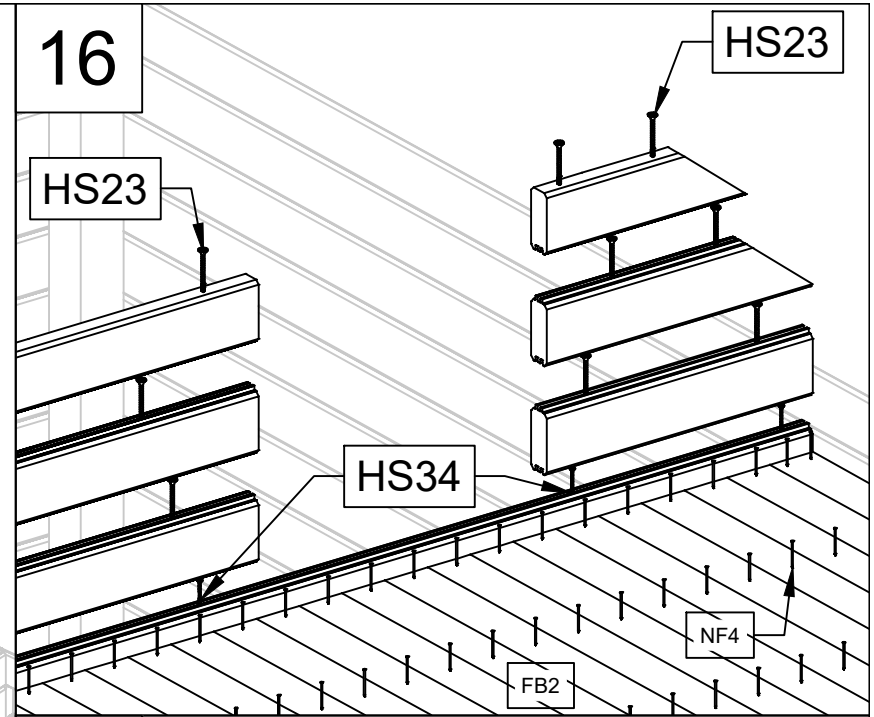
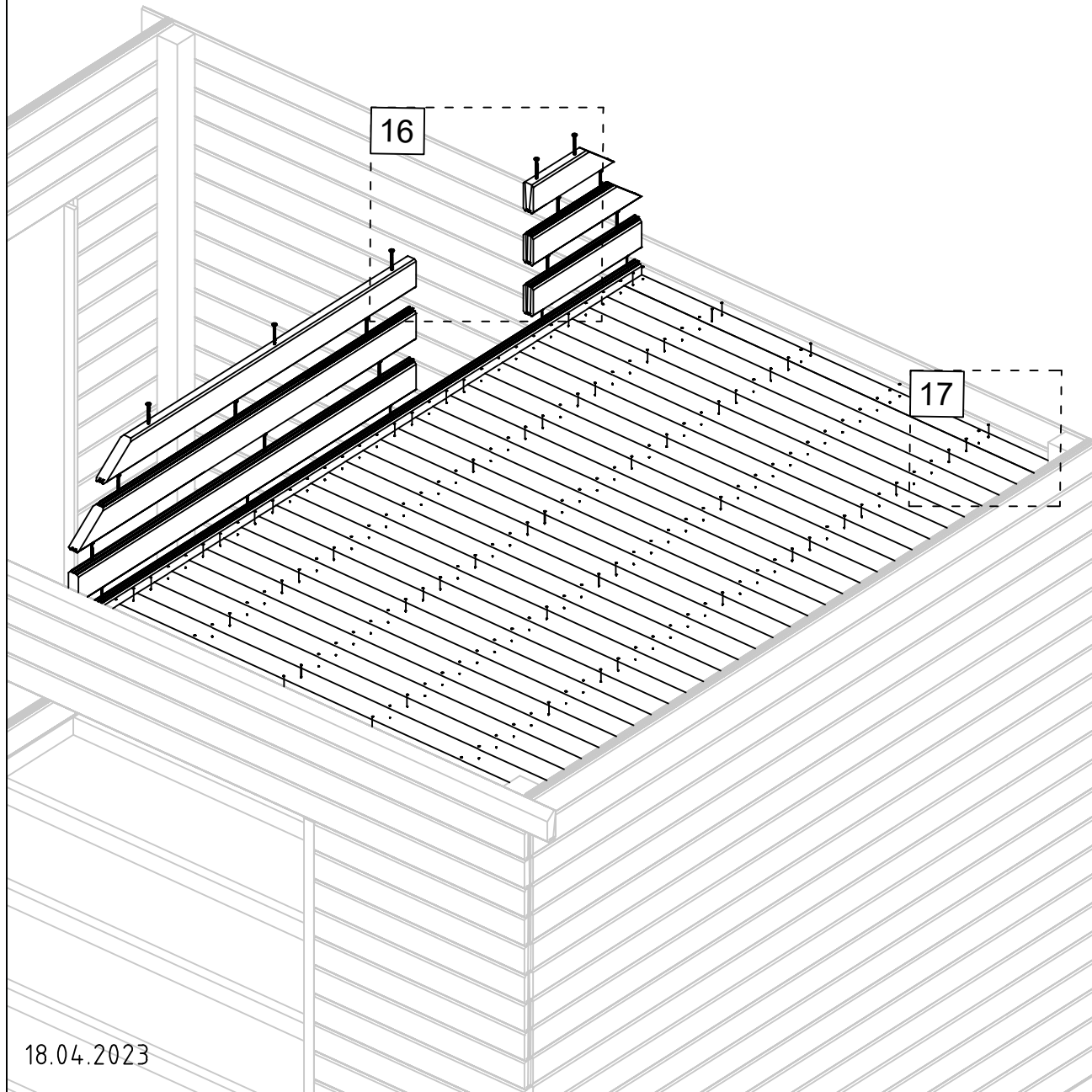

Art. Nr. 4429719

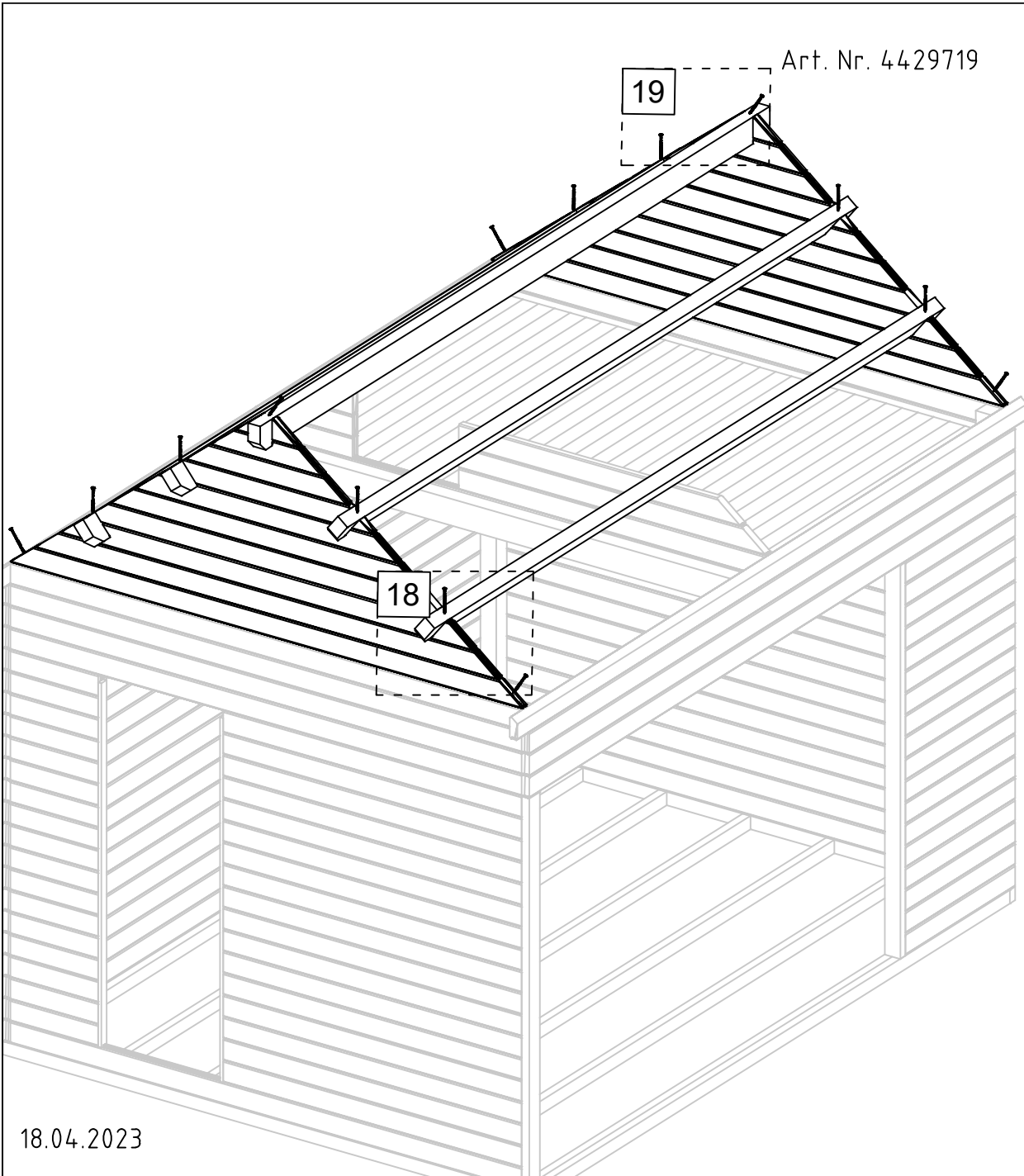

18.04.2023

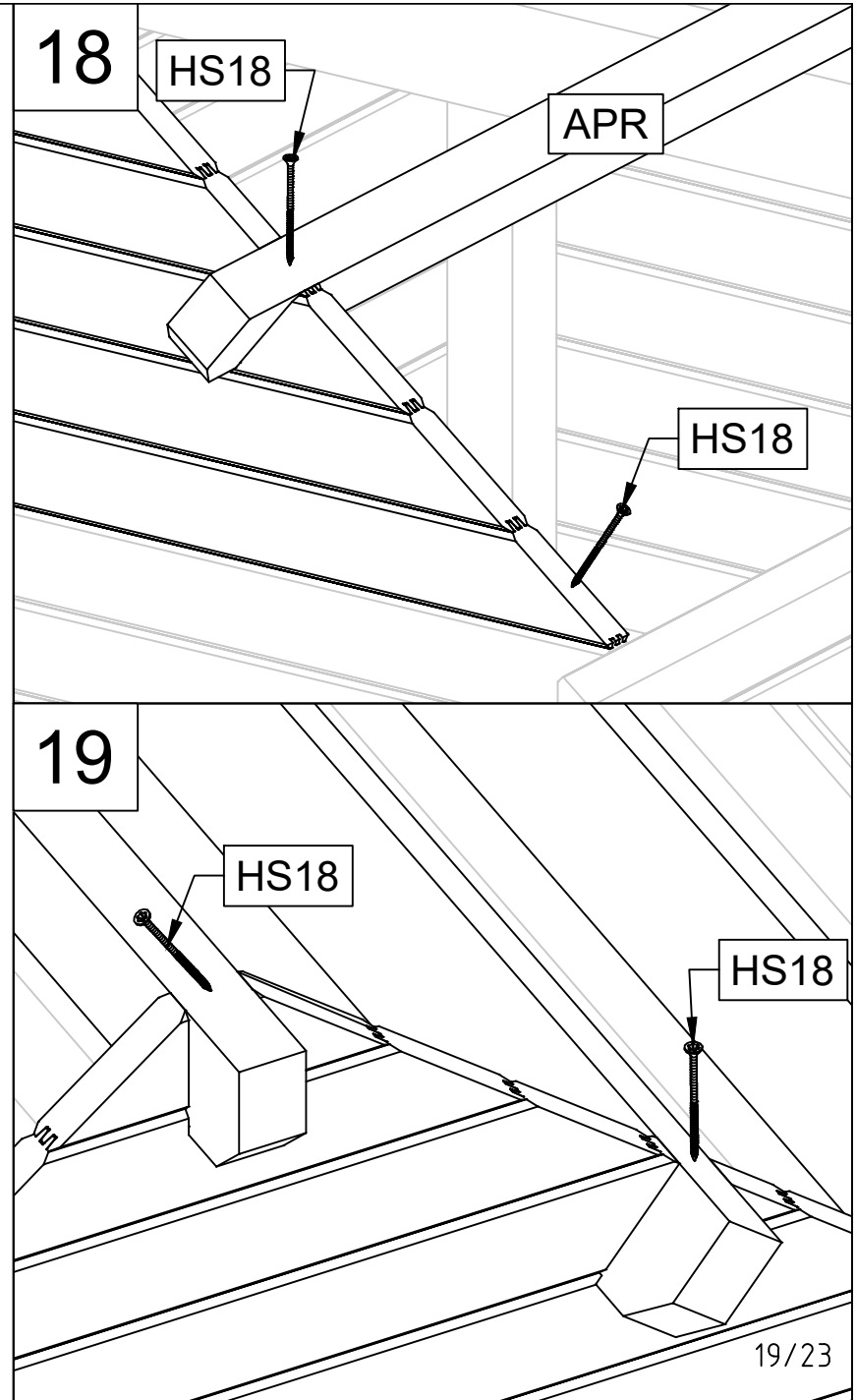

19/23

Art. Nr. 4429719

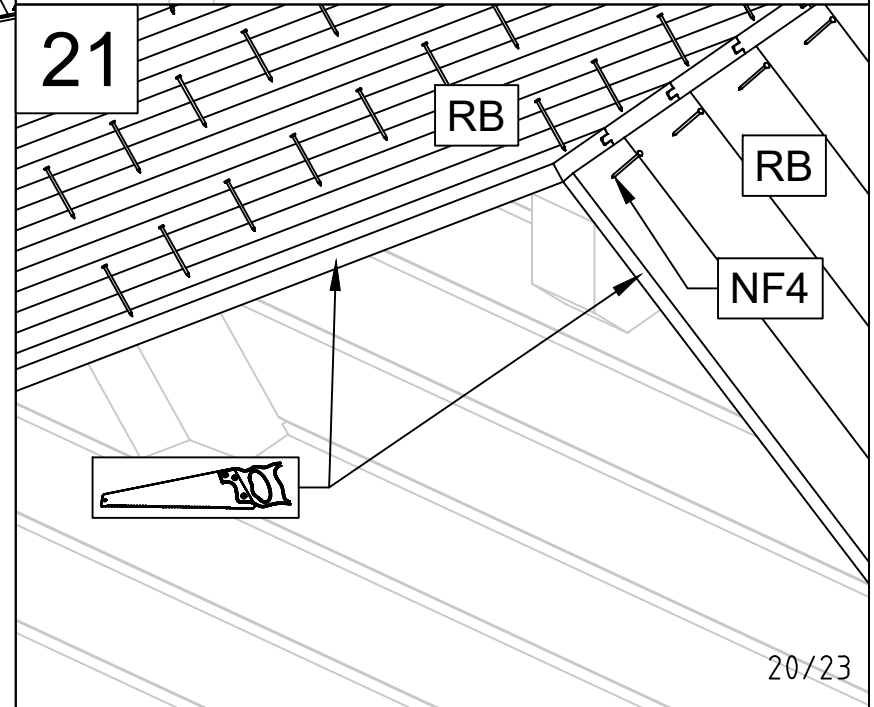
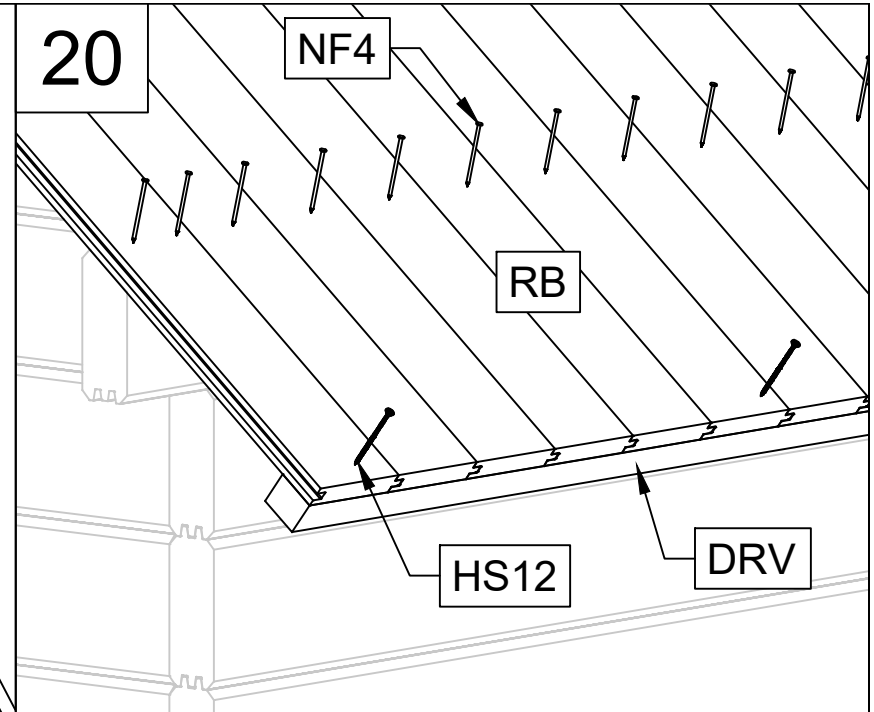
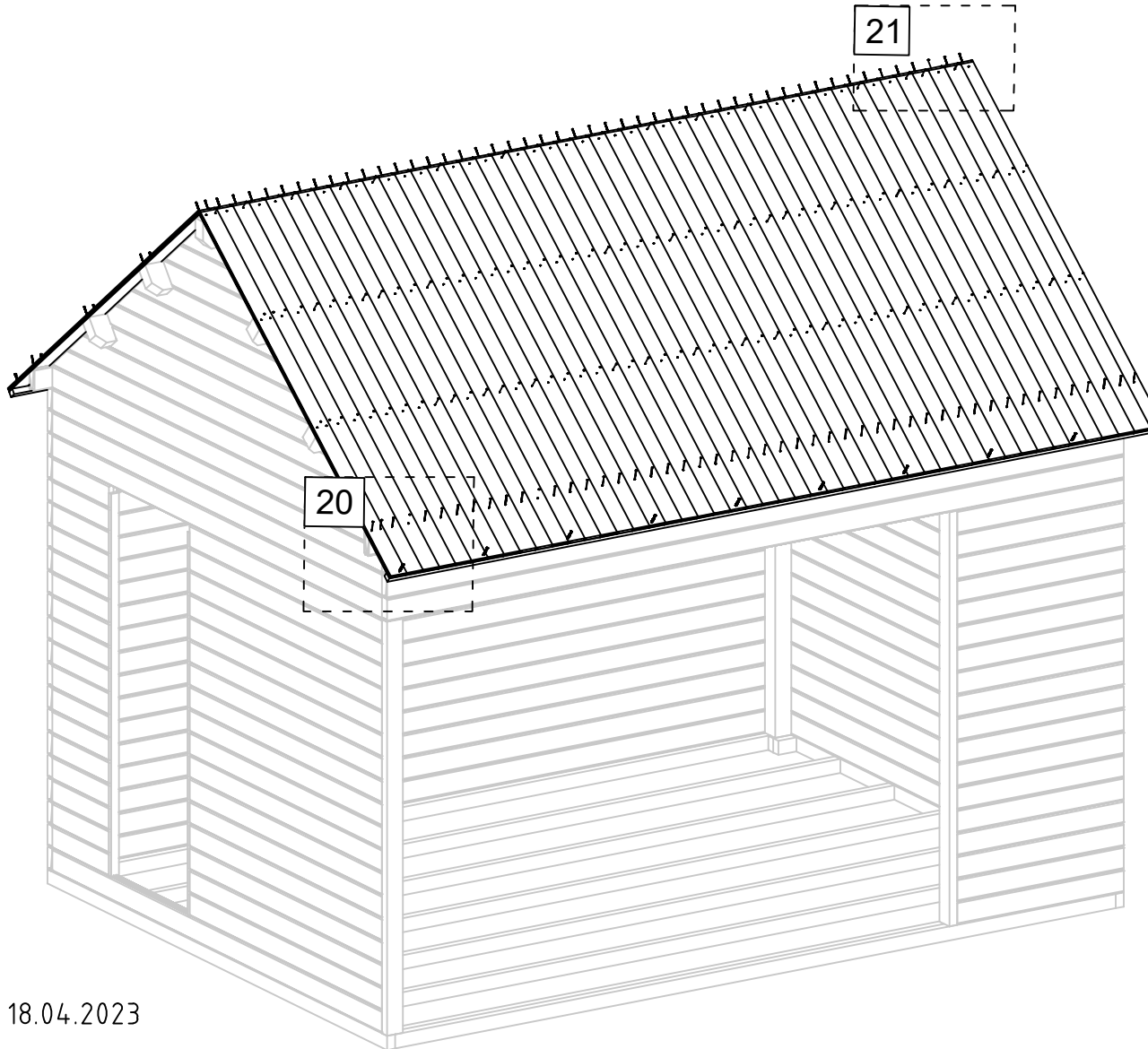

Art. Nr. 4429719

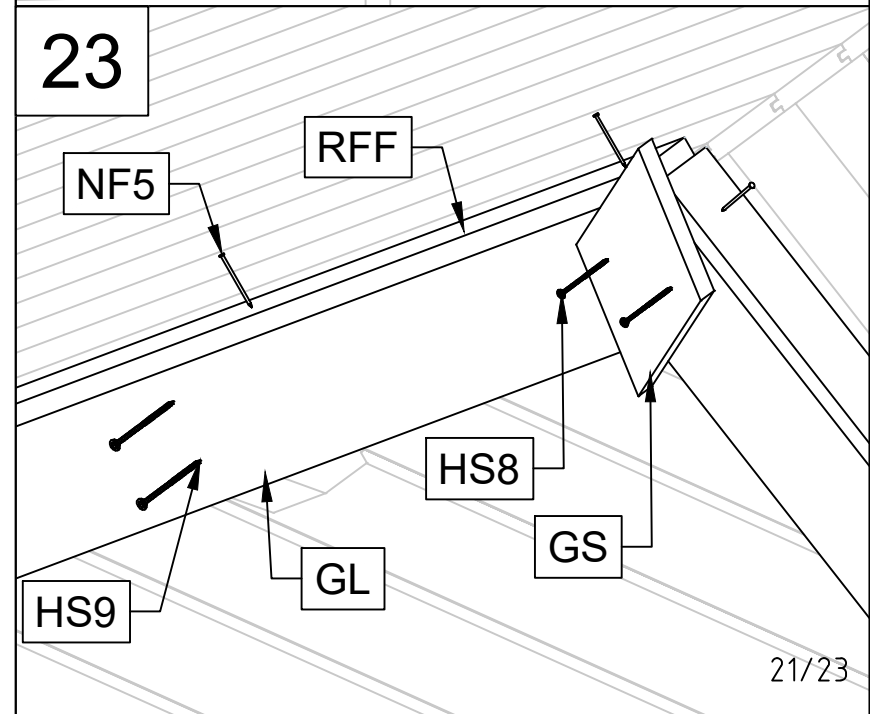
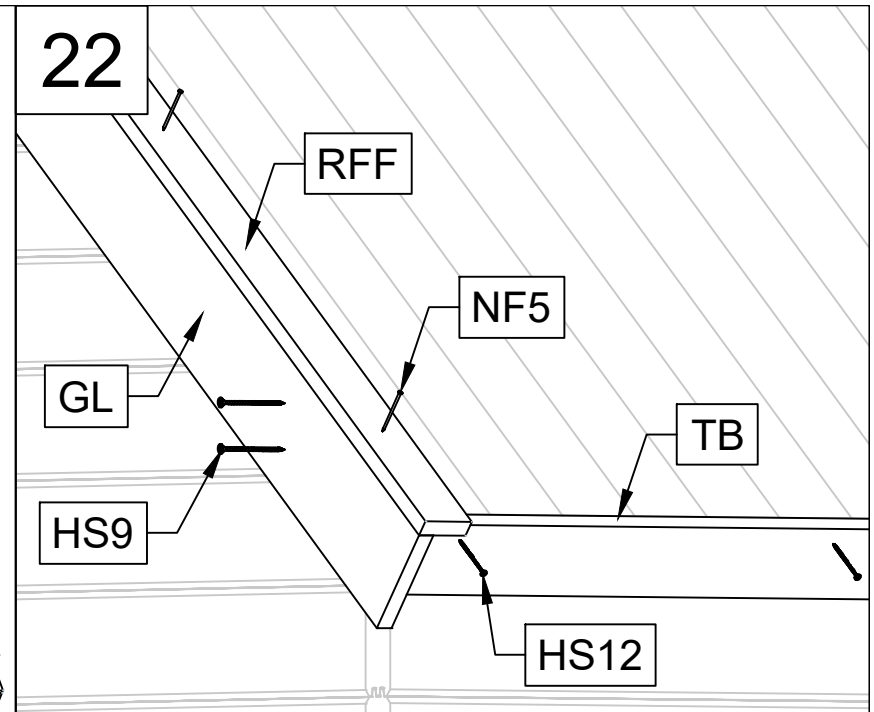
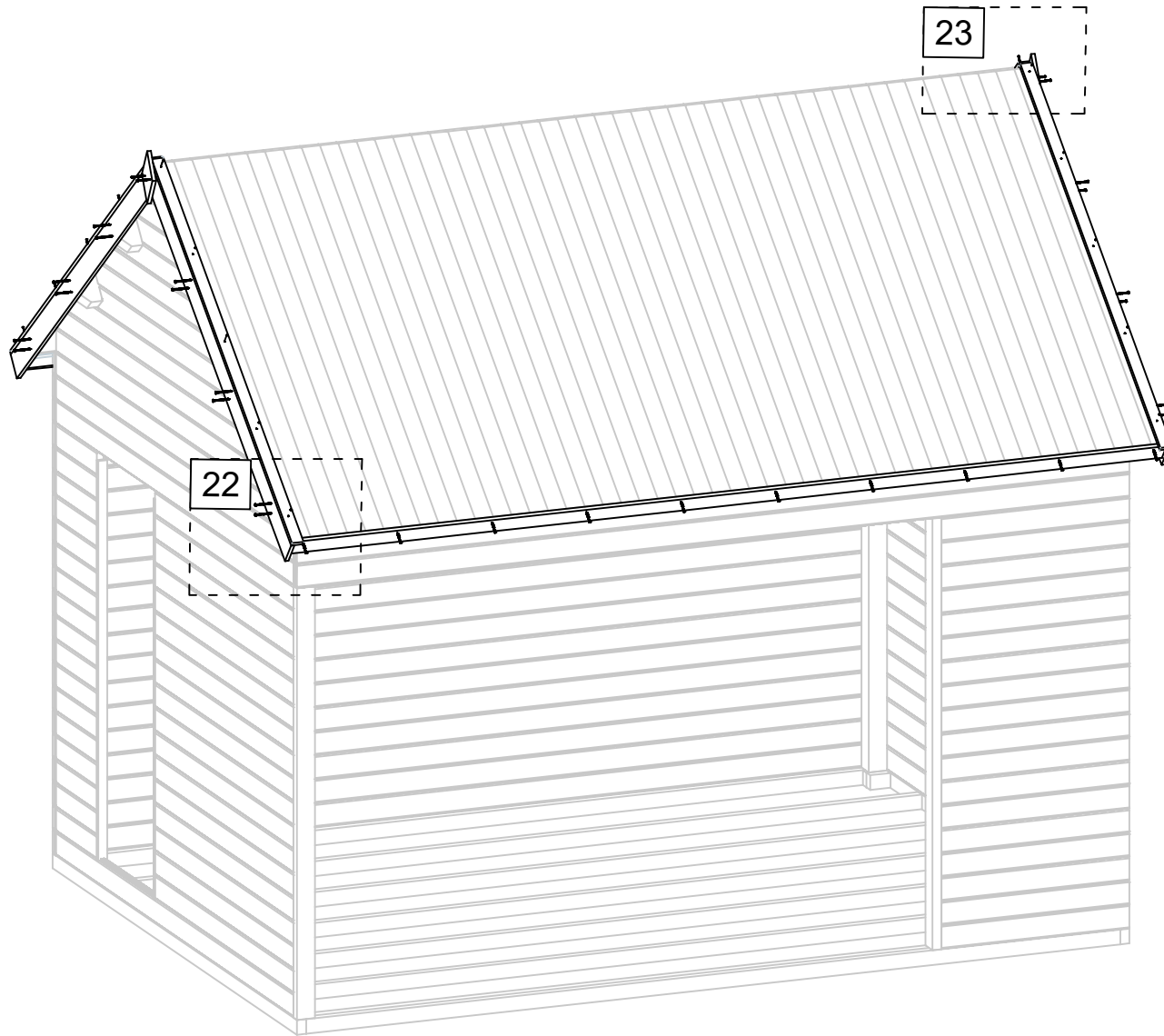

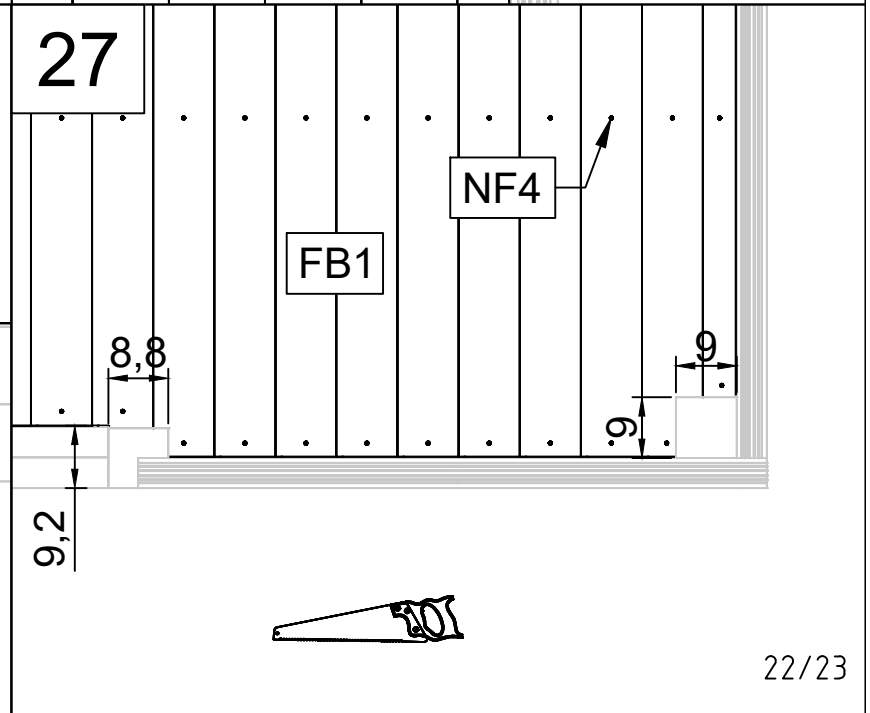
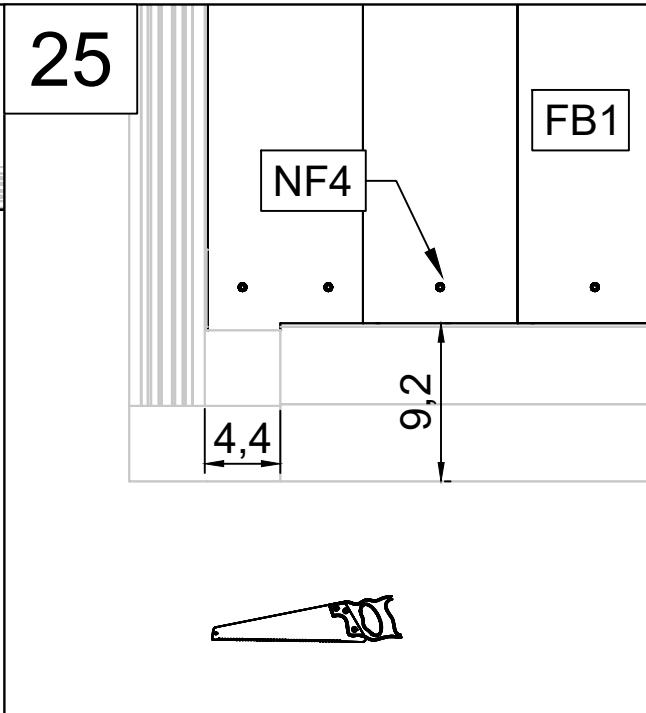
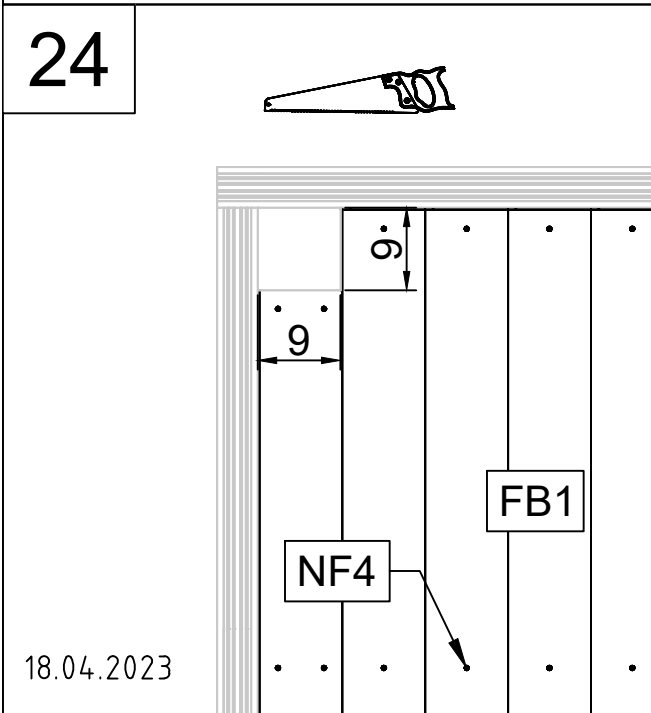
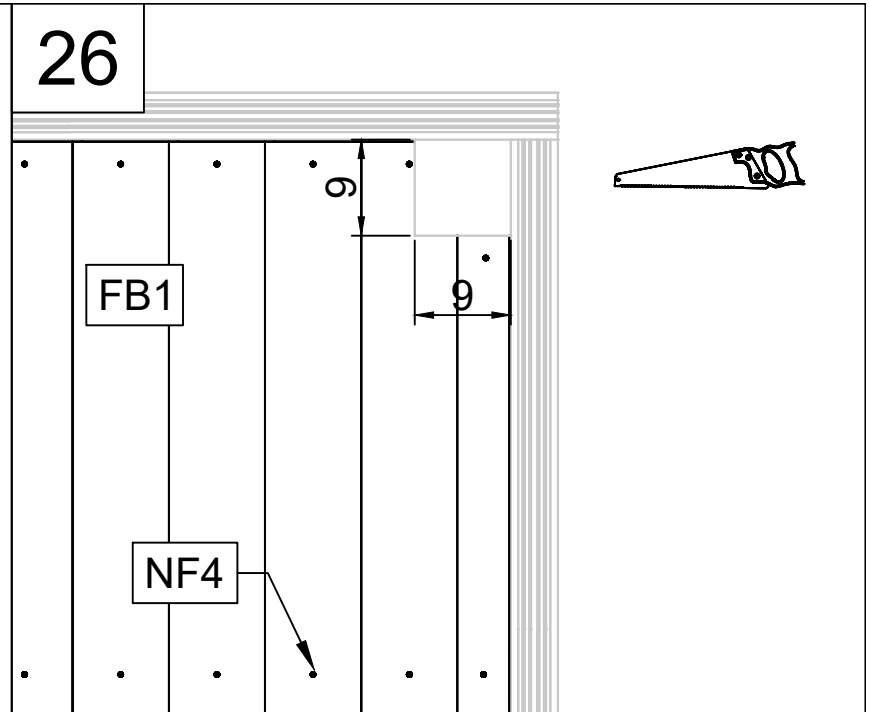
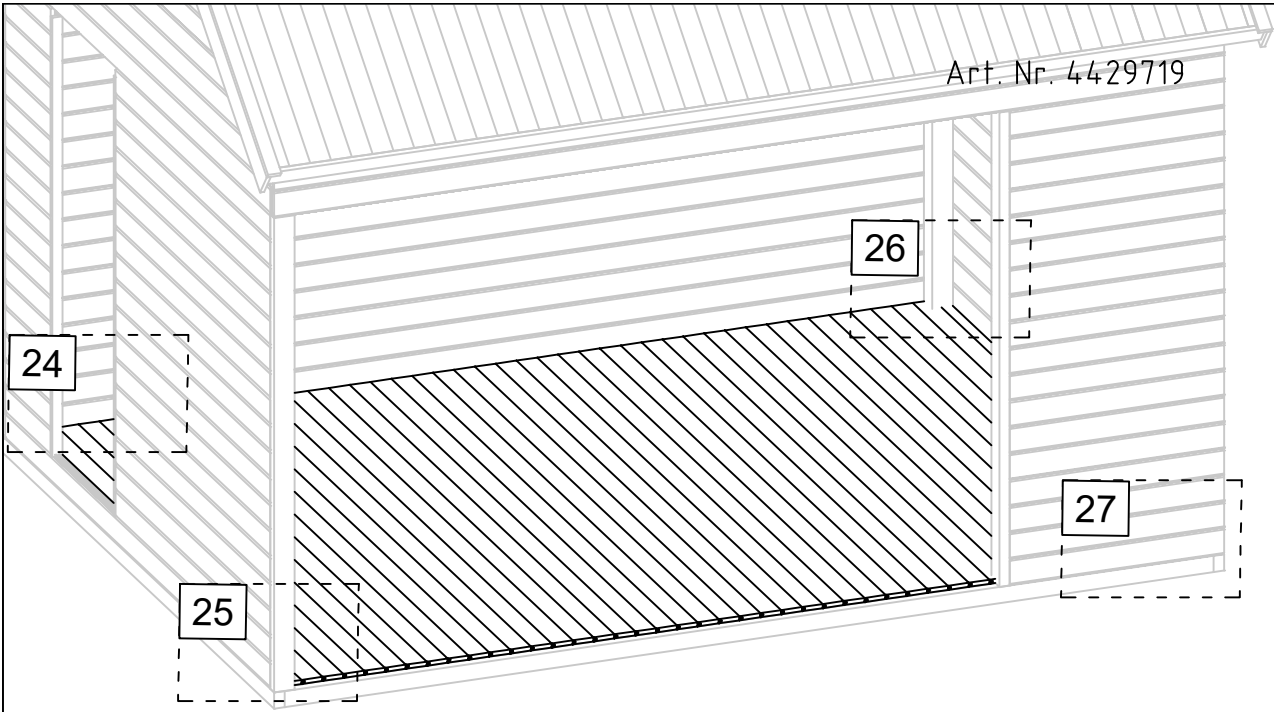

Art. Nr. 4429719

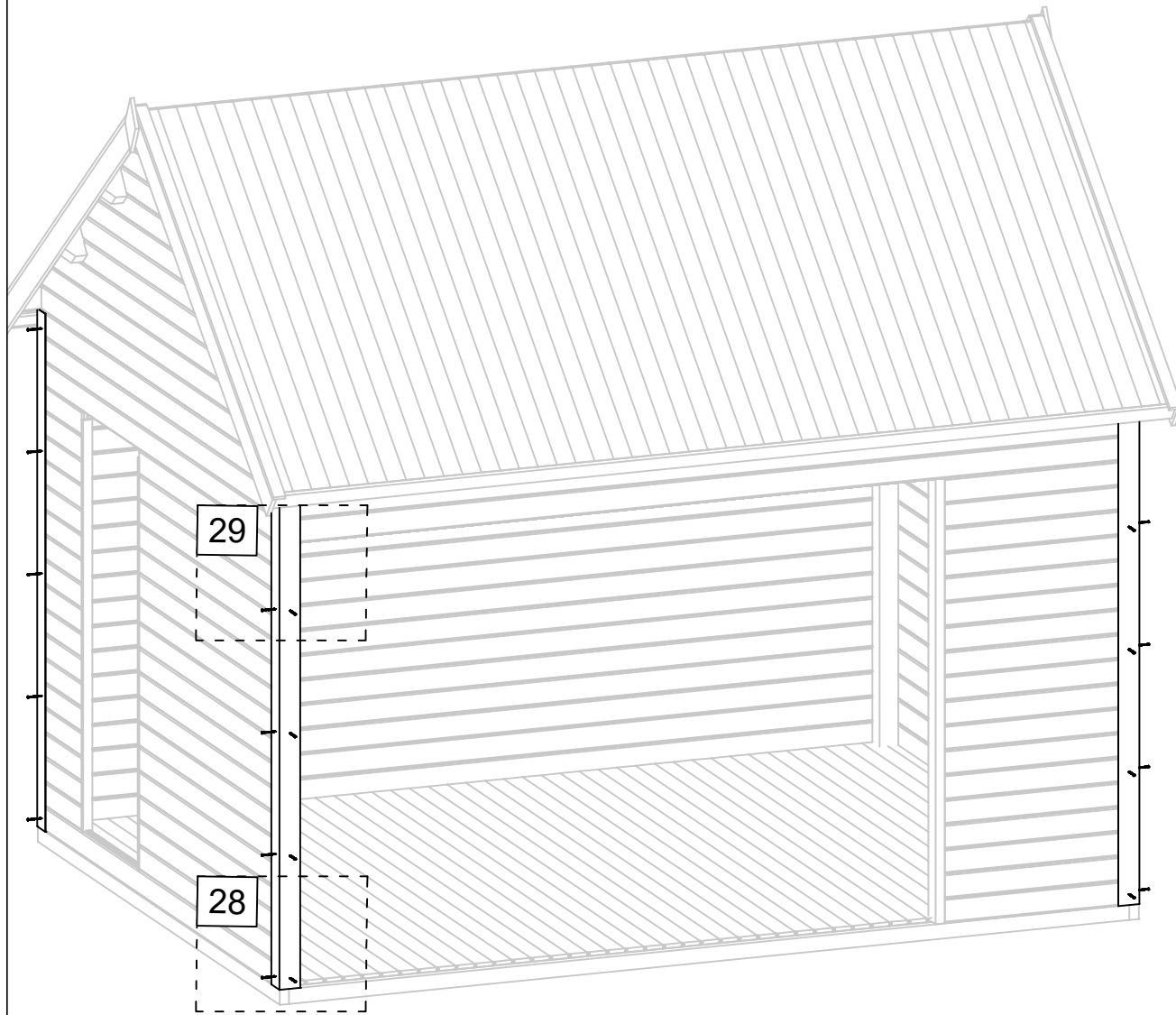

28

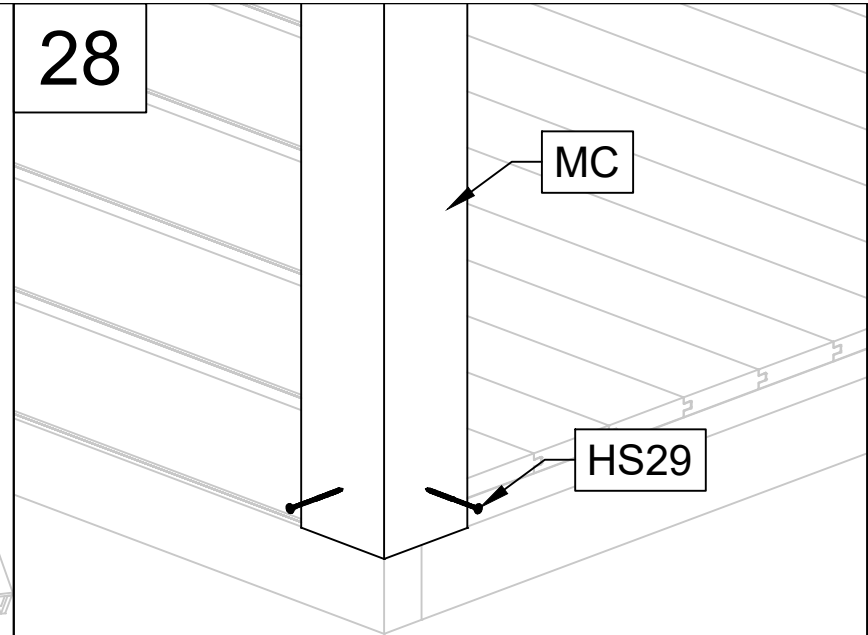

29

