

Sardinia 2
Art. Nr. 4429519
1/23

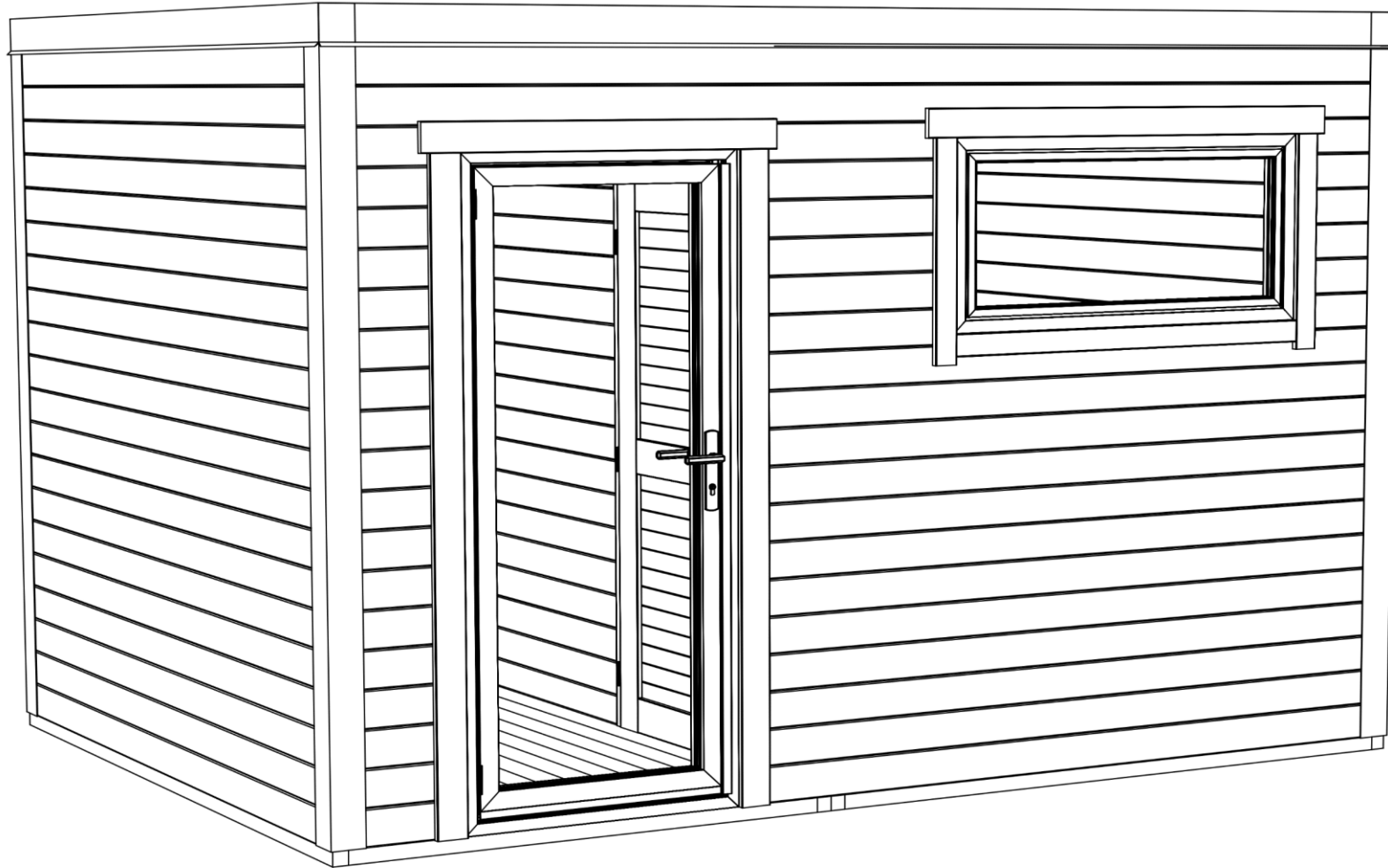

Groundplan - Grundplan - Plan de masse -
 Planimetria - Plattegrond - Põhiplaan

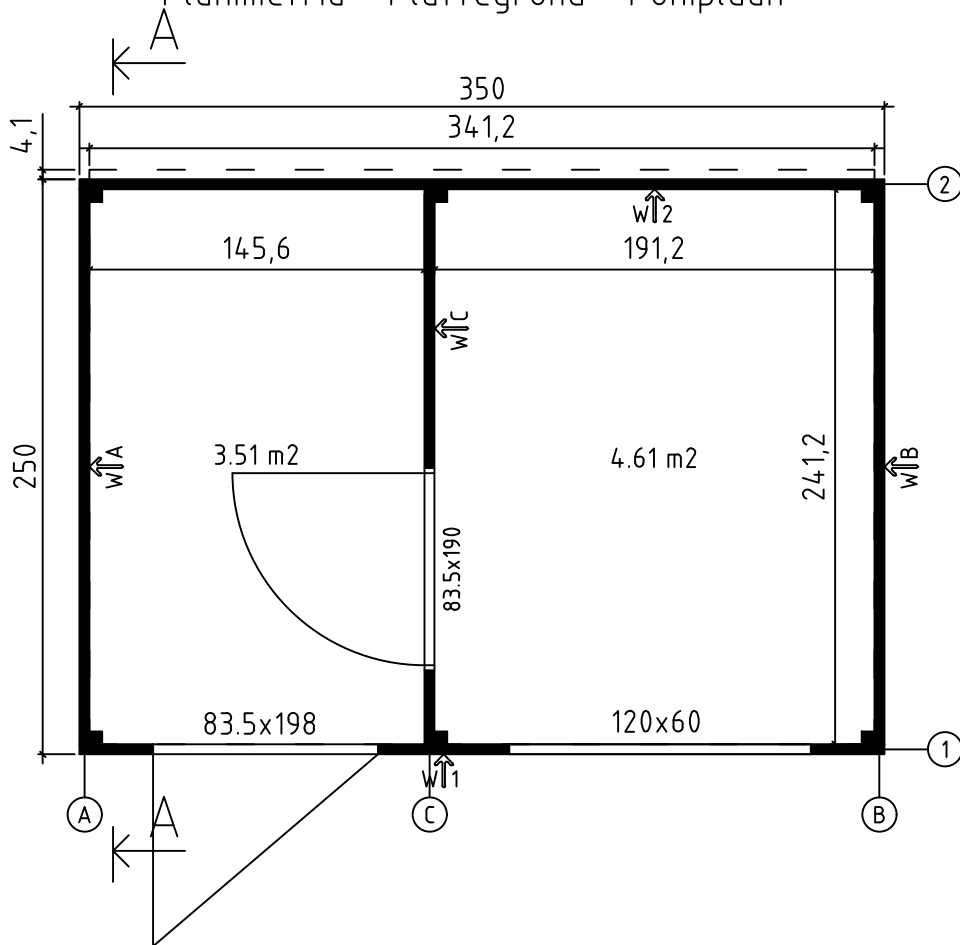

Foundation - Fundament - Fondation -
 Fondamenta - Fundering - Immutatud alusraam

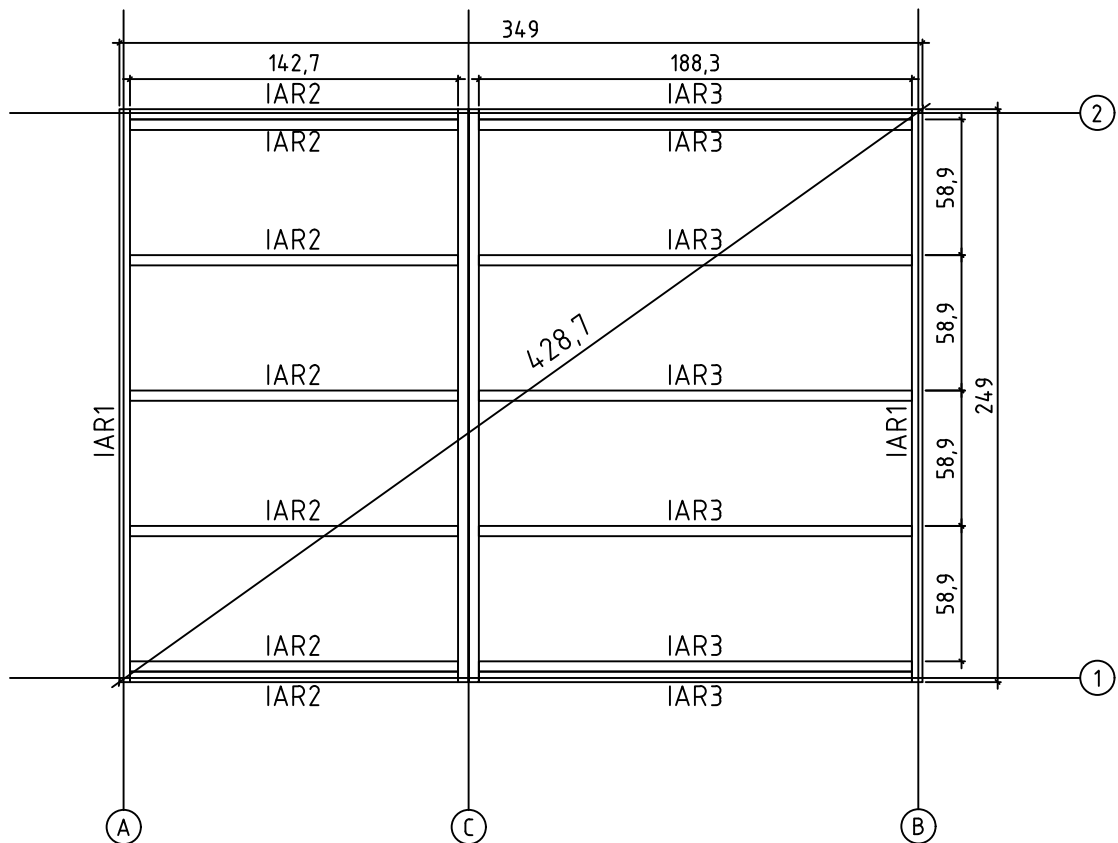

Floor boards - Fussbodenbretter - Plan pose plancher - Pavimento -
Vloerhout - Põrandalaudis

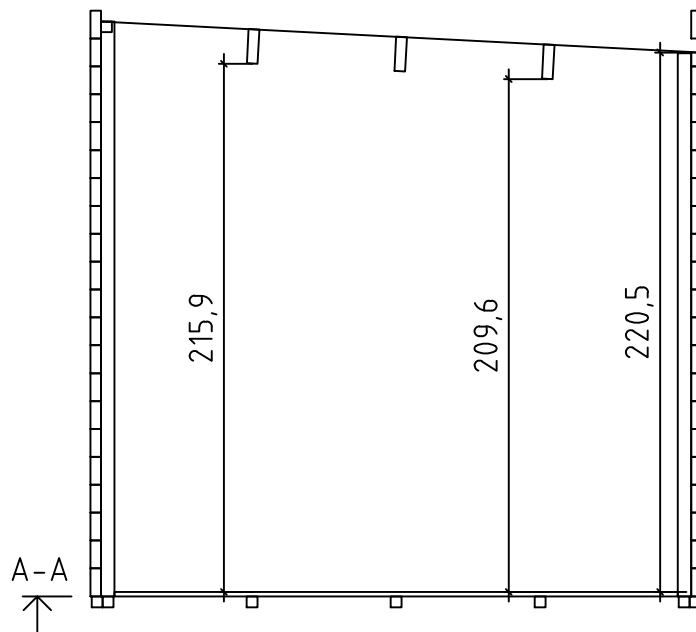
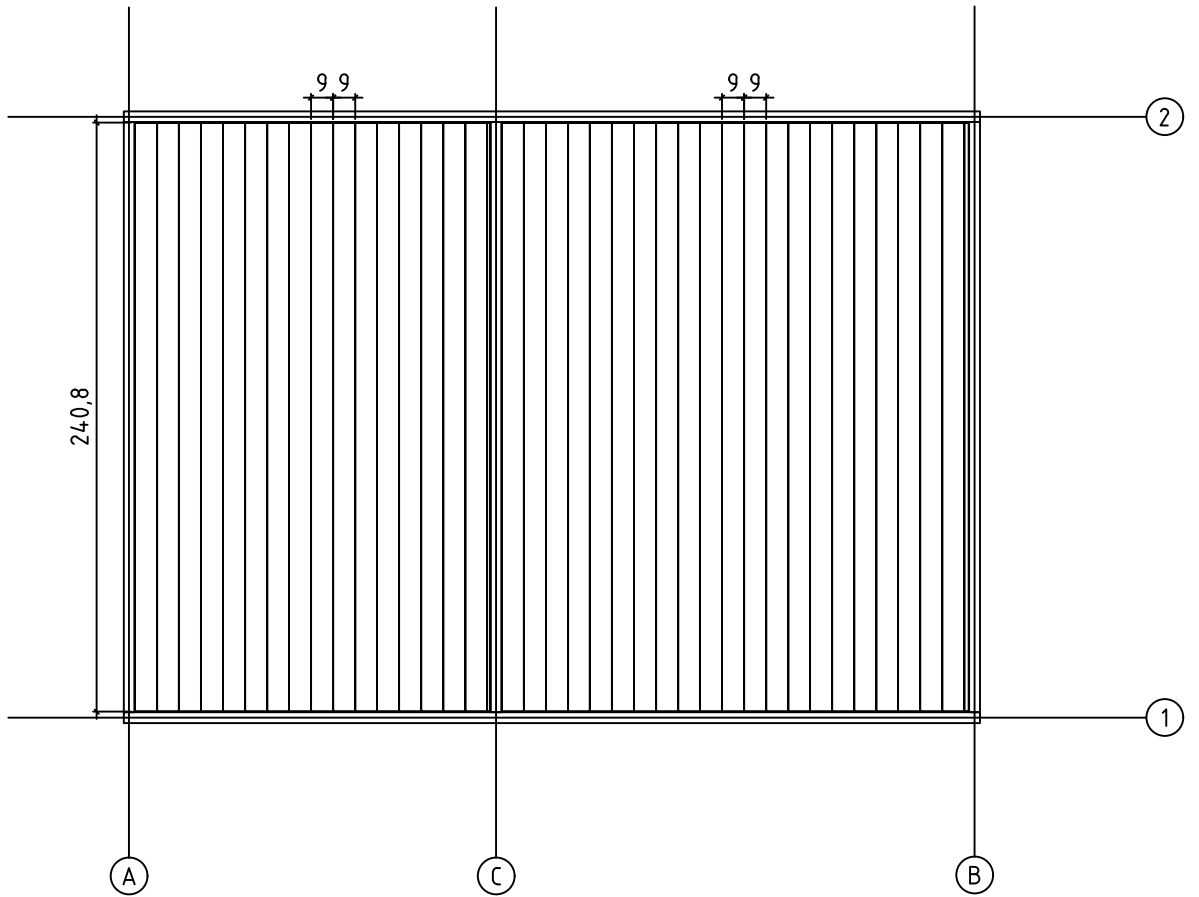

Without tongue - Ohne feder - Madrier de finition -
Finale in legno - Zonder veer - Punnita

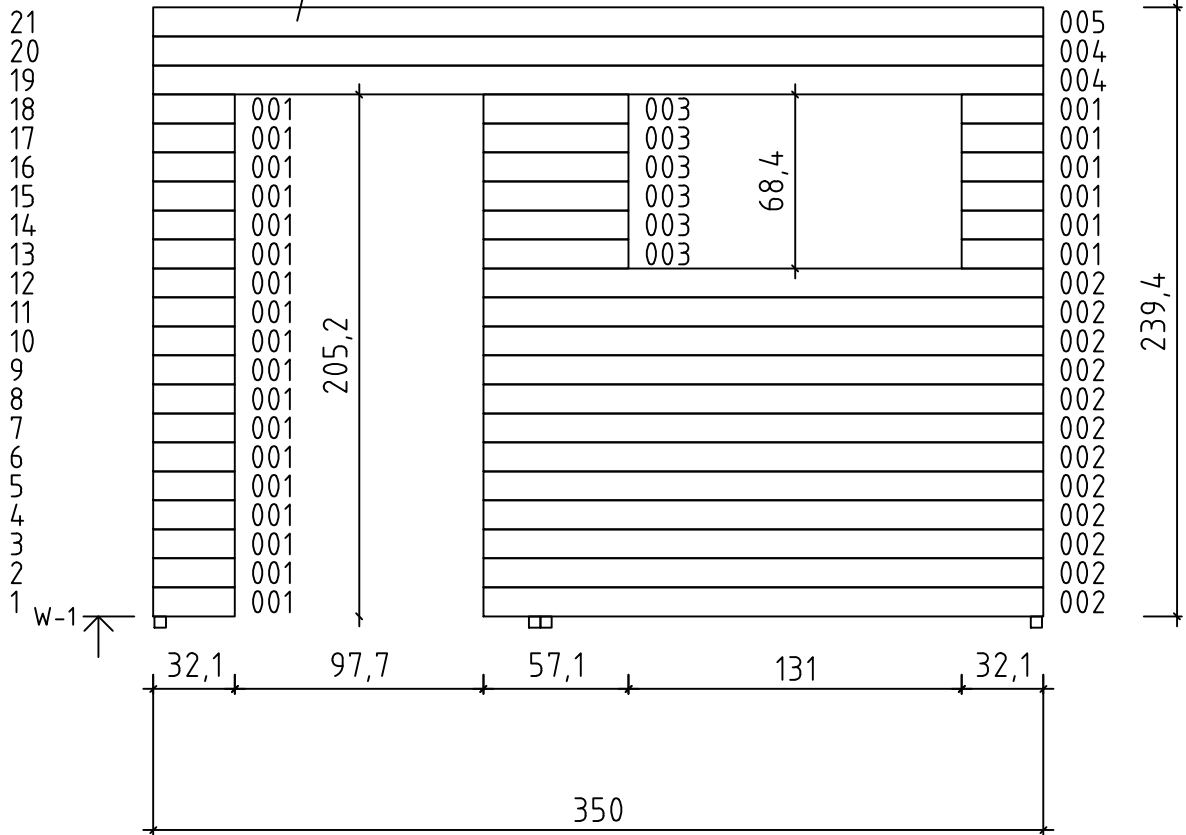



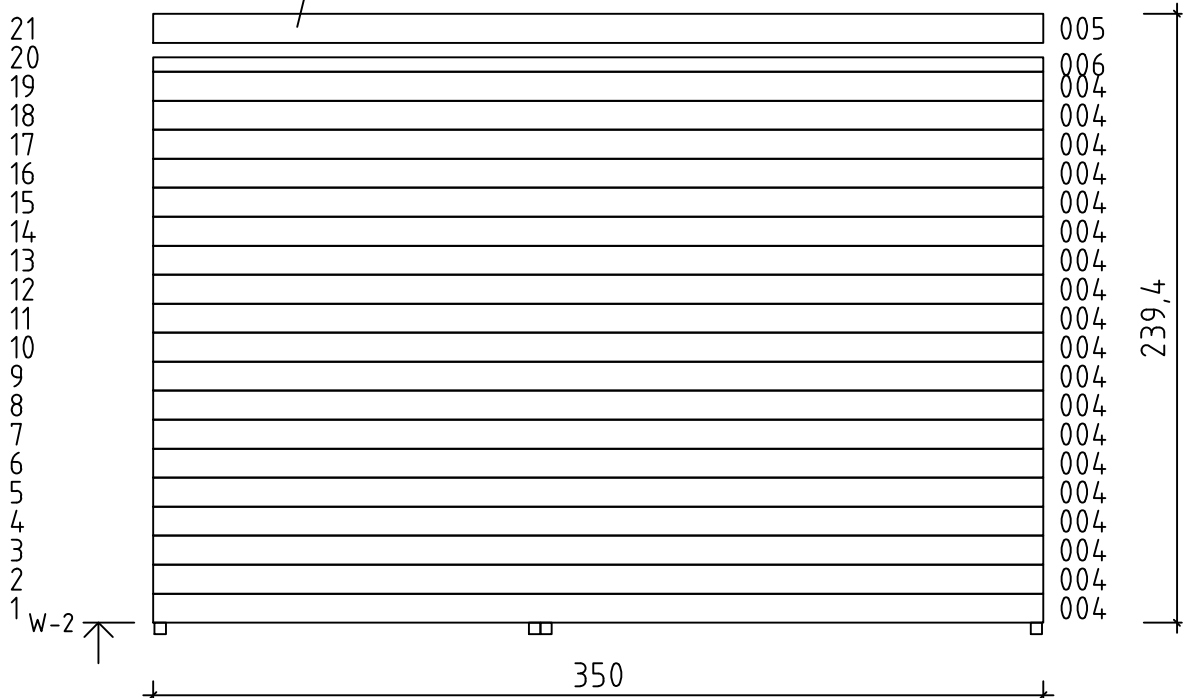



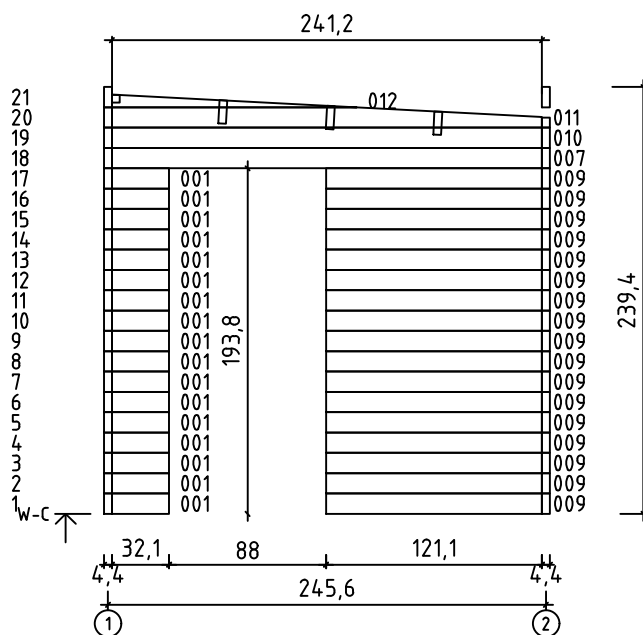
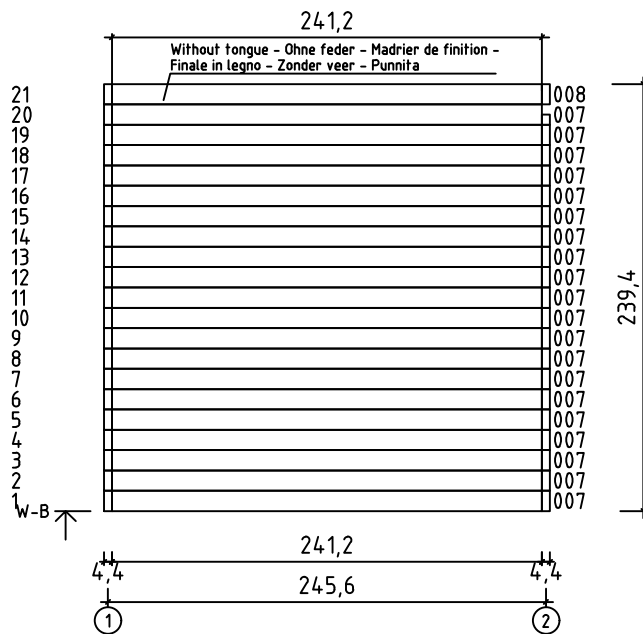
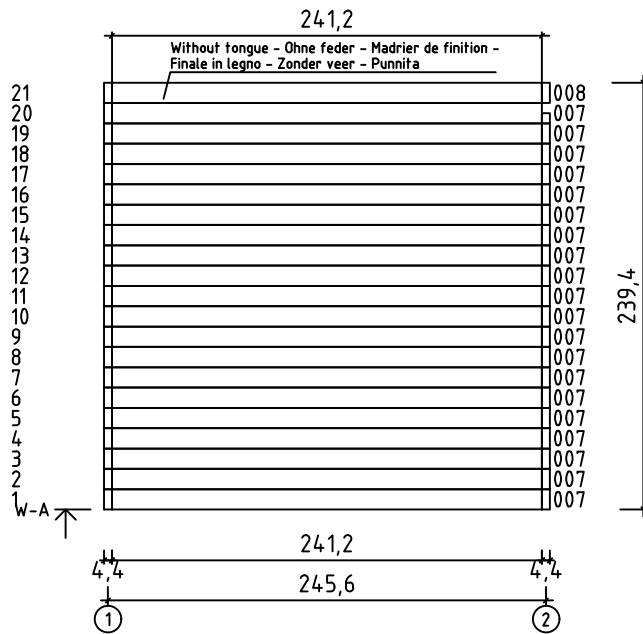

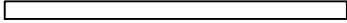

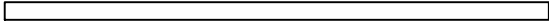
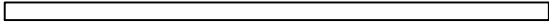
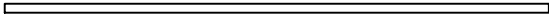
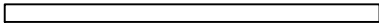
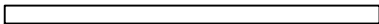
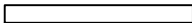
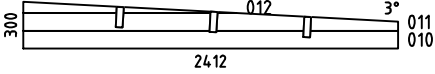
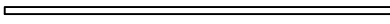

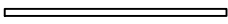
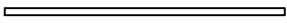
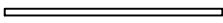
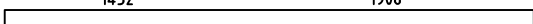
Without tongue - Ohne feder - Madrier de finition -
Finale in legno - Zonder veer - Punnita



Art. Nr. 4429519



Pos	09.05.2023 Piece list - Stückliste - Liste des pièces - Elementi - Stuklijst - Tükitalabel Art. Nr. 4429519 6/23	Q	P (mm)	L (mm)
001 880		41	44x114	321
002 44918		12	44x114	2202
003 5680		6	44x114	571
004 40161		21	44x114	3500
005 45922		2	44x114	3500
006 45923		1	44x57	3500
007 42579		41	44x114	2412
008 42580		2	44x114	2412
009 30162		17	44x114	1211
WC-1 45689		1		
IAR1 16635	Foundation - Fundament - Fondation - Fondamenta - Fundering - Immutatud alusraam 	4	45x45	2490
IAR3 43417	Foundation - Fundament - Fondation - Fondamenta - Fundering - Immutatud alusraam 	7	45x45	1883
IAR2 45925	Foundation - Fundament - Fondation - Fondamenta - Fundering - Immutatud alusraam 	7	45x45	1427
RV2 45924	Lath - Pfetten - Liteau - Piccola asse - Gordingen - Roov 	1	44x44	1802
RV1 45926	Lath - Pfetten - Liteau - Piccola asse - Gordingen - Roov 	1	44x44	1401
APR 45927	Roof beam - Dachbalken - Panne de toit - Perlina del tetto - Gordingen / dakbalk - Pärilin 1452 1908 	3	44x140	3404
FB 21996	Floor boards - Fussbodenbretter - Lame de plancher - Pavimento - Vloerhout - Põrandalaud 	39	90x18	2408
RB 1167	Roof boards - Dachbretter - Voliges - Perlina per tetto - Dakhout - Katuselaud 	38	90x18	2500
FL-1 30087	Floor fillet - Fussbodenteiste - Corniere de finition du plancher - Finitura per pavimento (battisco pa) - Vloerafwerkljst - Põrandaliist 		18x18	18
TL1 44946	Covering moulding - Deckungsprofil - Profils de finition verticaux a fixer a l'exterieur du cadre de la porte - Cornice di finitura - Afdek profiel - Lengipuu 	2	38x46	668
TL2 44947	Covering moulding - Deckungsprofil - Profils de finition verticaux a fixer a l'exterieur du cadre de la porte - Cornice di finitura - Afdek profiel - Lengipuu 	2	38x46	1212
CF1 38450	Corner fillet - Deckleiste - Profils de finition angles a l'exterieur - Massello d'angolo - (hoek)lijst - Nurgaliist 	1	15x45	2203
CF2 45472	Corner fillet - Deckleiste - Profils de finition angles a l'exterieur - Massello d'angolo - (hoek)lijst - Nurgaliist 	1	15x45	2280

Pos	09.05.2023 Piece list - Stückliste - Liste des pièces - Elementi - Stuklijst - Tükítabel Art. Nr. 4429519 7/23	Q	P (mm)	L (mm)
TL3 45906	Covering moulding - Deckungsprofil - Profils de finition verticaux a fixer a l'exterieur du cadre de la porte - Cornice di finitura - Afdek profiel - Lengipuu 	1	30x46	871
TL4 45641	Covering moulding - Deckungsprofil - Profils de finition verticaux a fixer a l'exterieur du cadre de la porte - Cornice di finitura - Afdek profiel - Lengipuu 	2	30x46	2028
FF3 45907	Fillet for terrace railing - Leiste für terrasse - Baguette pour corps de terrasse - Massellino di guarnizione per ringhiera - Terras lijst - Piirde liist 	1	18x70	835
FF4 43519	Fillet for terrace railing - Leiste für terrasse - Baguette pour corps de terrasse - Massellino di guarnizione per ringhiera - Terras lijst - Piirde liist 	2	18x70	1998
PL1 44930	Railing strip - Begrenzungsleiste - Rembarde - Sbarra - Afscheidingslijst - Piirdelaud 	4	18x70	695
PL2 44931	Railing strip - Begrenzungsleiste - Rembarde - Sbarra - Afscheidingslijst - Piirdelaud 	1	18x70	1200
PL3 44932	Railing strip - Begrenzungsleiste - Rembarde - Sbarra - Afscheidingslijst - Piirdelaud 	1	18x70	1212
PL4 42938	Railing strip - Begrenzungsleiste - Rembarde - Sbarra - Afscheidingslijst - Piirdelaud 	2	18x70	1980
PL5 37811	Railing strip - Begrenzungsleiste - Rembarde - Sbarra - Afscheidingslijst - Piirdelaud 	2	18x90	1065
PL6 44933	Railing strip - Begrenzungsleiste - Rembarde - Sbarra - Afscheidingslijst - Piirdelaud 	2	18x90	1402
PL7 45727	Railing strip - Begrenzungsleiste - Rembarde - Sbarra - Afscheidingslijst - Piirdelaud 	2	18x90	1980
P1 44756	Post - Pfosten - Poteau - Piede registrabile - Stijl - Post 	3	55x55	2220
P2 44757	Post - Pfosten - Poteau - Piede registrabile - Stijl - Post 	3	55x55	2350
FS1 45725	Fascia sheet - Abschlussprofil - Profil de finition métallique pour débord de toiture - Scossalina di protezione dall'acqua per bordo di legno - Afdek profiel / boordprofiel - Räästaplekk 	2		2400
FS2 45928	Fascia sheet - Abschlussprofil - Profil de finition métallique pour débord de toiture - Scossalina di protezione dall'acqua per bordo di legno - Afdek profiel / boordprofiel - Räästaplekk 	4		1800
FF5 44213	Fixing fillet - Fixirungsleiste - Profil de fixation - Massello di fissaggio - Bevestiging lijstwerk - Tenderliist 	2	18x44	670
FF6 39848	Fixing fillet - Fixirungsleiste - Profil de fixation - Massello di fissaggio - Bevestiging lijstwerk - Tenderliist 	2	18x44	1900
FF7 23905	Fixing fillet - Fixirungsleiste - Profil de fixation - Massello di fissaggio - Bevestiging lijstwerk - Tenderliist 	2	18x44	2030
HS99 5602	Screw for fascia sheet - Schraube für abschlussprofil - Vis pour profil de finition métallique pour débord de toiture - Viti per fissare i folgi di gronda - Schroef voor afsluit (afdek)profiel - Katusekruvi 	100	4.8x28	
HS9 5106	Screw for door jamb - Schraube für türrahmen - Vis de fixation partie haute avec montants du cadre de porte - Viti x fissaggio montanti porte - Schroef voor deurkozijn - Kruvi ukse lengile 	12	3.5x50	
HS12 5109	Screw for covering moulding - Schrauben für deckungsprofil - Vis de fixation profils horizontaux haut intérieur et extérieur d'encadrement de porte - Vite per cornice di copertura - Schroef voor afdekprofiel - Kruvi piirdelauale 	80	4x40	
HS12 5109	Screw for beam holder - Schrauben für balkenhalter - Vis de fixation support "u" galvanisé - Vite per trave di sostegno - Schroef voor bevestiging balkhouder (gordingschoen) - Kruvi talakingale 	84	4x40	
HS12 5109	Screw for fixing fillet of door and window - Schrauben für fixirungsleiste - Vis pour profil vertical de fixation pour ouvertures des fenetres et portes - Viti per massello di fissaggio - Schroeven voor bevestiging van deur en raam lijsten - Kruvi tenderliistudele 	100	4x40	

Art. Nr. 4429519

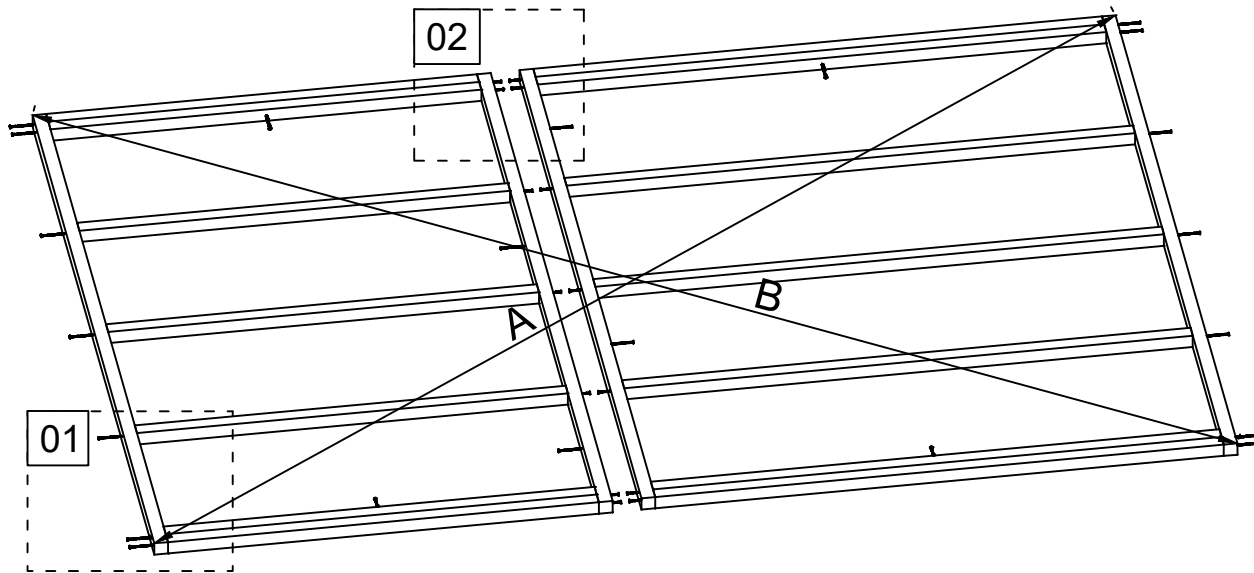

A=B

09.05.2023

01

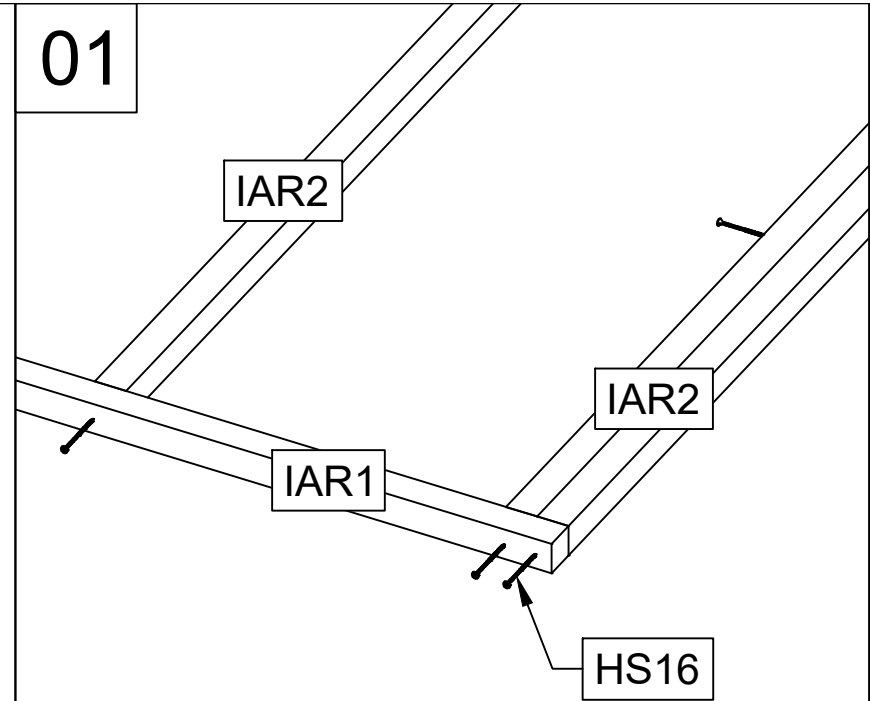

02

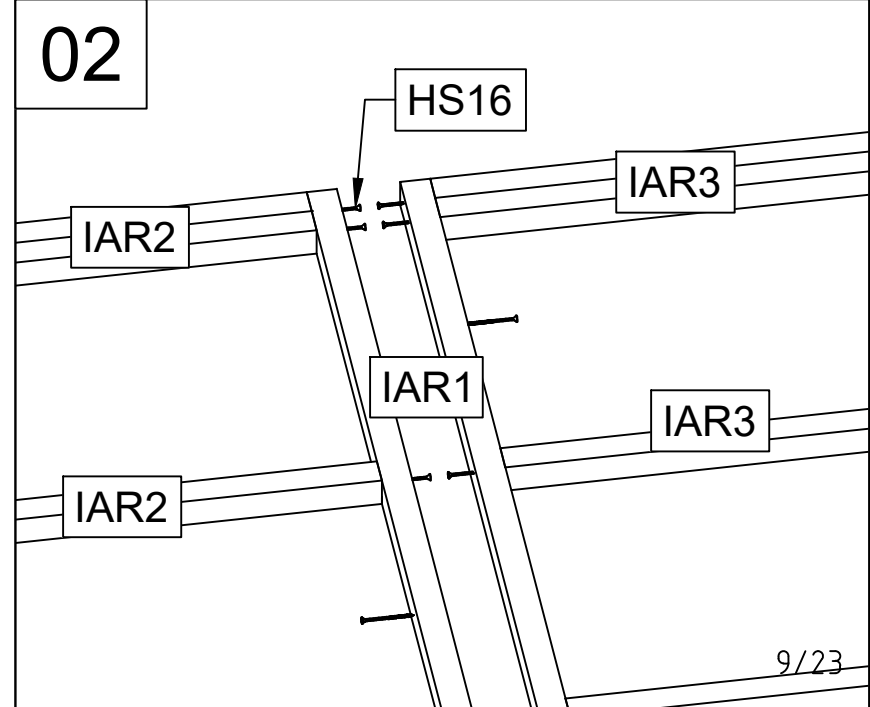

9/23

Art. Nr. 4429519

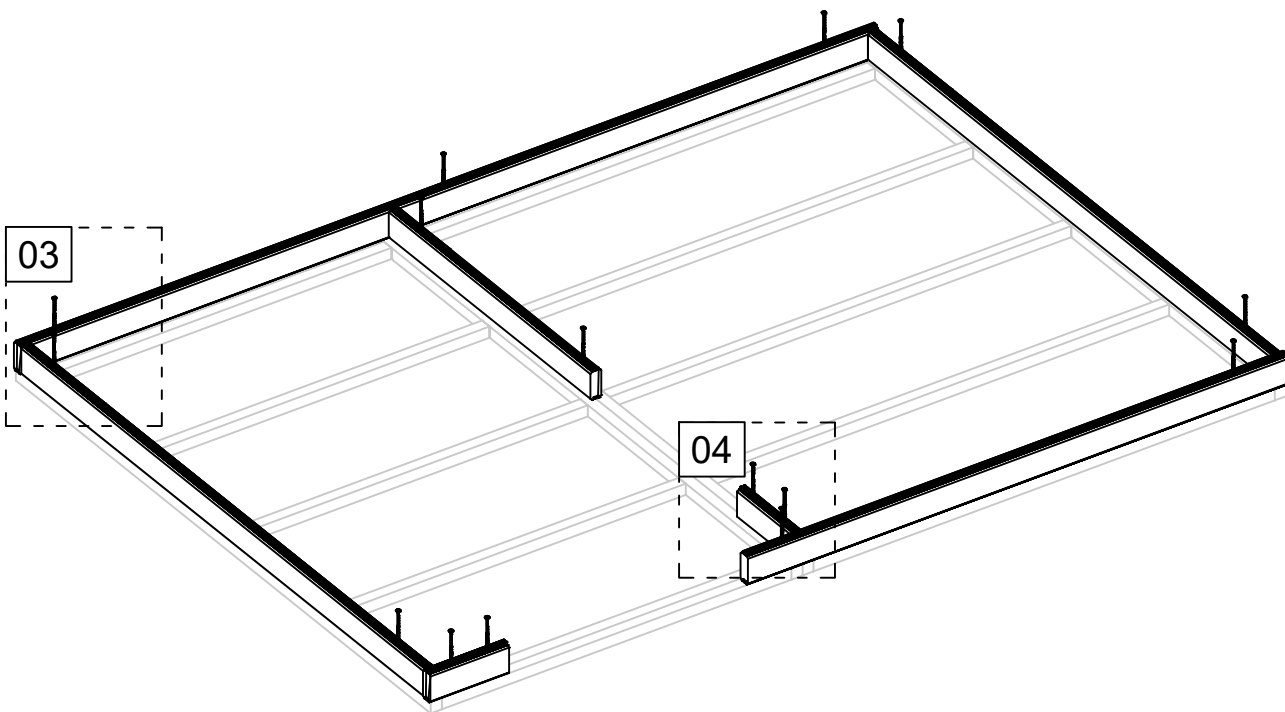

03

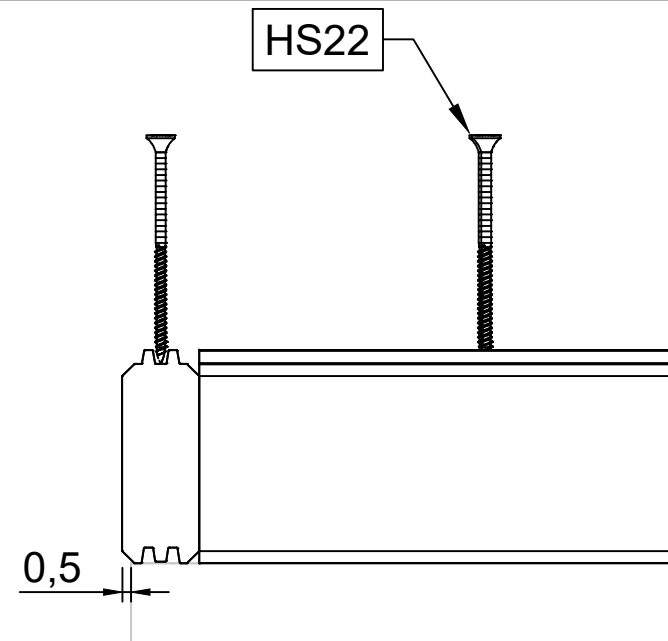

04

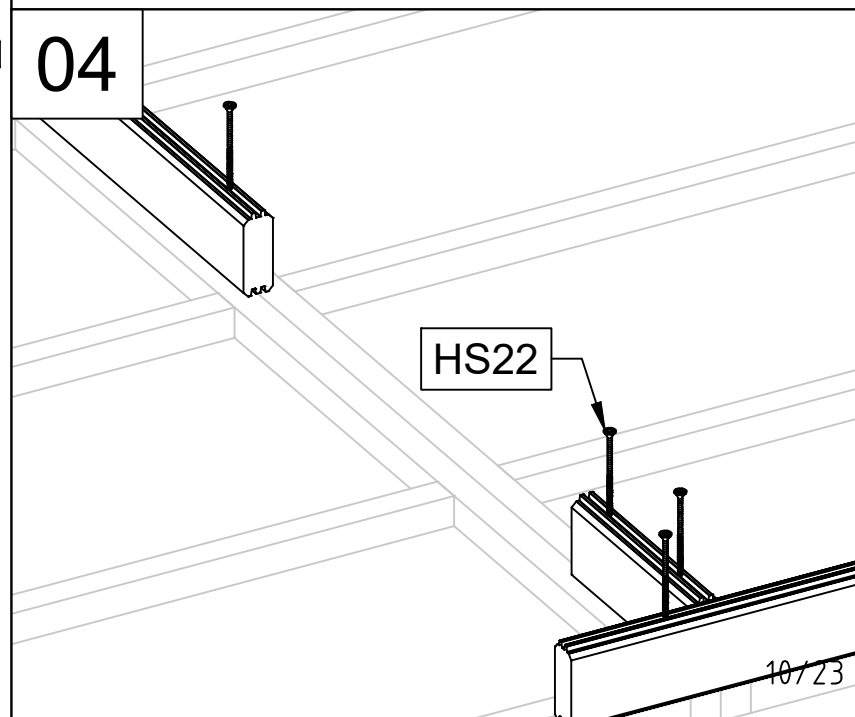

09.05.2023

10/23

Art. Nr. 4429519

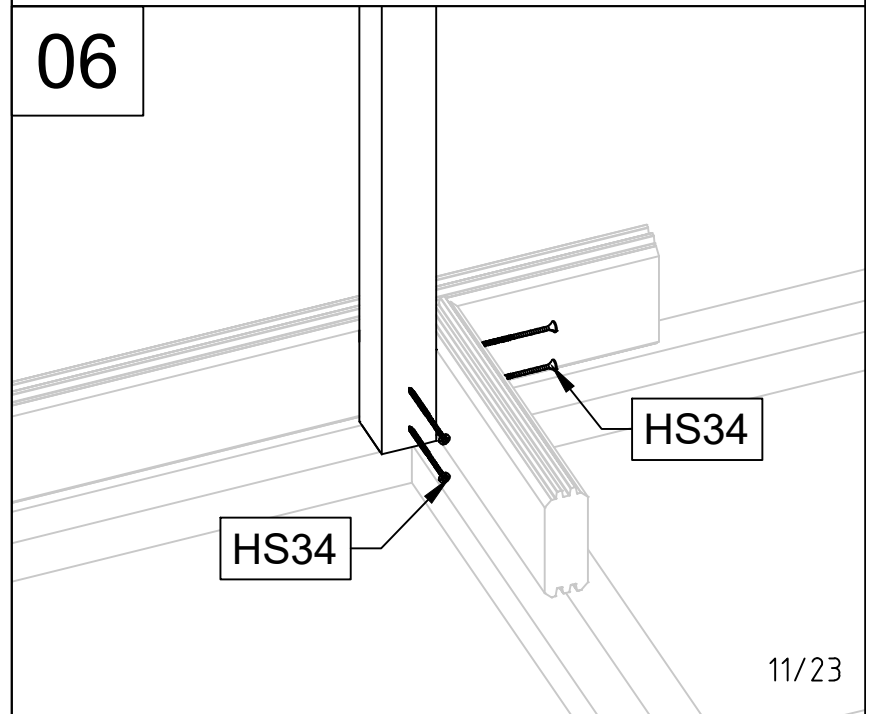
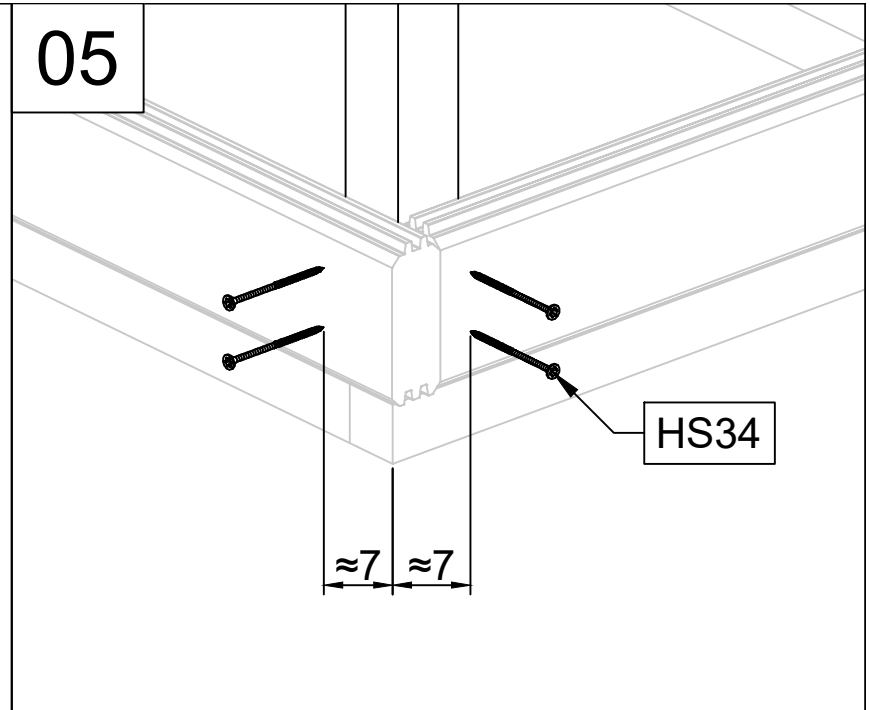
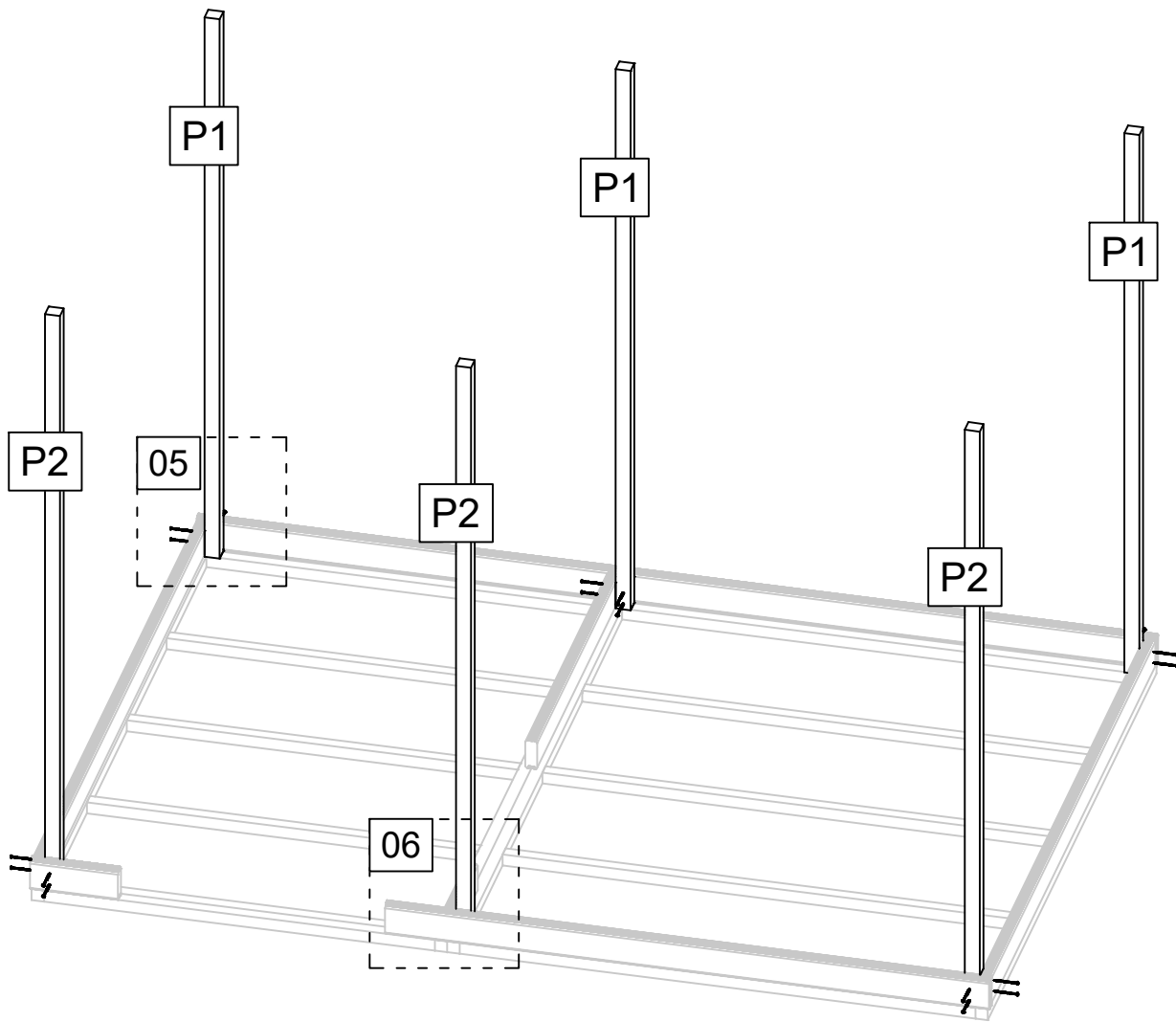

Art. Nr. 4429519

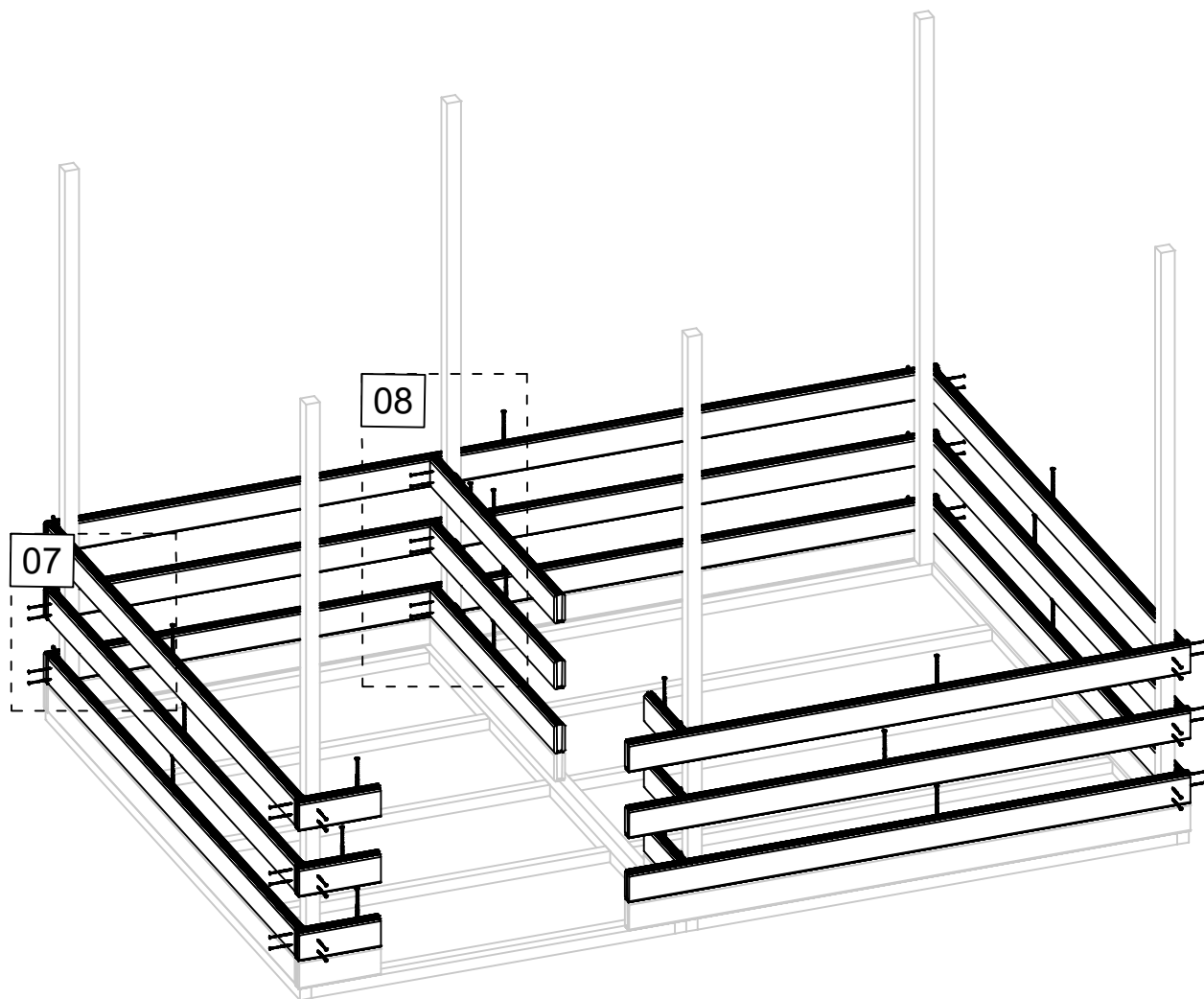

09.05.2023

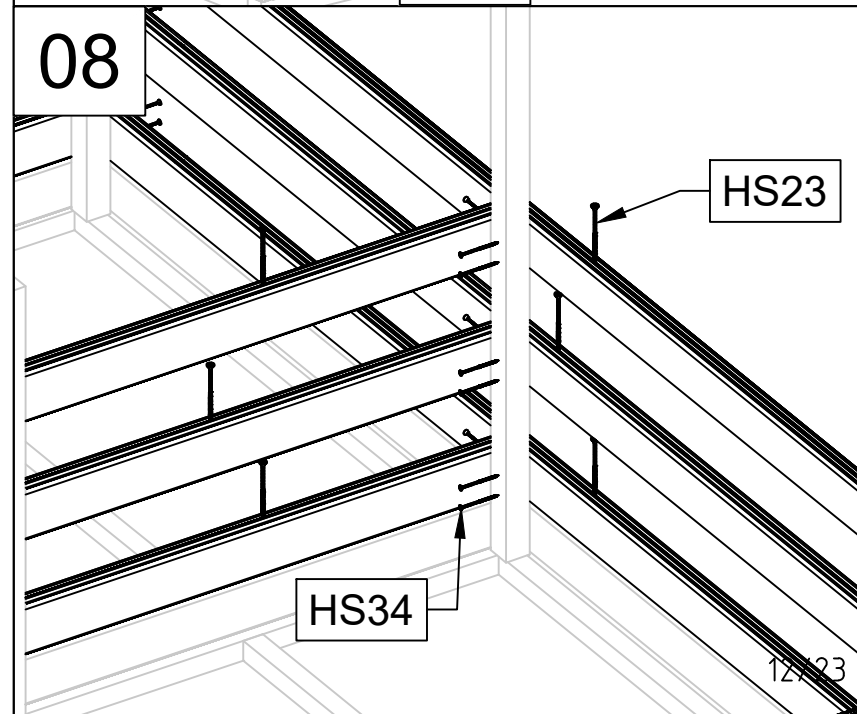
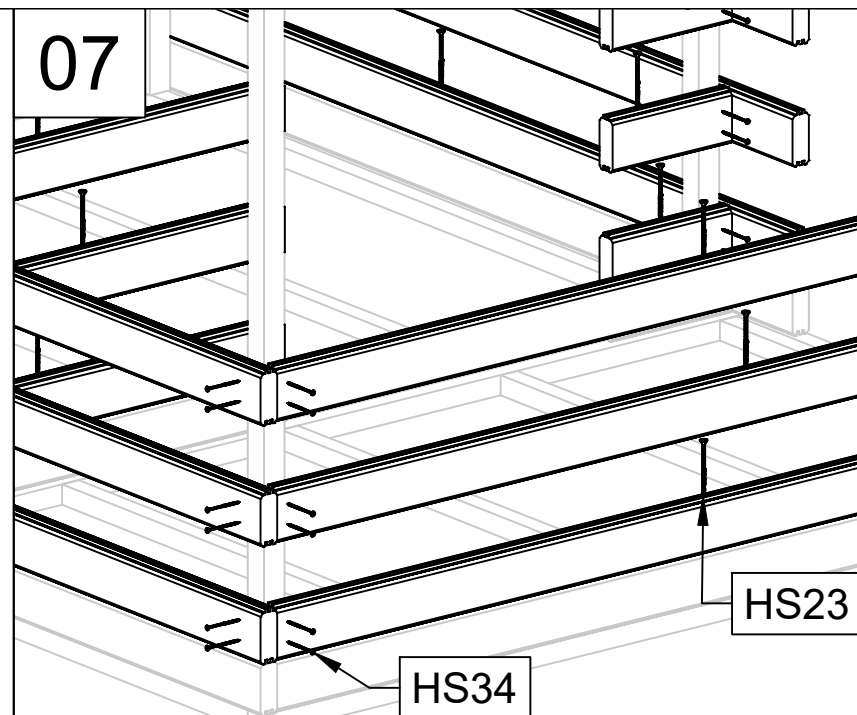

12/23

Art. Nr. 4429519

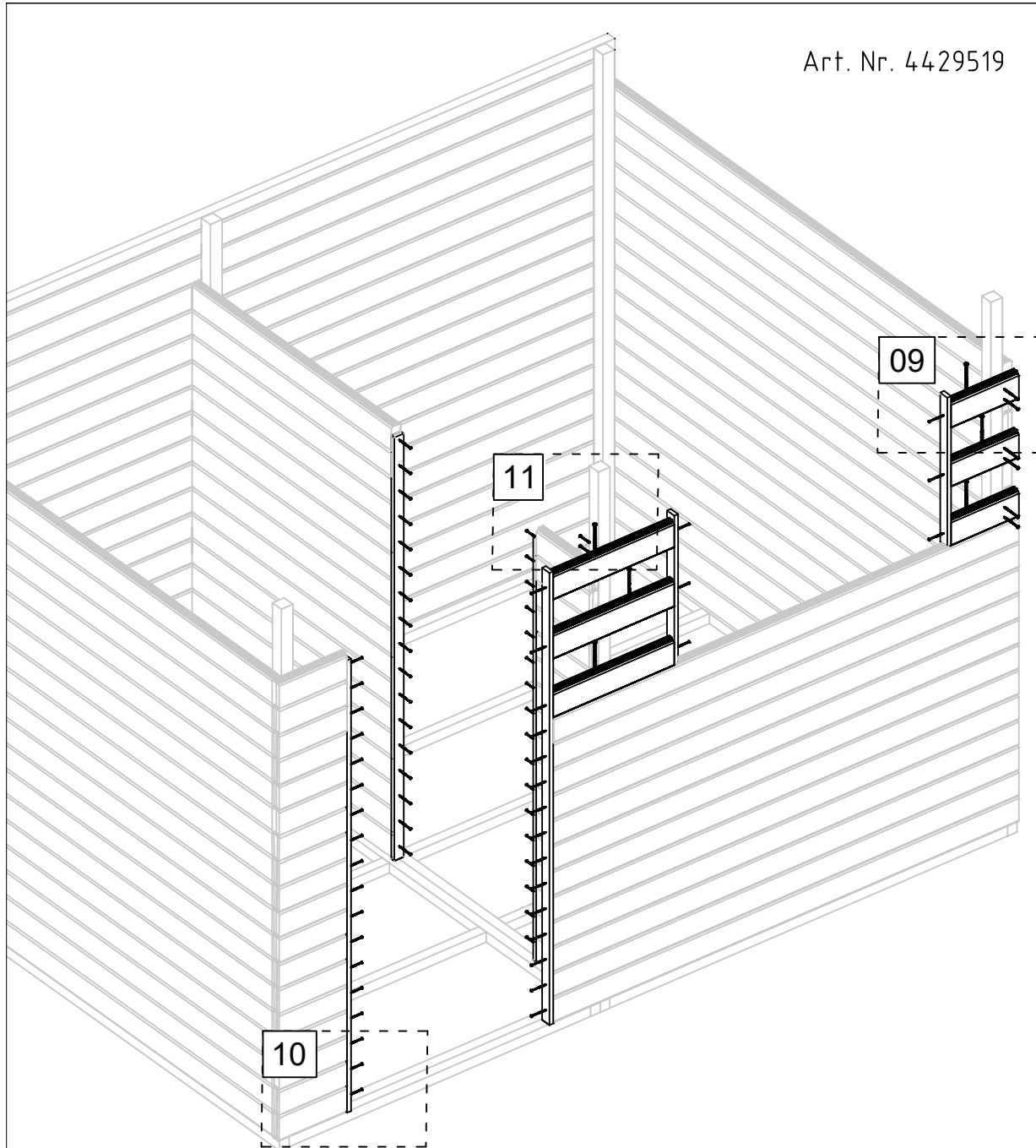

09.05.2023

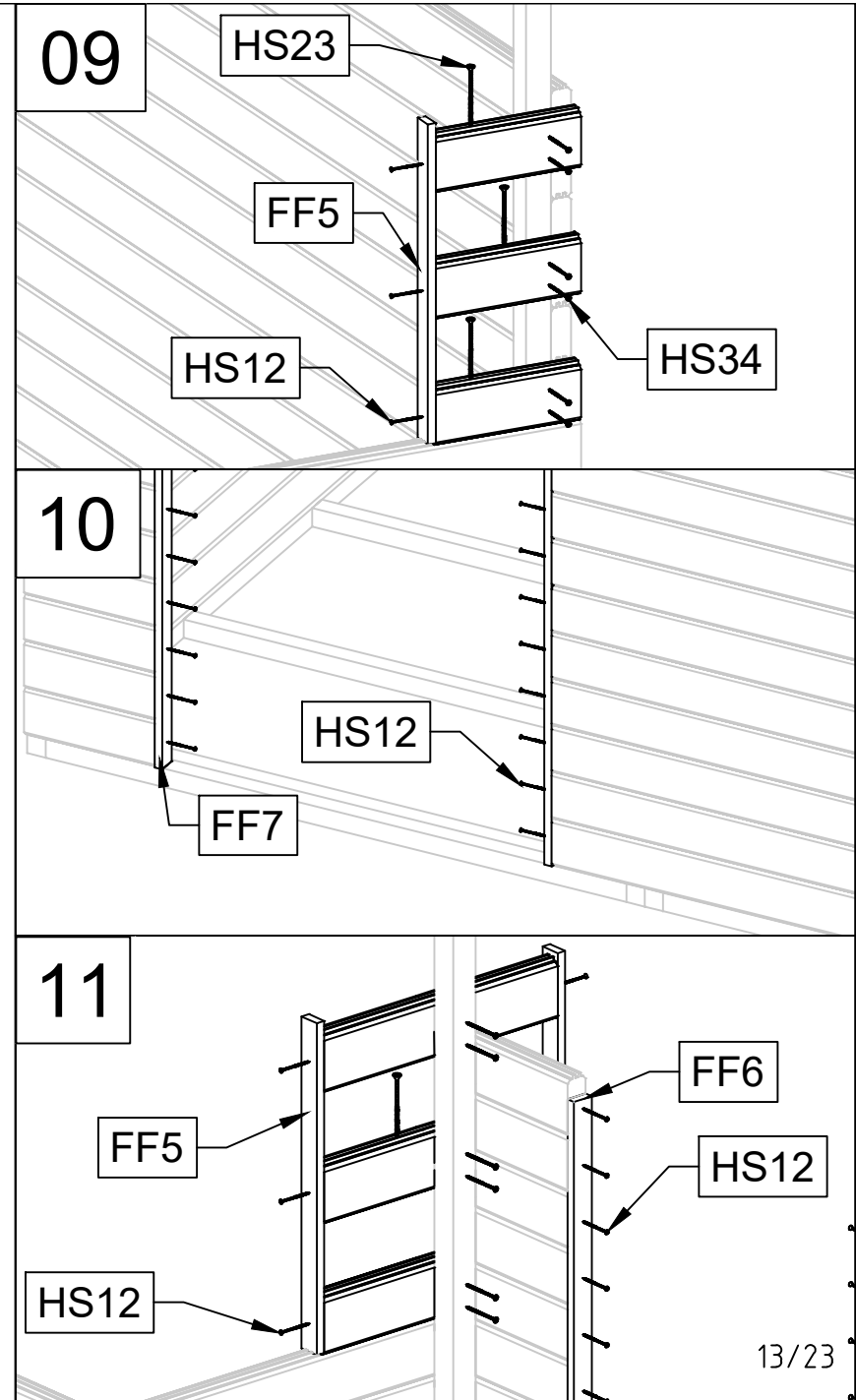

13/23

Art. Nr. 4429519

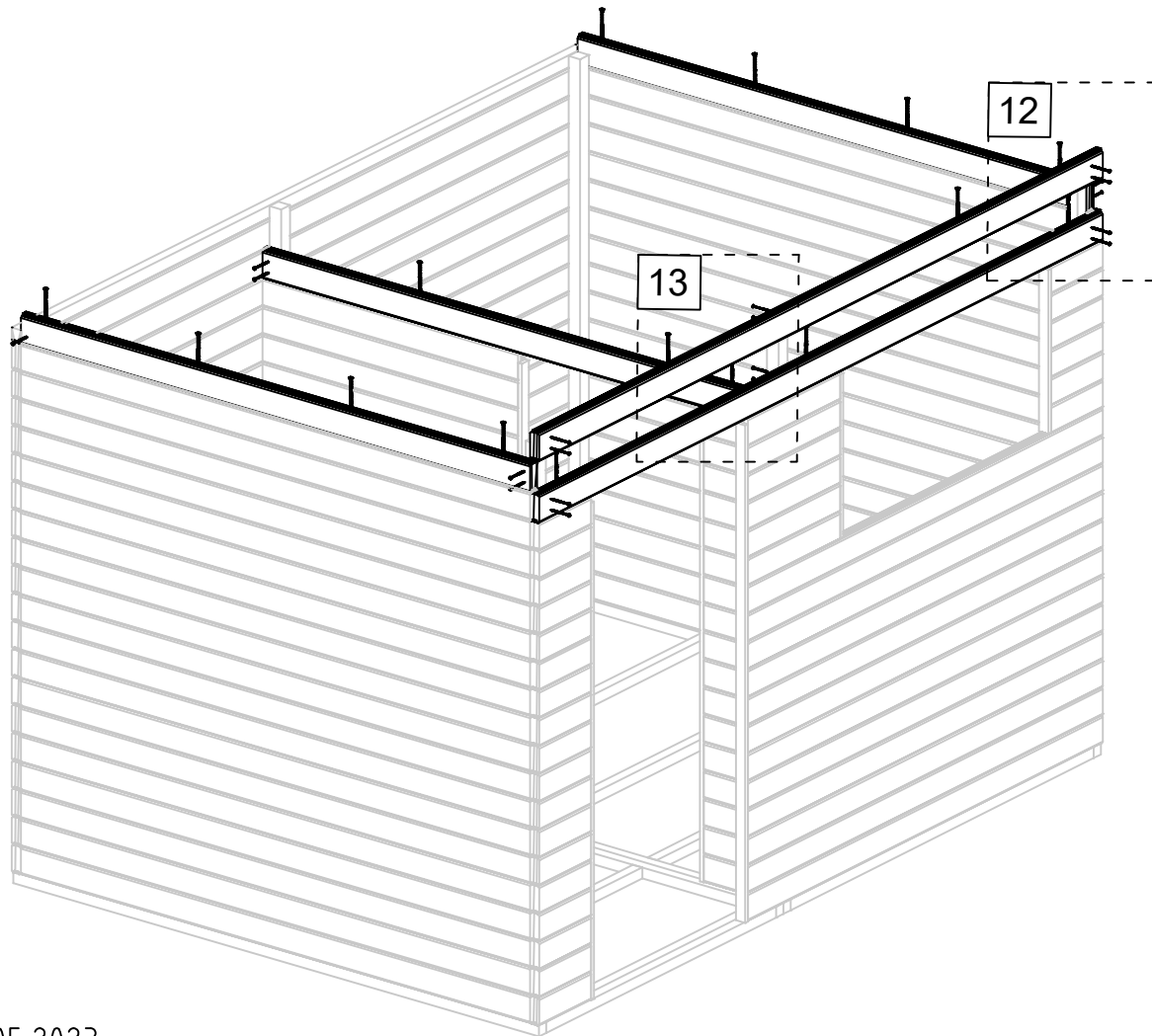

12

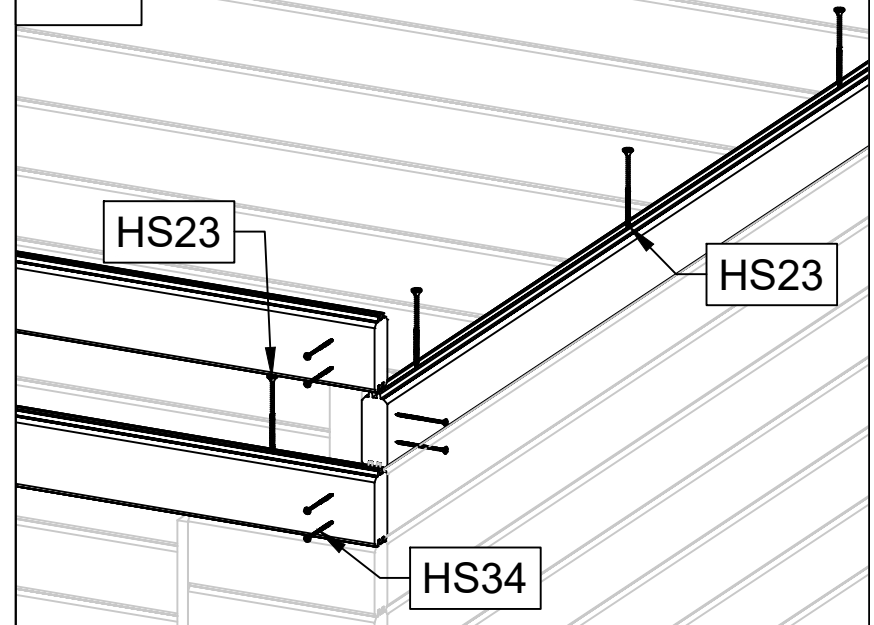

13

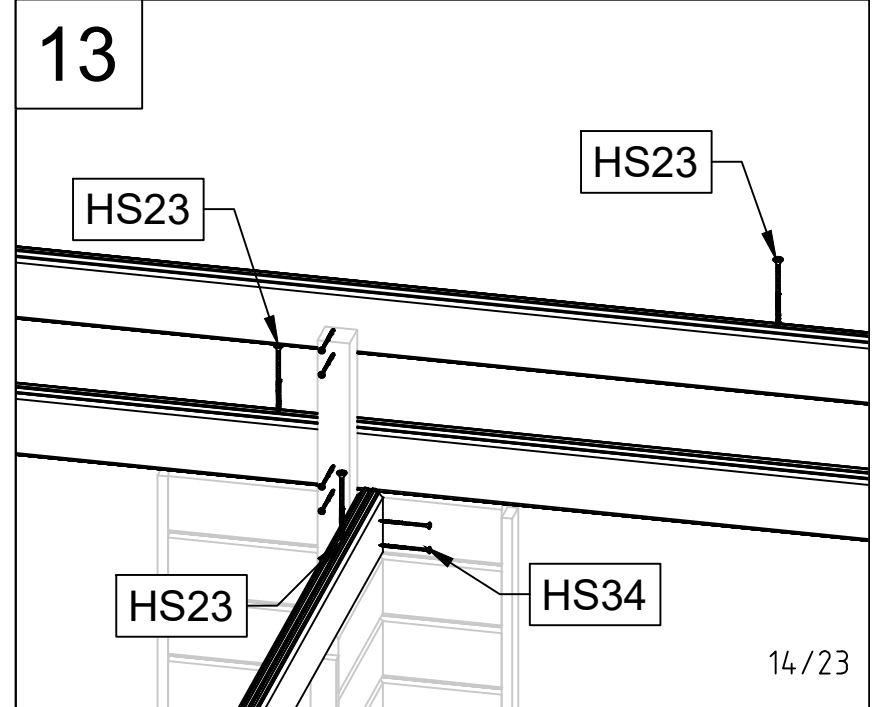

Art. Nr. 4429519

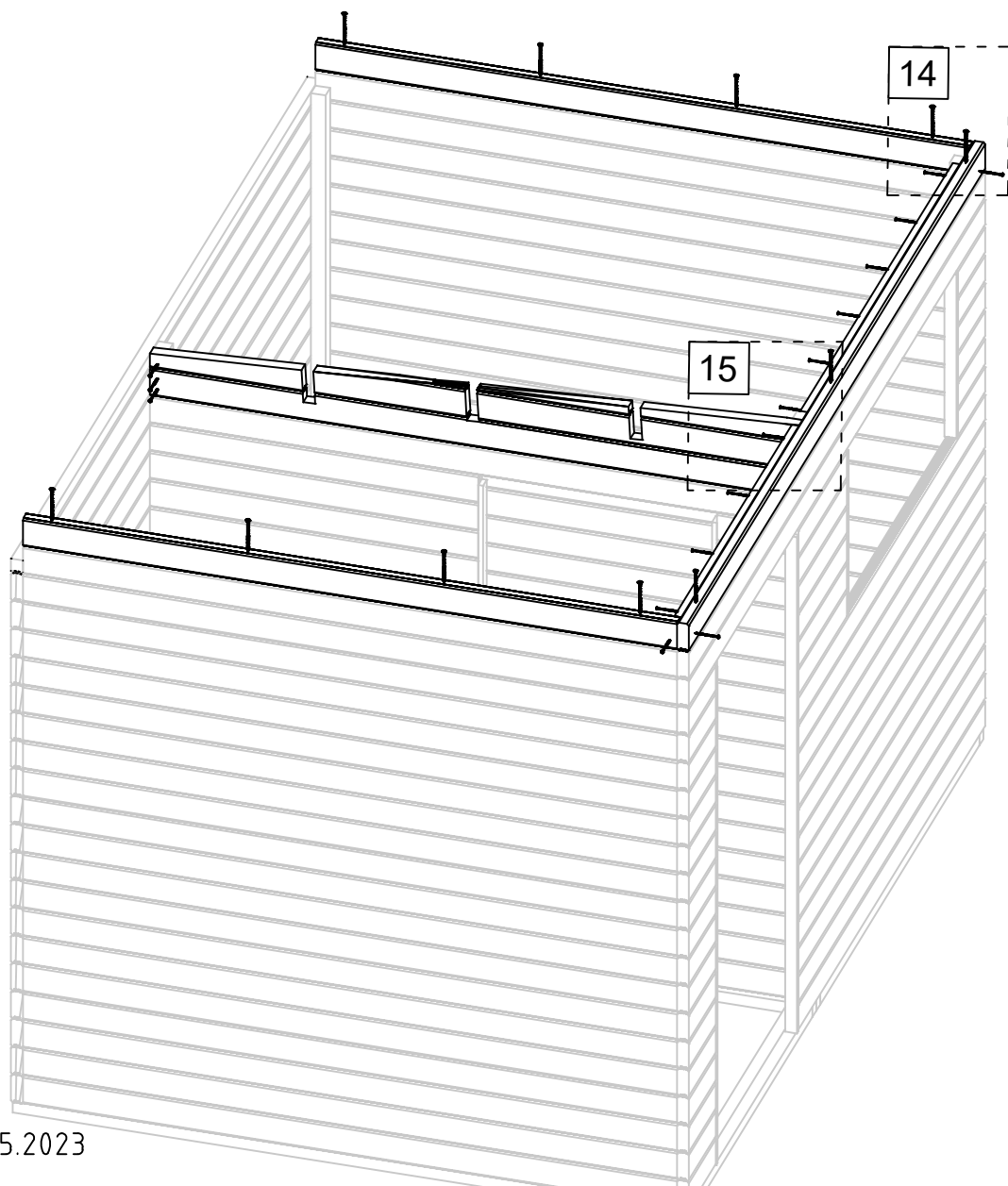

14

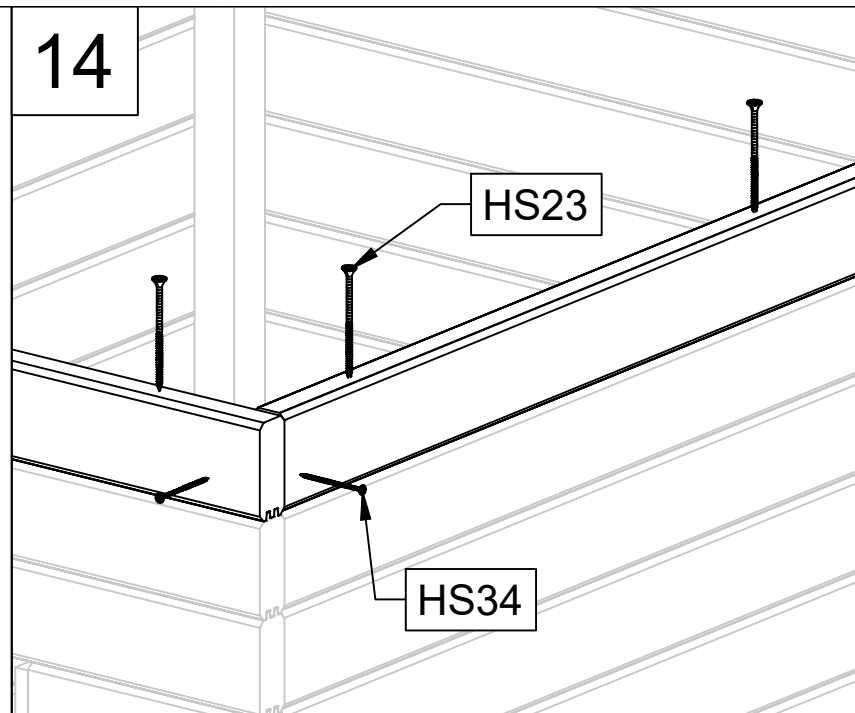

15

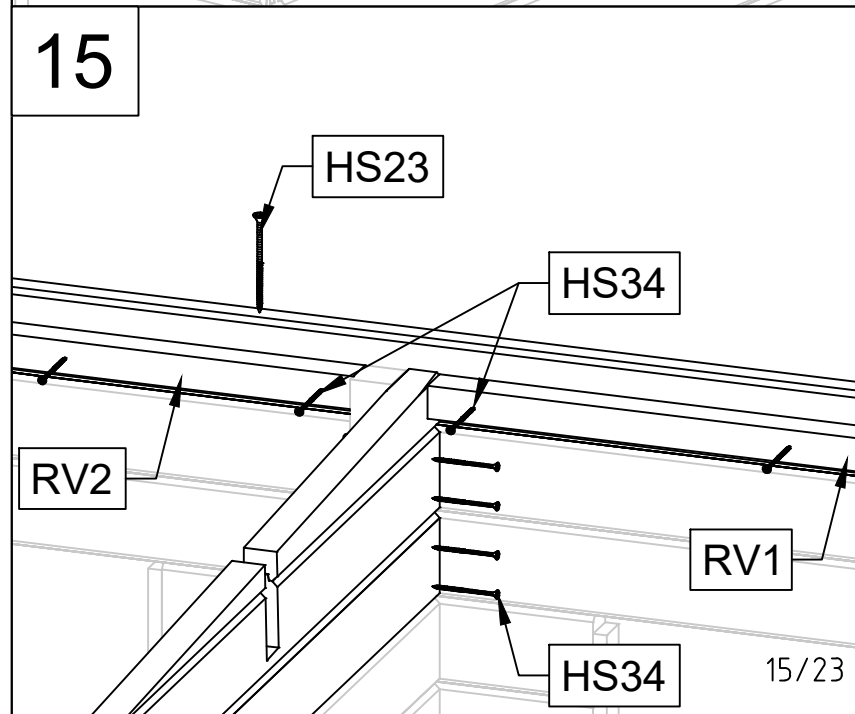

09.05.2023

15/23

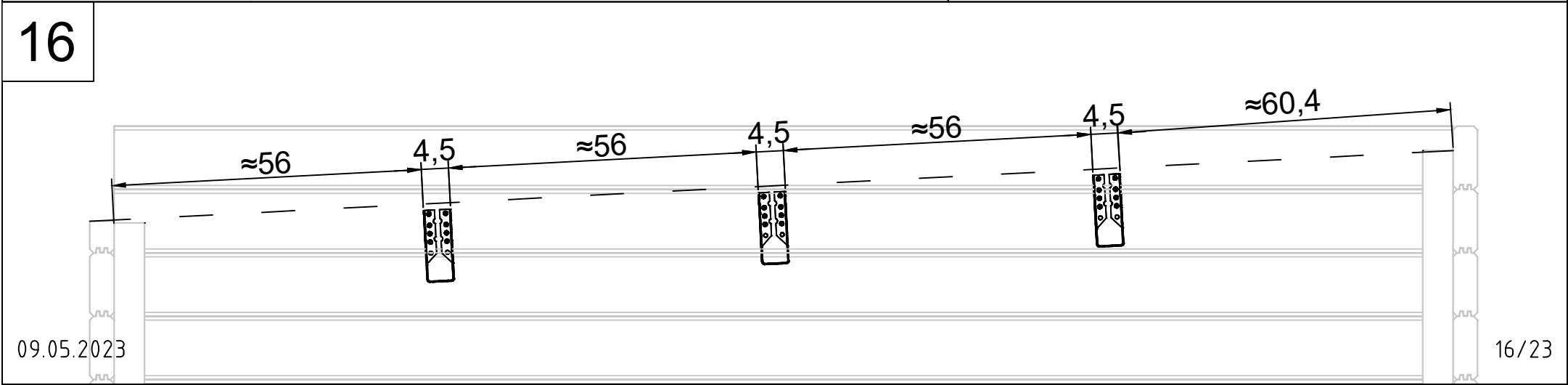
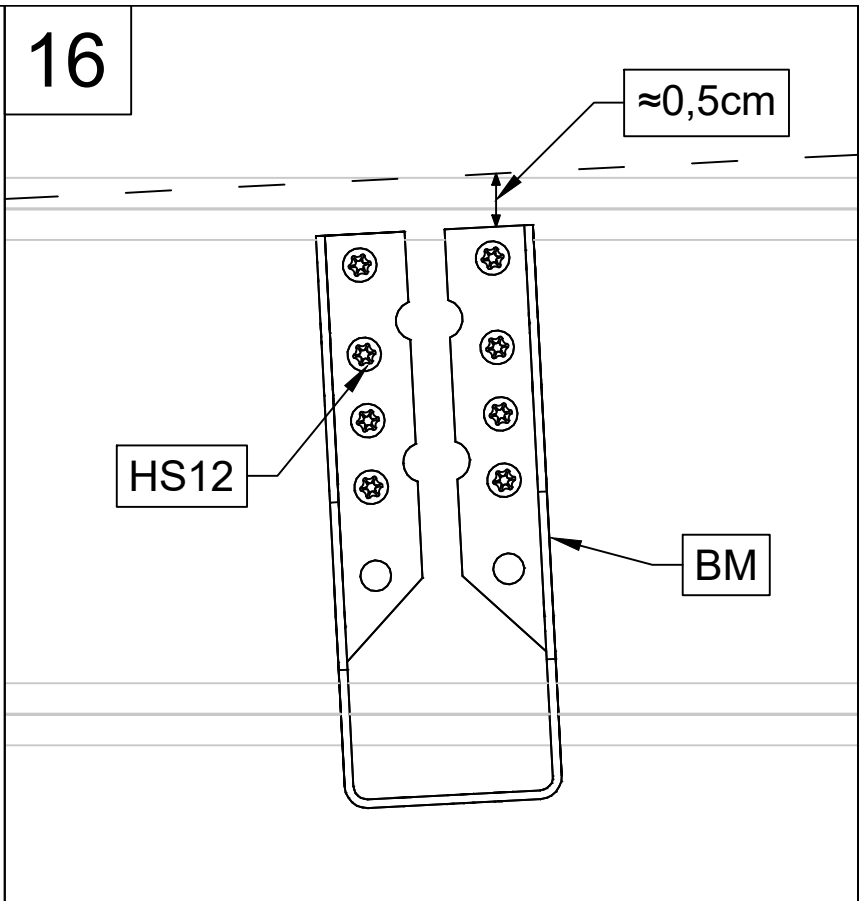
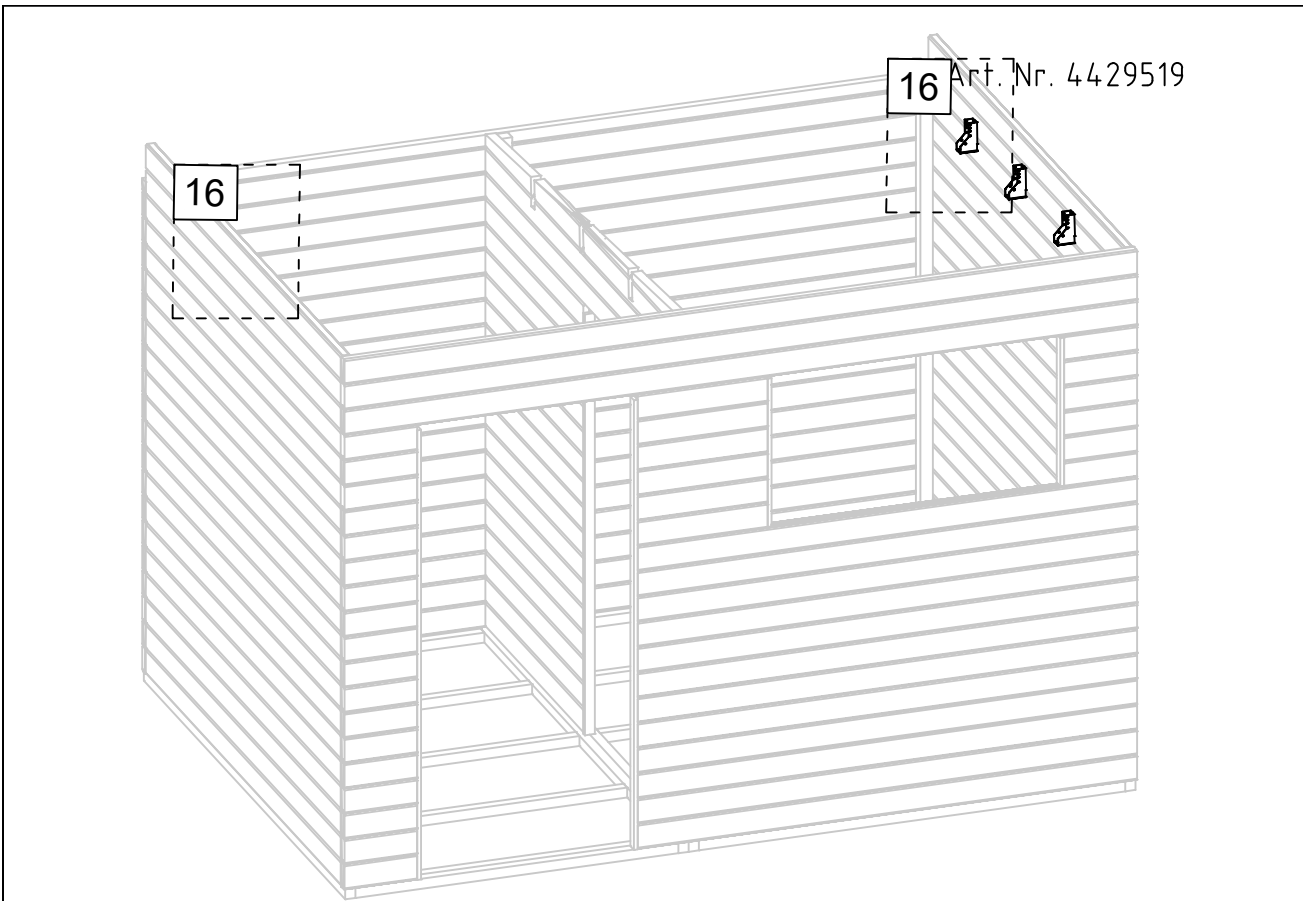

Art. Nr. 4429519

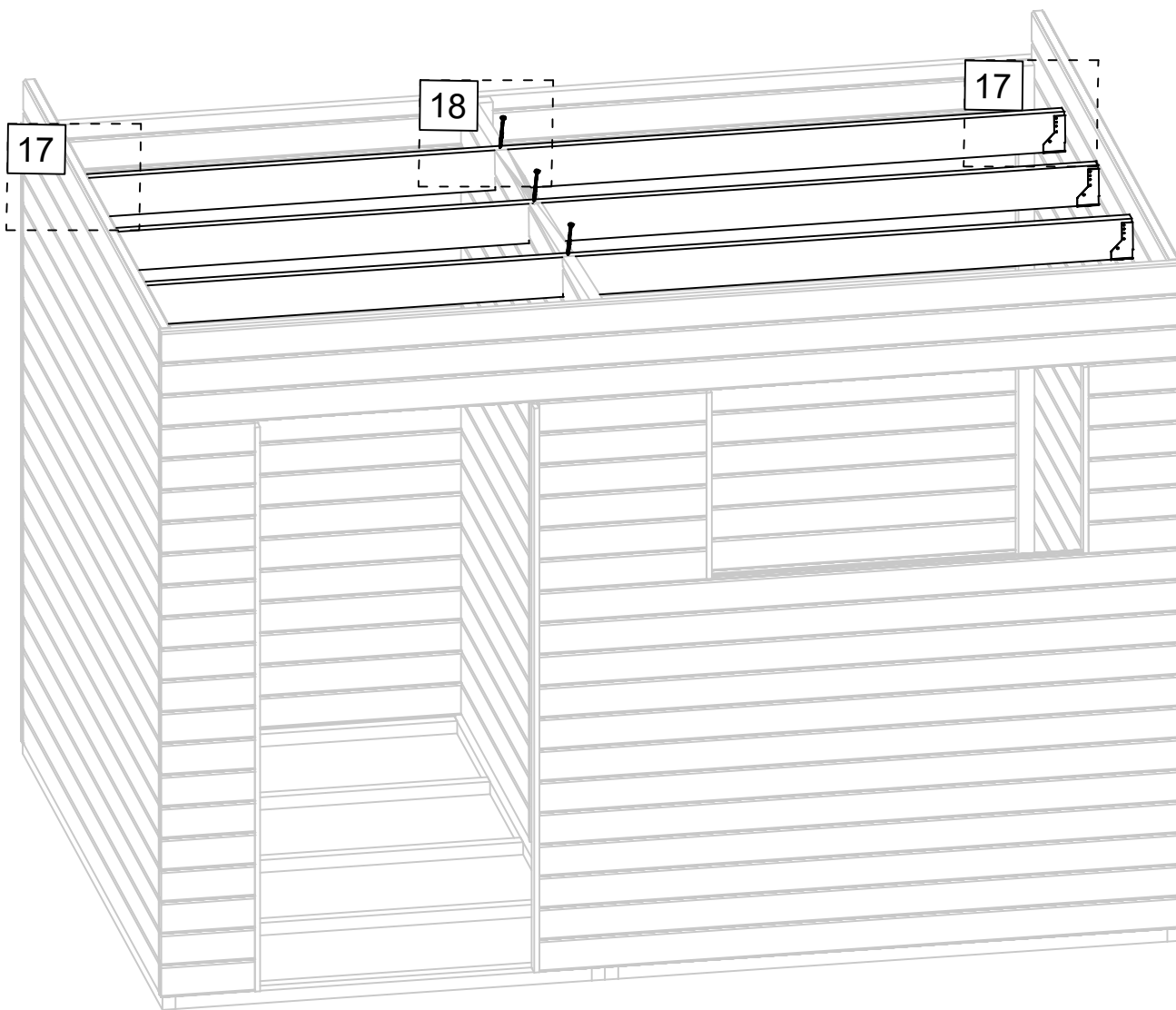

17

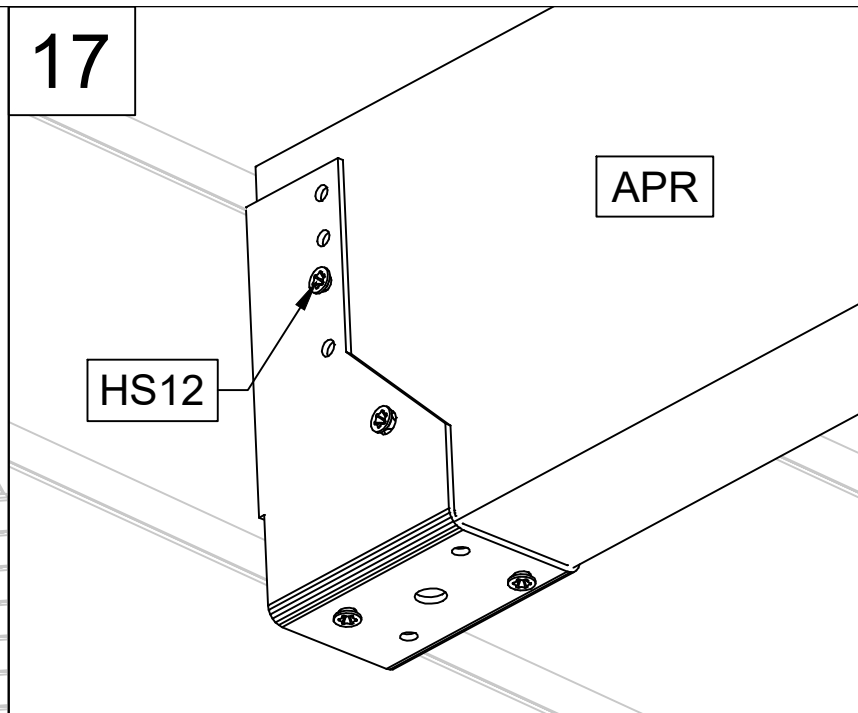

HS12

APR

18

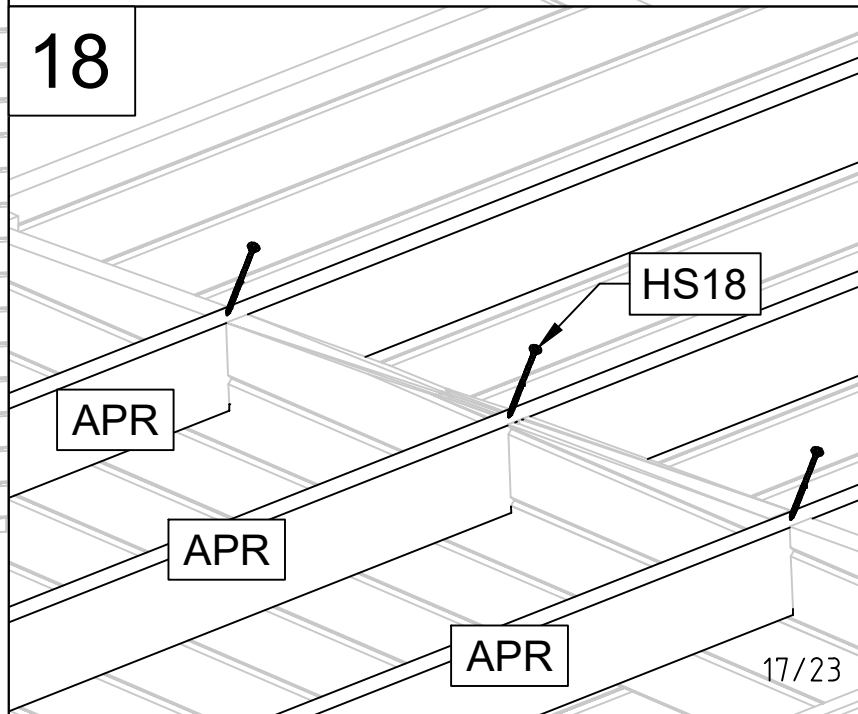

APR

HS18

APR

APR

Art. Nr. 4429519

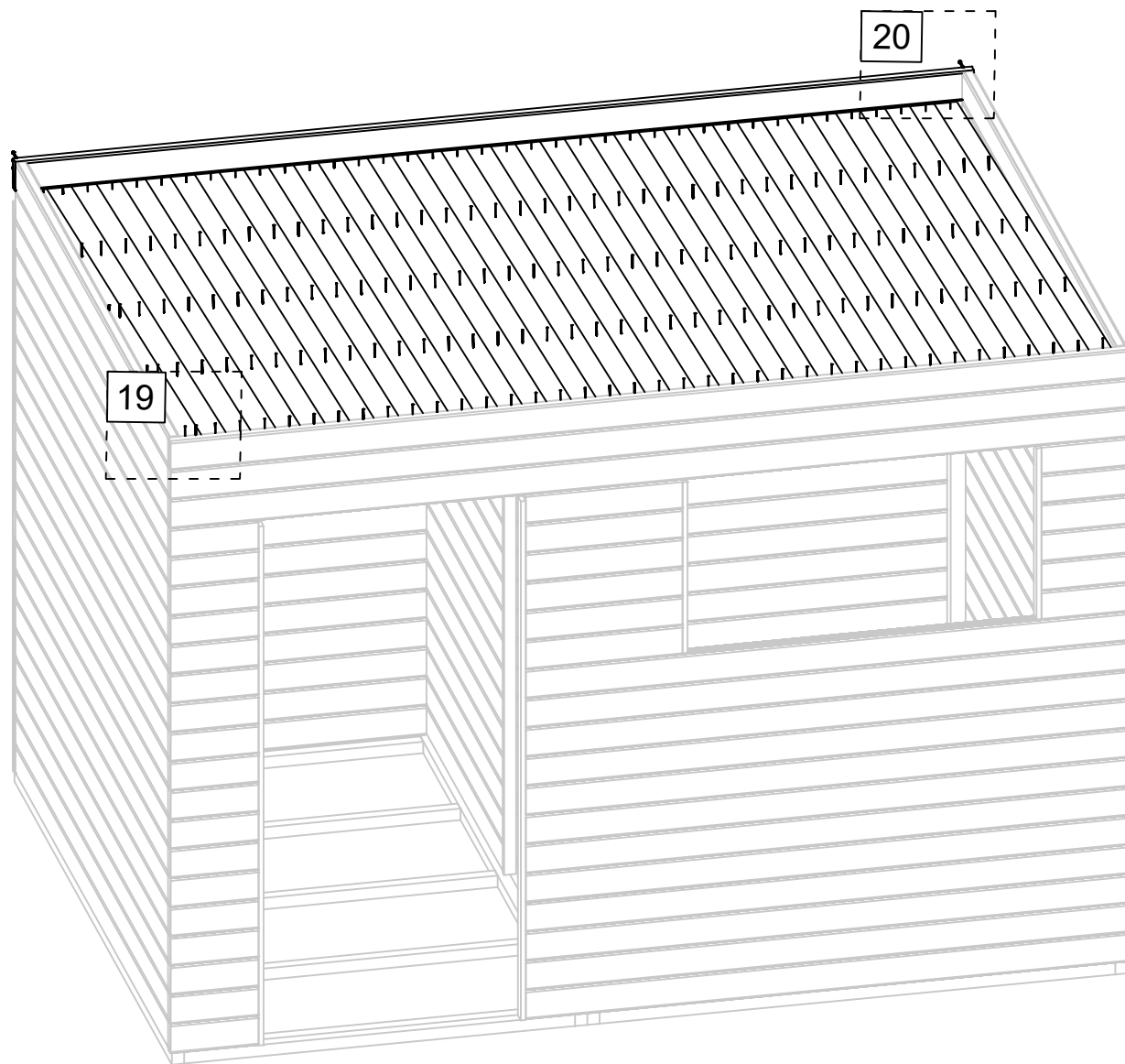

19

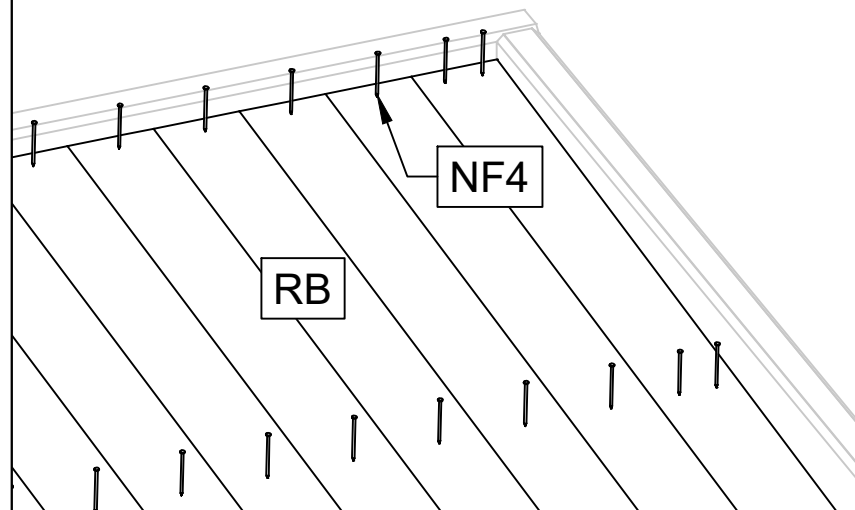

20

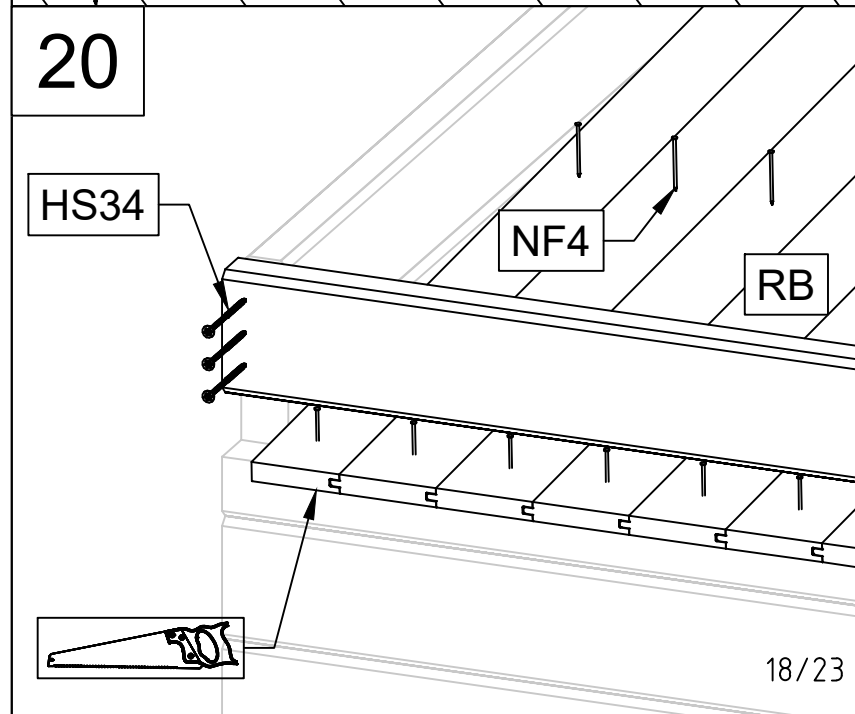

Art. Nr. 4429519

21

22

21

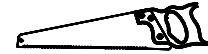

5,5

5,5

NF4

FB

22

5,5

5,5

FB

NF4

≈7,5



Art. Nr. 4429519

23

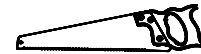

23

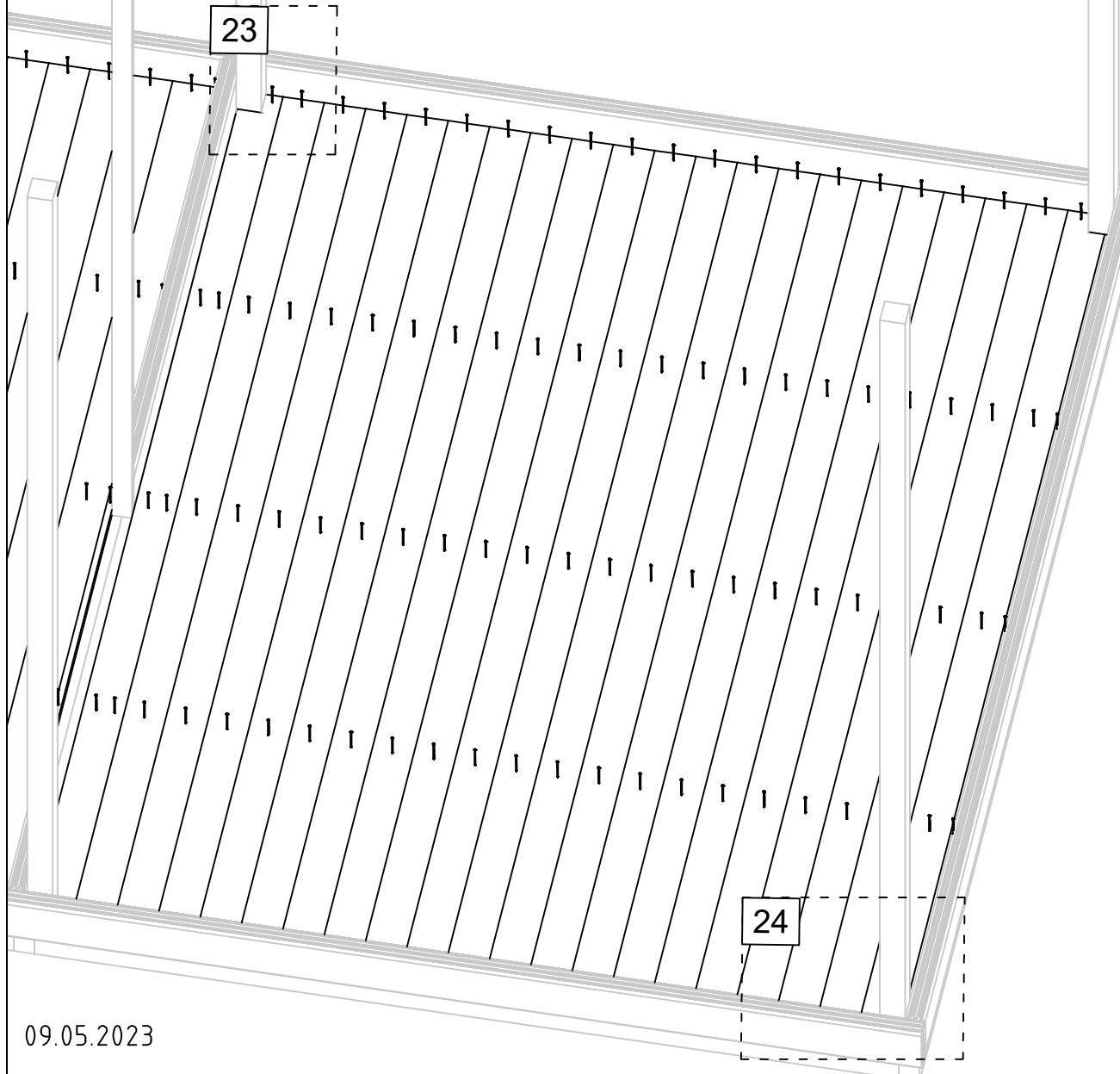

24

24

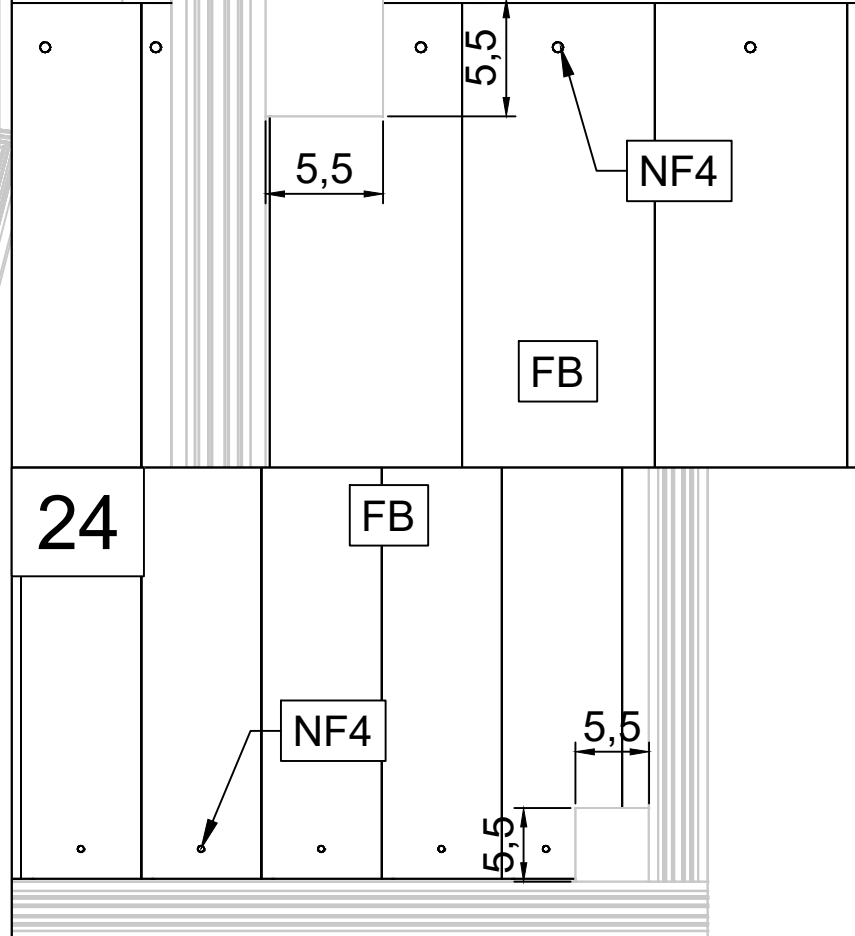

Art. Nr. 4429519

25

26

25

HS12

CF1

26

HS12

CF2

Art.-Nr. 4429519

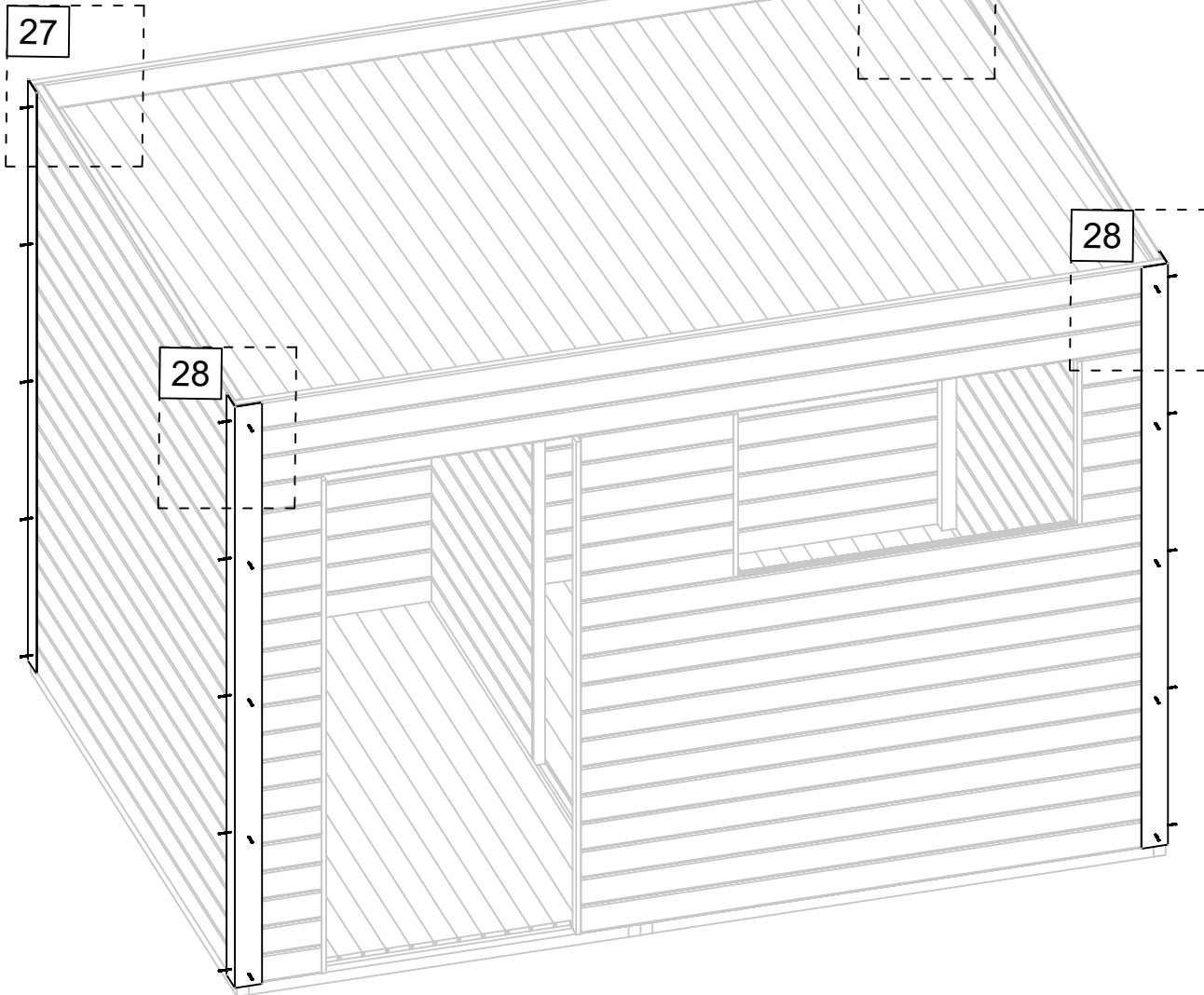

27

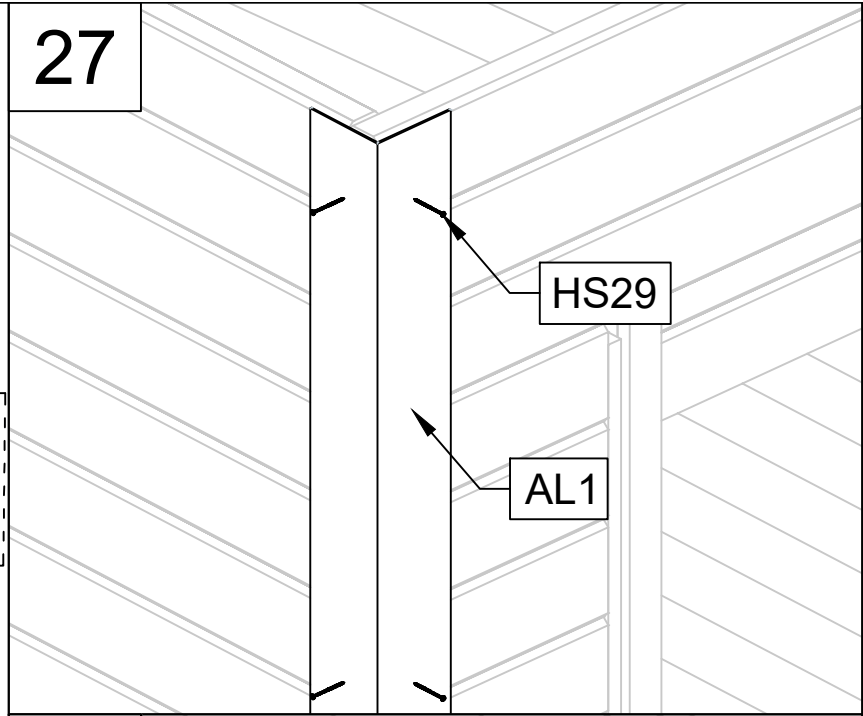

28

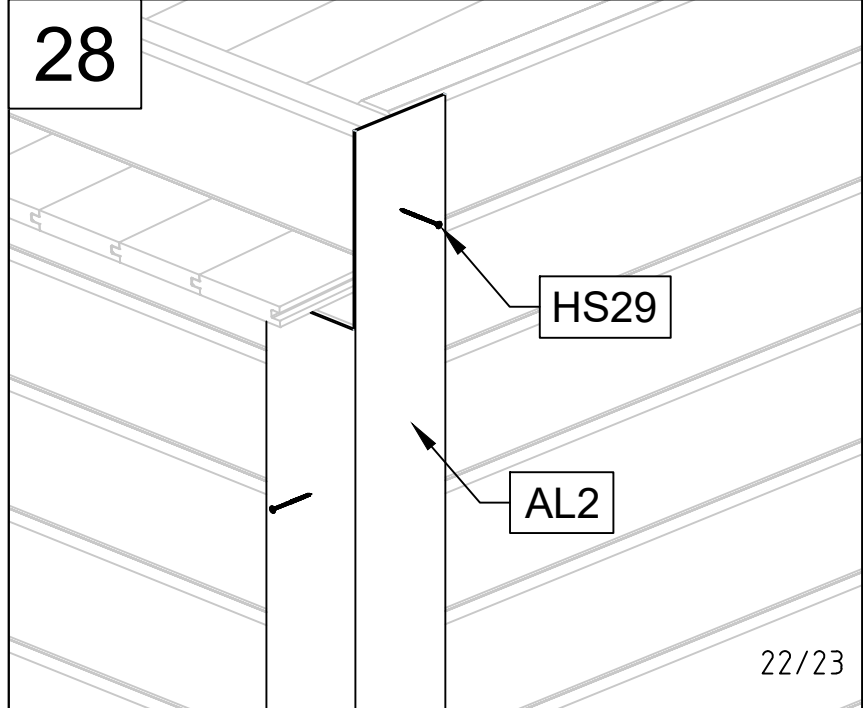

Art. Nr. 4429519

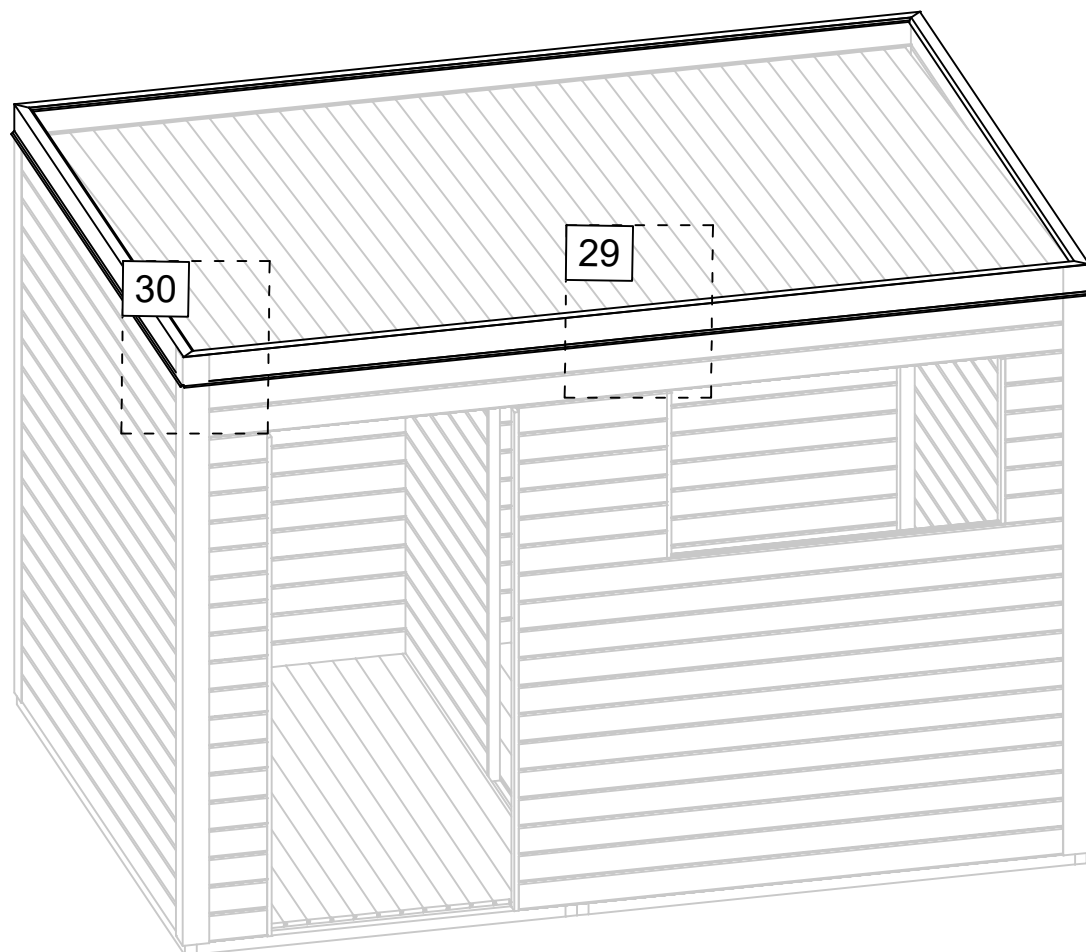



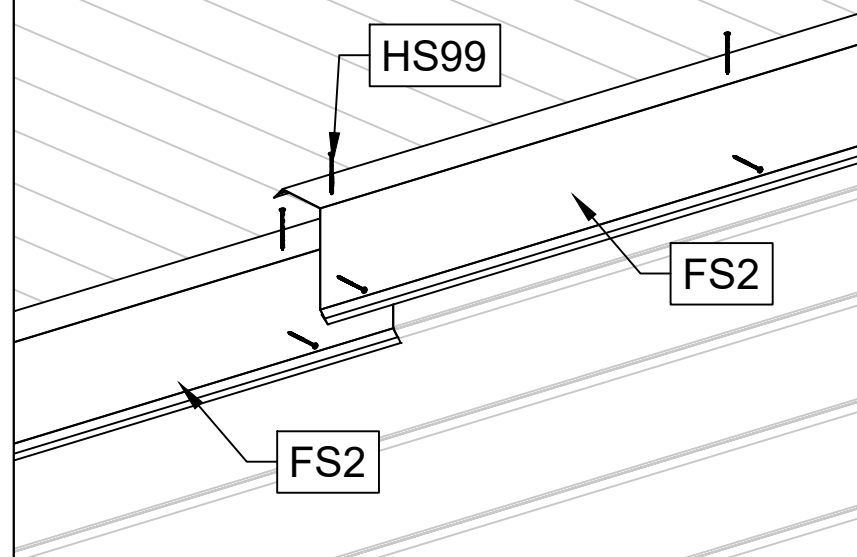

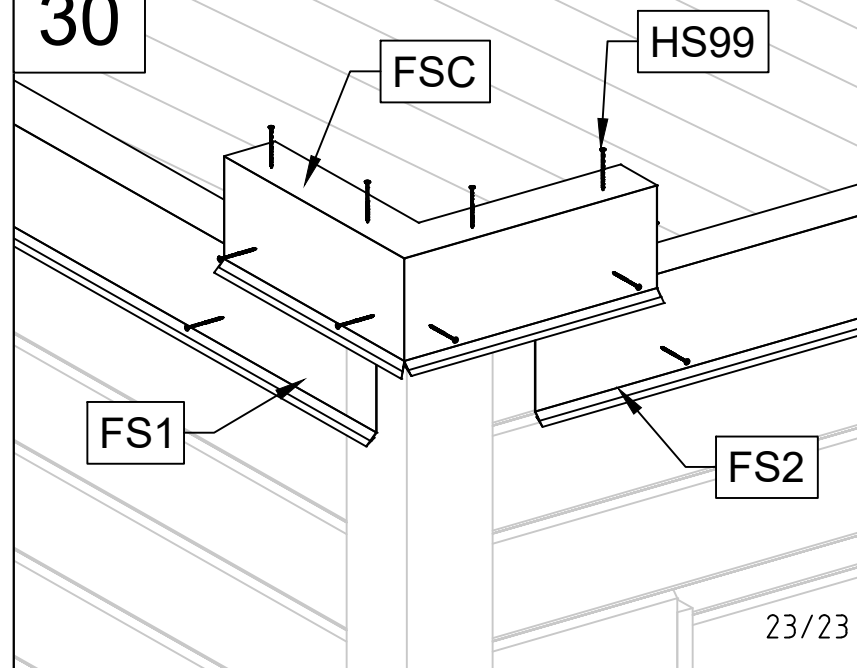

29

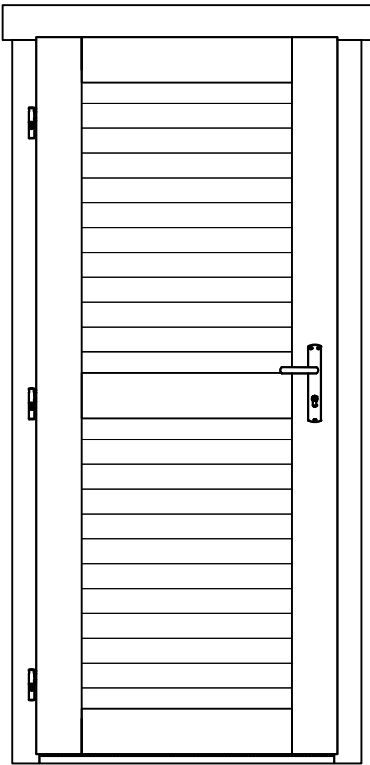
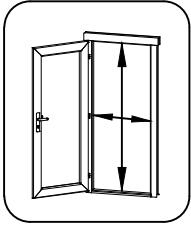

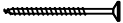
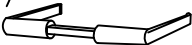
30

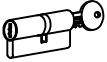

Pos	12.05.2016	Piece list - Stückliste - Liste des pièces - Elementi - Stuklijst - Tükítabel 835x1900 UL.2.100.IVV.MMd TP+	1/1	Q	P (mm)	L (mm)
		  <p>735x1818 mm</p>				
HS16	Screw for door jamb - Schraube für Türrahmen - Vis de fixation partie haute avec montants du cadre de porte - Viti x fissaggio montanti porte - Schroef voor deurkozijn - Kruvi ukse lengile		4	5x90		
HS25	Screw for doorstep - Schrauben für swelle - Vis pour fixation barre de seuil - Vite per soglia della porta - Schroef voor deurdorpel - Kruvi lävepakule		2	4.5x65		
TL4	Door handle fittings - Türgriff - Poignée de porte - Maniglie - Deurhendel / klink - Ukse käepide VU		1			
TL5	Set of door lock covers - Schlossblenden - Set de garnitures de porte - Copertura serrature - Slot sluitplaat set - Ukse lukuplaat		1			
	Cylinder lock - Zylinderschloss - Barillet de porte - Serratura - Cylinder slot - Ukse lukusüdamik		1	30x35		
	Male bolt hinge for door - Türband - Partie male de paumelle de porte - Cerniera anube x porta - Scharnier bout - Ukse polthing isane		3			