

Art. Nr. 2833400

1/8

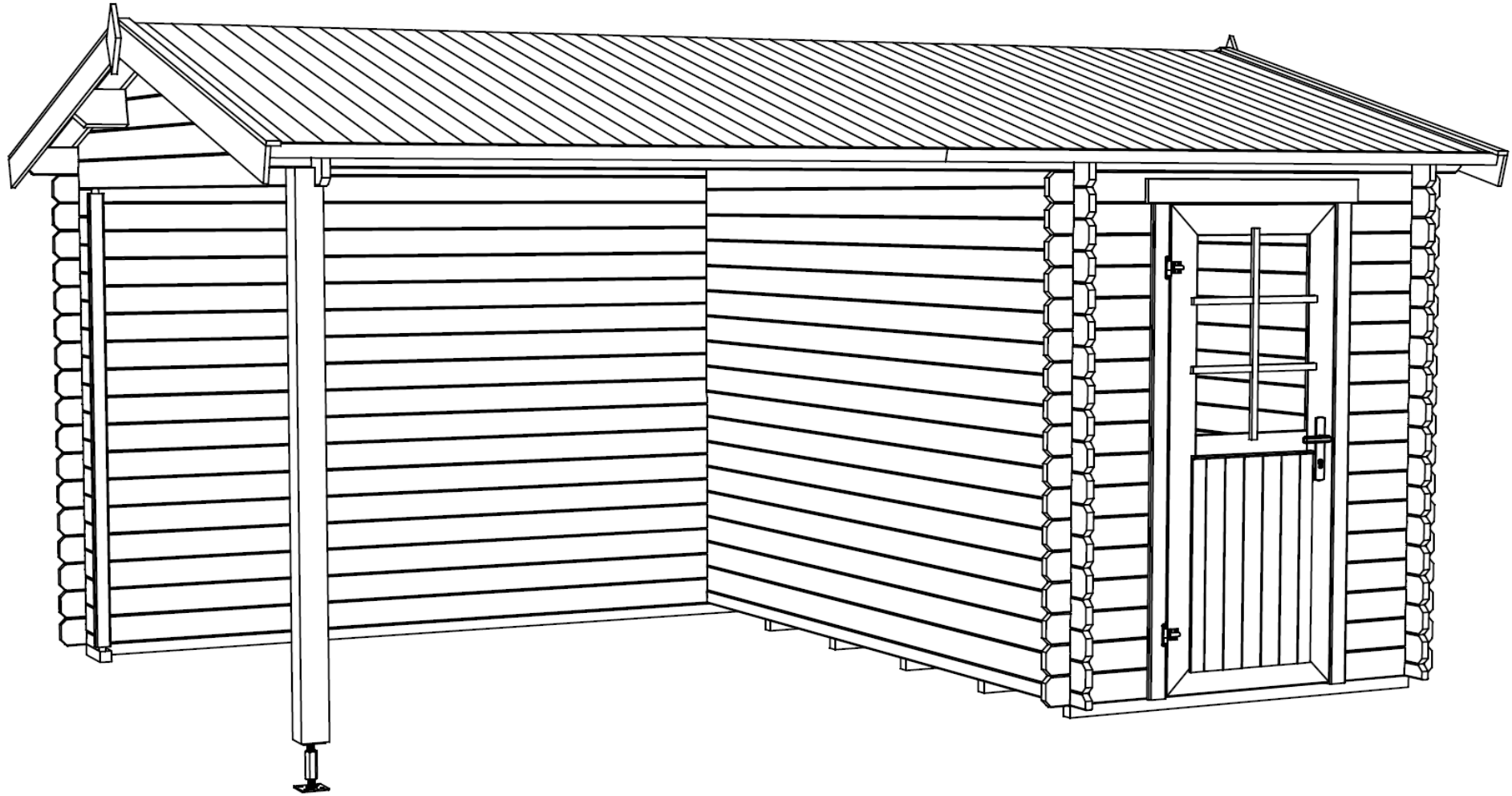

16.01.2018

Groundplan - Grundplan - Plan de masse - Planimetria - Plattegrond
- Põhiplaan

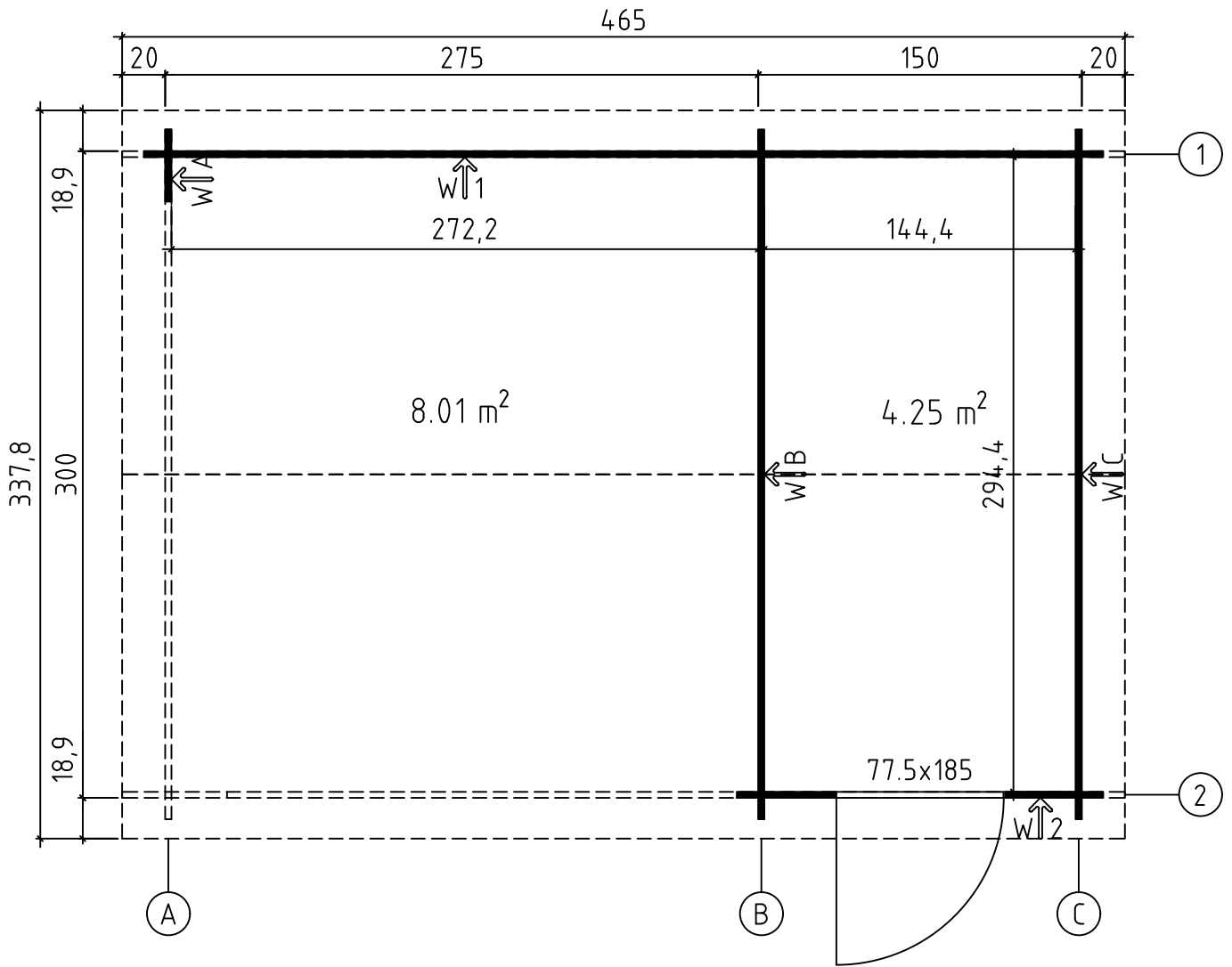

Foundation - Fundament - Fondation - Fundamenta - Fundering - Immutatud
alusraam

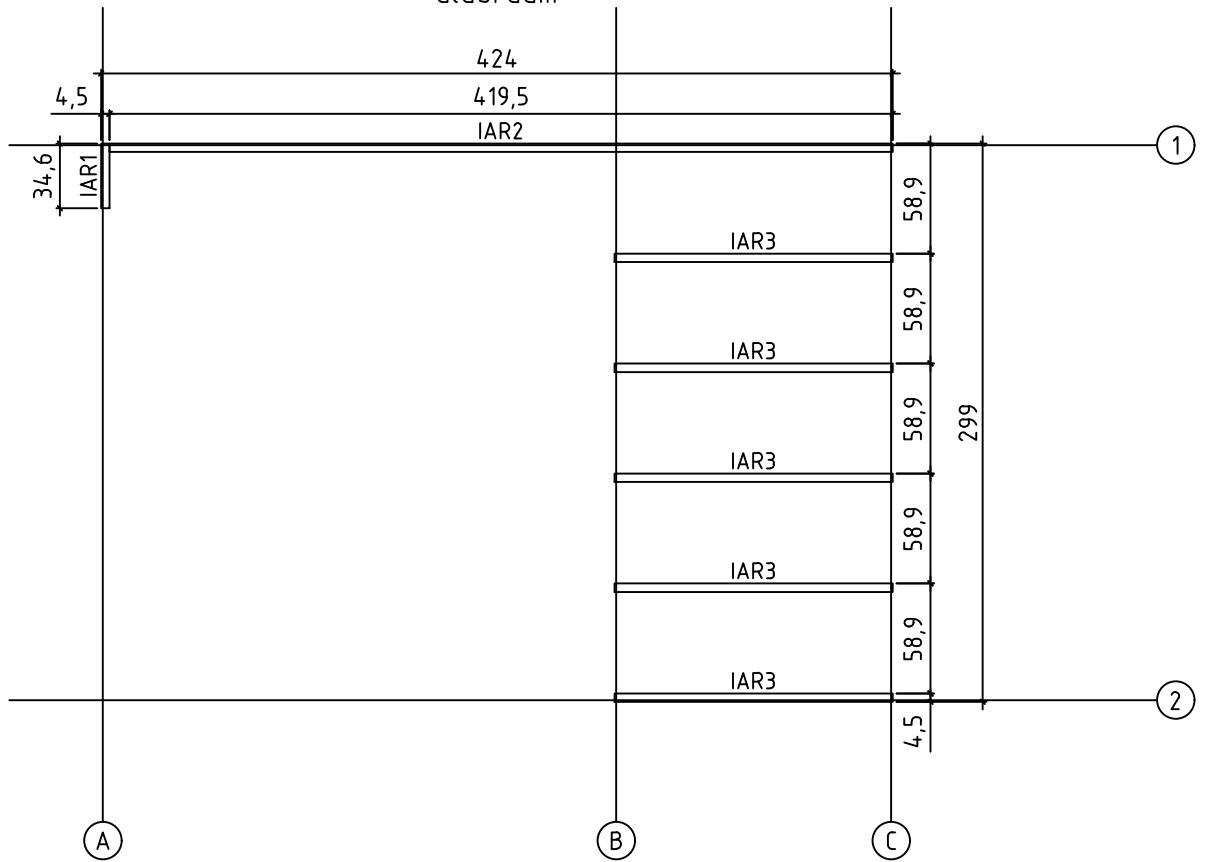



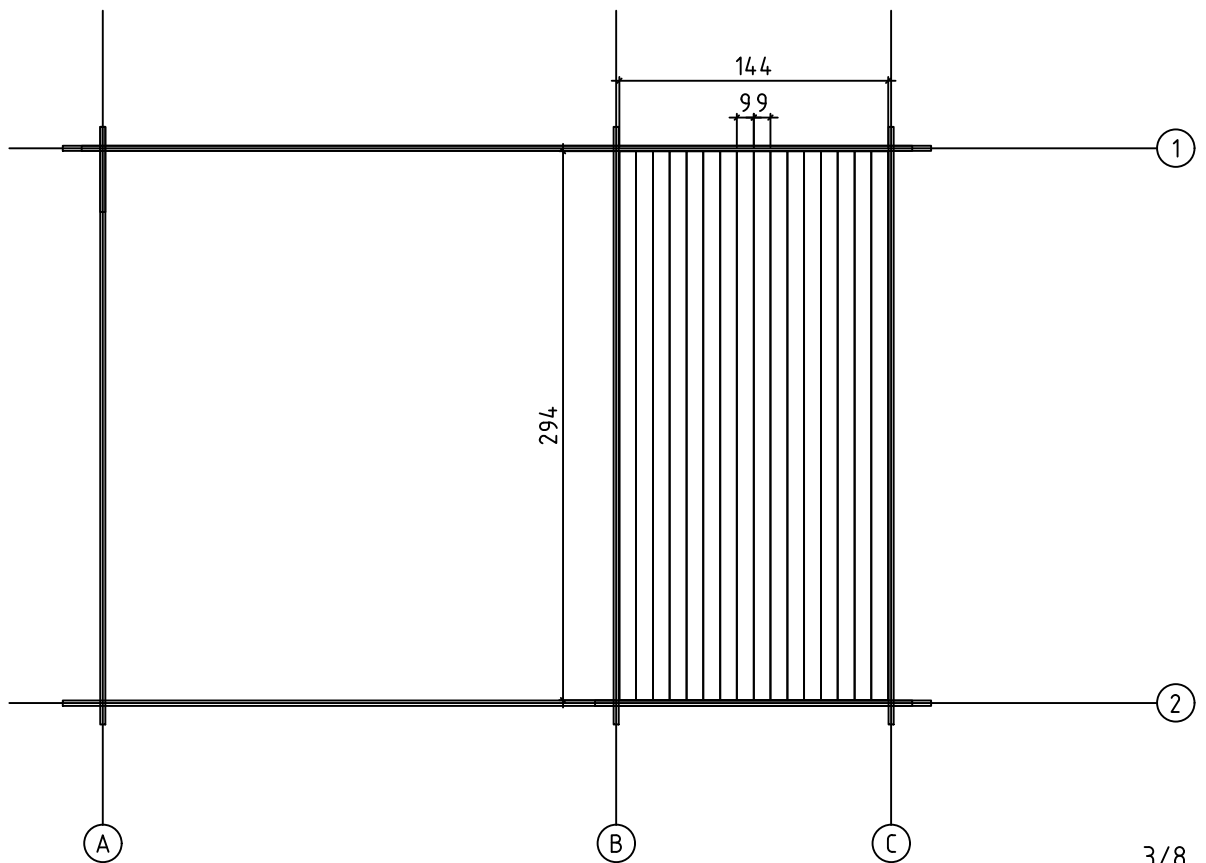

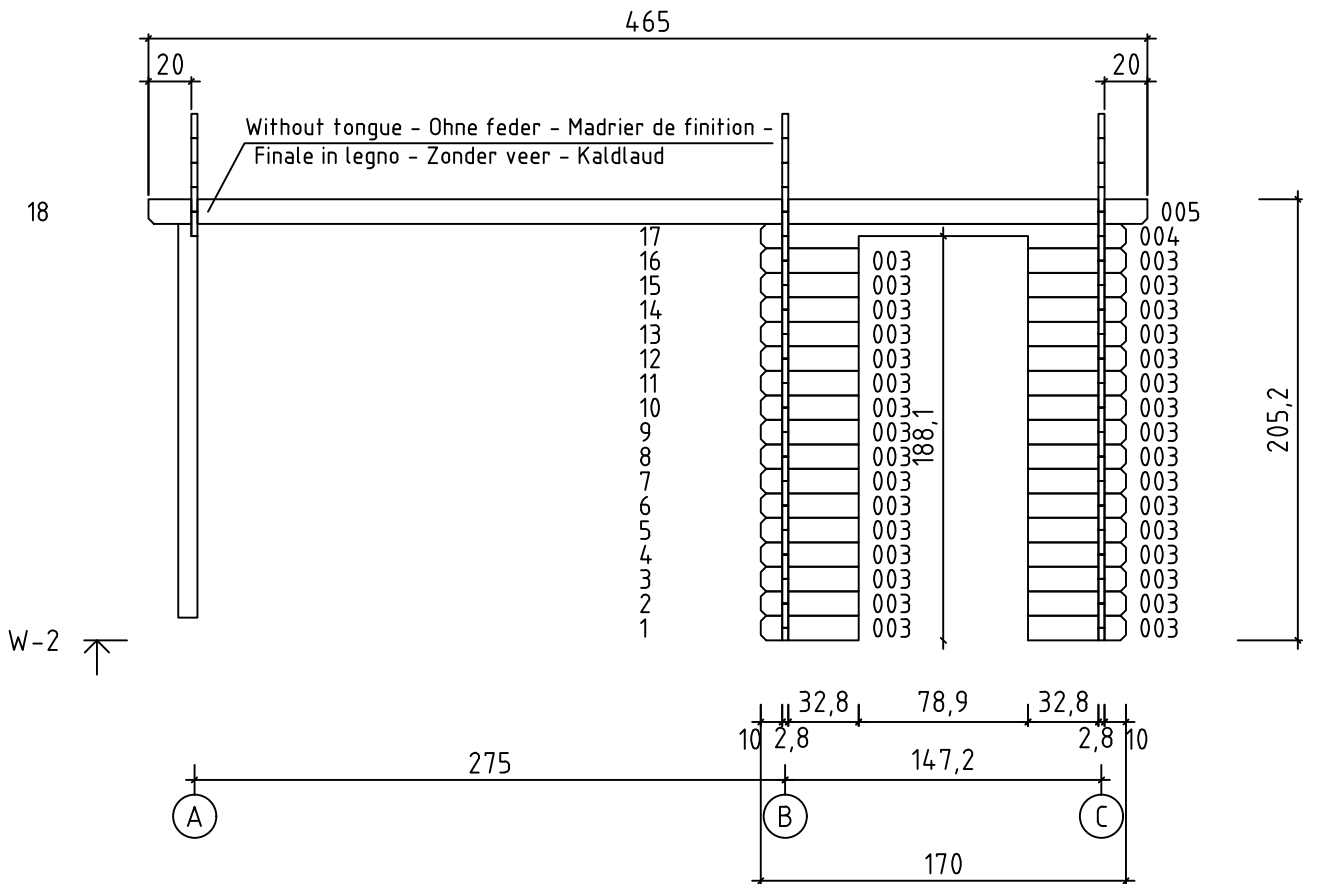
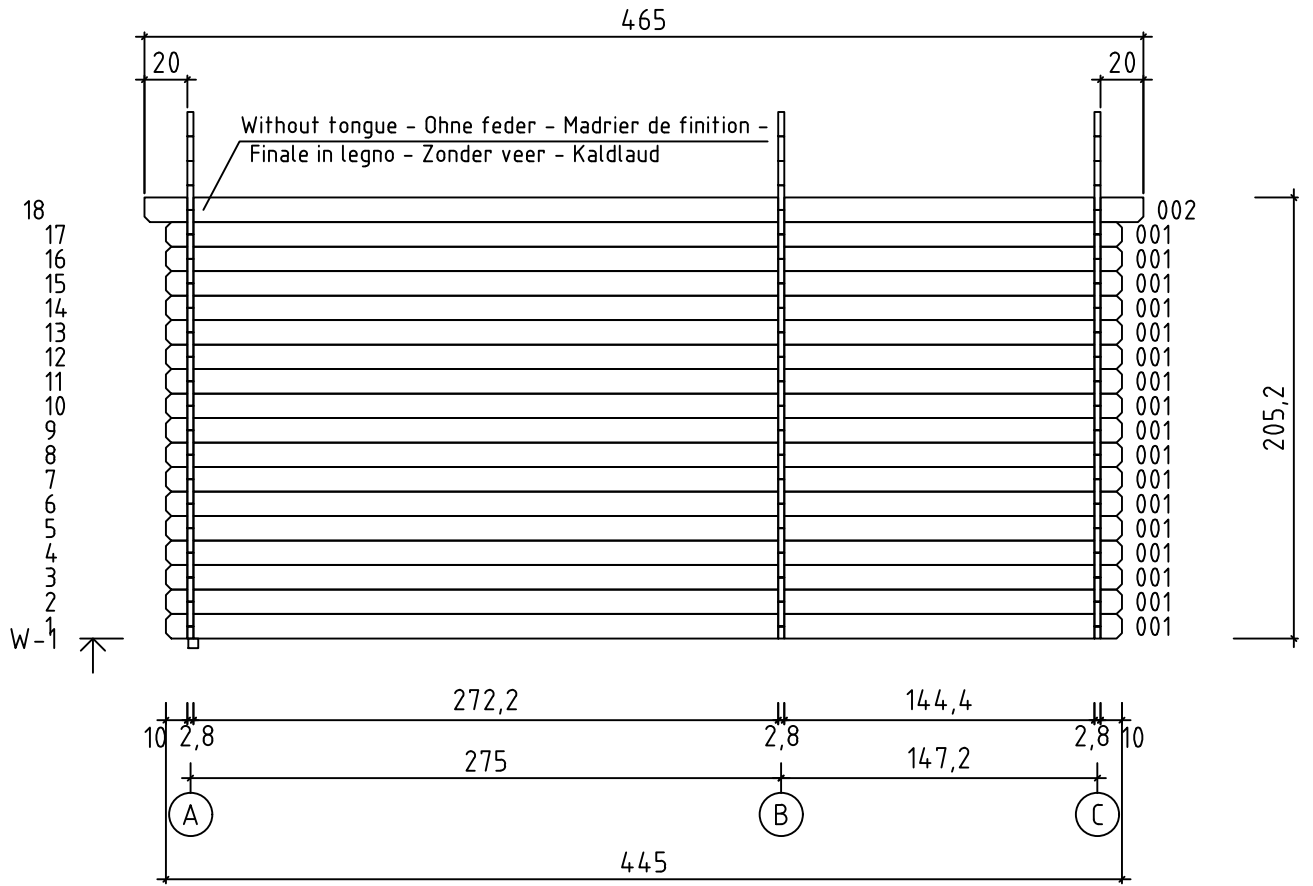



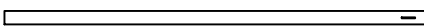

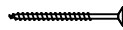
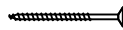

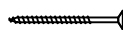
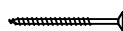
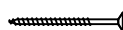
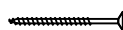
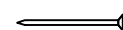

Floor boards - Fussbodenbretter - Plan pose plancher - Pavimento - Vloerhout -
Põrandalaudis

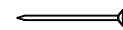
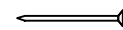
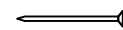

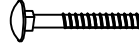

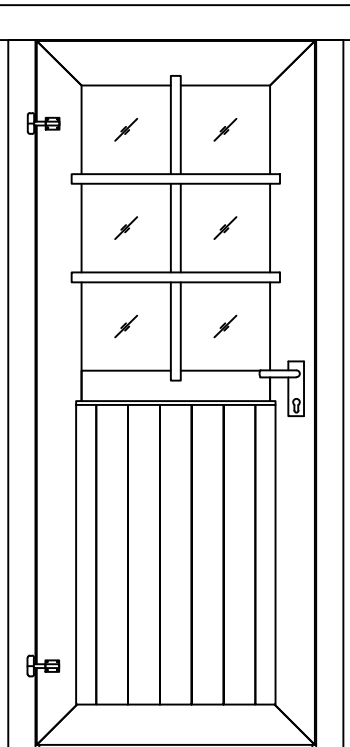
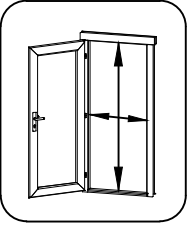
| Pos | 16.01.2018 Piece list - Stückliste - Liste des pièces - Elementi - Stuklijst - Tükítabel Art.Nr. 2833400 6/8 | Q | P (mm) | L (mm) |
|-------|---|-----|-----------|-----------|
| 001 | | 17 | 28x114 | 4450 |
| 002 | | 1 | 28x120 | 4650 |
| 003 | | 48 | 28x114 | 456 |
| 004 | | 1 | 28x114 | 1700 |
| 005 | | 1 | 28x120 | 4650 |
| 006 | | 1 | 28x57 | 456 |
| 007 | | 35 | 28x114 | 3200 |
| 012 | | 2 | 28x57 | 3200 |
| WA-1 | | 1 | | |
| WB-1 | | 1 | | |
| WC-1 | | 1 | | |
| IAR2 | Foundation - Fundament - Fondation - Fondamenta - Fundering - Immutatud alusraam | 1 | 45x45 | 4195 |
| IAR3 | Foundation - Fundament - Fondation - Fondamenta - Fundering - Immutatud alusraam | 5 | 45x45 | 1490 |
| IAR1 | Foundation - Fundament - Fondation - Fondamenta - Fundering - Immutatud alusraam | 2 | 45x45 | 346 |
| A-PR1 | Roof beam - Dachbalken - Panne de toit - Perlina del tetto - Gordingen / dakbalk - Pärilin | 3 | 44x140 | 4650 |
| | Floor boards - Fussbodenbretter - Lamé de plancher - Pavimento - Vloerhout - Põrandalaud | 17 | 90x15 | 2940 |
| | Roof boards - Dachbretter - Voliges - Perlina per tetto - Dakhout - Katuselaud | 104 | 90x15 | 1750 |
| | Floor fillet - Fussbodenleiste - Corniere de finition du plancher - Finitura per pavimento (battisco pa) - Vloerafwerklijst - Põrandaliist | | 18x18 | 8.94 |
| | Roofing felt fillet - Dachpappenleiste - Baguette de fixation du feutre bitumeux - Asse per fissaggio guaina bituminosa - Afdekljst asfaltpapier - Katusepapiiist | 4 | 15x45 | 1800 |
| | Post - Pfosten - Poteau - Piede registrabile - Stijl - Post | 1 | 90x90 | 1835 |

| Pos | 16.01.2018 Piece list - Stückliste - Liste des pièces - Elementi - Stuklijst - Tükítabel Art.Nr. 2833400 7/8 | Q | P (mm) | L (mm) |
|-------|--|-----|-----------|-----------|
| TB-1 | Fascia board - Traufbrett - Bandeau de toit - Finitura lati tetto - Gevellijst - Räästalaud  | 4 | 15x45 | 2325 |
| KFS-1 | Storm protection - Sturmleiste - Latte anti-tempete - Protezione anti vento - Stormverankering / beveiliging - Tormikinnitusliist  | 5 | 22x45 | 2050 |
| | U-profile - U-profiils - Profile u - Profilo ad u - U-profiel - U-profiil  | 1 | 28x58 | 1850 |
| | Gable moulding - Giebelleiste - Planche de rive - Finitura per frontale e retro del tetto - Gevellijst - Viilulaud  | 4 | 15x120 | 1800 |
| HS8 | Screw for gable segment - Schrauben für deckblatt - Vis pour fixation losange de finition - Viti x frontali tetto - Schroef voor gevelpunt segment - Kruvi rombile  | 4 | 3.5x35 | |
| HS9 | Screw for u-profile - Schraube zur befestigung u-profiils - Vis a tete fraisée pour profil u - Vite per profilo ad u - Schroef ter bevestiging u-profiel - Kruvi U-profiilile  | 6 | 3.5x50 | |
| HS9 | Screw for gable moulding - Schrauben für giebelleiste - Vis pour fixation planche de rive - Vite per fissare finiture davanti e dietro del tetto - Schroef voor gevellijst - Kruvi viilulauale  | 24 | 3.5x50 | |
| HS4 | Screw for fascia boards - Schrauben für traufbretter - Vis pour fixation bandeau de toit - Viti x striscia del tetto - Schroef voor gevellijst - Kruvi räästalauale  | 22 | 3x30 | |
| HS14 | Screw for post - Schrauben für pfosten - Vis de fixation des poteaux - Viti per inviare - Schroef voor stijlen - Kruvi postile  | 2 | 4.5x80 | |
| HS18 | Screw for roof beams - Schrauben für dachbalken - Vis pour fixation pannes de toit - Viti per perline del tetto - Schroef voor gordingen / dakbalken - Kruvi pärlinitele  | 9 | 5x120 | |
| HS18 | Screw for gable - Schrauben für giebel - Vis pour fixation des pignons - Viti per timpano - Schroef voor gevelpunt - Kruvi viilude kinnitamiseks  | 6 | 5x120 | |
| HS16 | Screw for 1. wall beam - Schraube für 1. bohlenreihe - Vis de fixations 1ere rangée de madriers avec poutrelles de fondations - Vite fissaggio alle fondamenta - Schroef voor 1 wandbalk - Kruvi poollauale  | 6 | 5x90 | |
| HS16 | Screw for foundation - Schrauben zur befestigung fundament - Vis de fixations des poutrelles de fondations - Viti x fondamenta - Schroef voor fundering - Kruvi alusraamile  | 1 | 5x90 | |
| HS20 | Screw for post height adjustment - Schrauben für regulierungsschraube für pfosten - Vis de fixation de support réglable de poteau - Viti per fissare ed aggiustare l'altezza del palo verticale - Schroef voor hoogte instelling stijlen - Kruvi vajumispooldile  | 8 | 6x50 | |
| NF2 | Zn nail for floor fillet - Zn nagel für fussbodenleiste - Pointe pour corniere de finition du plancher - Chiodi x fissaggio pavimento - Spijker(nagel) voor vloer afdeklijst - Nael põrandaliistule  | 18 | 1.4x40 | |
| SH28 | Hammer block - Schlagholz - Calle de frappe - Blocco di legno da usare come cuscinetto quando si usa il martello - Slagklos - Löögiklots  | 1 | | |
| SFS | Nut for storm protection - Schraubenmutter für sturmleiste - Erou pour latte anti-tempete - Dado x asta protezione vento - Moer voor stormverankering - Mutter tormikinnitusliistule  | 10 | D6 | |
| NF4 | Zn nail for roof - Zn nagel für dachbretter - Pointe pour fixation voliges de toit - Chiodi x perline tetto - Spijker(nagel) voor dakhout - Nael katuselauale  | 326 | 2x50 | |
| NF4 | Zn nail for floor - Zn nagel für fussbodenbretter - Clous pour plancher - Chiodi x perline pavimento - Spijker(nagel) voor vloer - Nael põrandalauale  | 108 | 2x50 | |
| NF5 | Zn nail for roofing felt fillet - Zn nagel für dachpappenleiste - Pointe pour baguette de fixation feutre bitumeux - Chiodi x carta bituminosa x tetto - Spijker(nagel) voor asfaltpapier afdeklijst - Papiliistunael  | 20 | 2x40 | |
| GS | Gable segment - Deckblatt - Losange de finition - Decorazione in legno x frontale tetto - Gevelpunt segment - Romb  | 2 | | |
| DFS | Washer for storm protection - Dichtscheibe für sturmleiste - Rondelle pour latte anti-tempete - Rondella x asta protezione vento - Afdichtring voor storm strip - Seib tormikinnitusliistule  | 10 | D6 | |
| BFS | Bolt for storm protection - Bolzen für sturmleiste - Boulon pour latte anti-tempete - Bullone x asta protezione vento - Bout voor stormankerlat - Puidupolt tormikinnitusliistule  | 10 | 6x60 | |

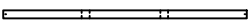
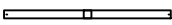
| Pos | 16.01.2018 | Piece list - Stückliste - Liste des pièces - Elementi - Stuklijst - Tükitalabel 775x1850 UK.2.056.XVV.MMX28 XGA+28 | 1/2 | Q | P (mm) | L (mm) |
|-----|--|---|-----|--------|-----------|-----------|
| | | Glass size - Glasgröße - Taille de la vitre - Misura del vetro - Glas afmeting - Klaasi mõõt: 502x750 mm | | | | |
| | |   <p>702x1793 mm</p> | | | | |
| 1 | Upper door jamb - Türrahmen oben - Cadre de porte supérieur - Telaio superiore della porta - Bovendorpel - Ukse ülemine leng |  | 1 | 66x100 | 722 | |
| 2 | Left door jamb - Türrahmen links - Cadre de porte gauche - Telaio montante sinistro della porta - Linkerstijl deurframe - Ukse vasak leng |  | 1 | 66x80 | 1850 | |
| 3 | Right door jamb - Türrahmen rechts - Cadre de porte droit - Telaio montante destro della porta - Rechterstijl deurframe - Ukse parem leng |  | 1 | 66x80 | 1850 | |
| 4 | Doorstep - Swelle - Barre de seuil - Soglia della porta - Deurdorpel - Lävepak |  | 1 | 20x21 | 702 | |
| 5 | Georgian bars - Sprossen - Croisillons - La griglia georgiana - Raamverdeling - Petteliistud |  | 1 | 15x25 | 784 | |
| 6 | Georgian bars - Sprossen - Croisillons - La griglia georgiana - Raamverdeling - Petteliistud |  | 2 | 15x25 | 536 | |

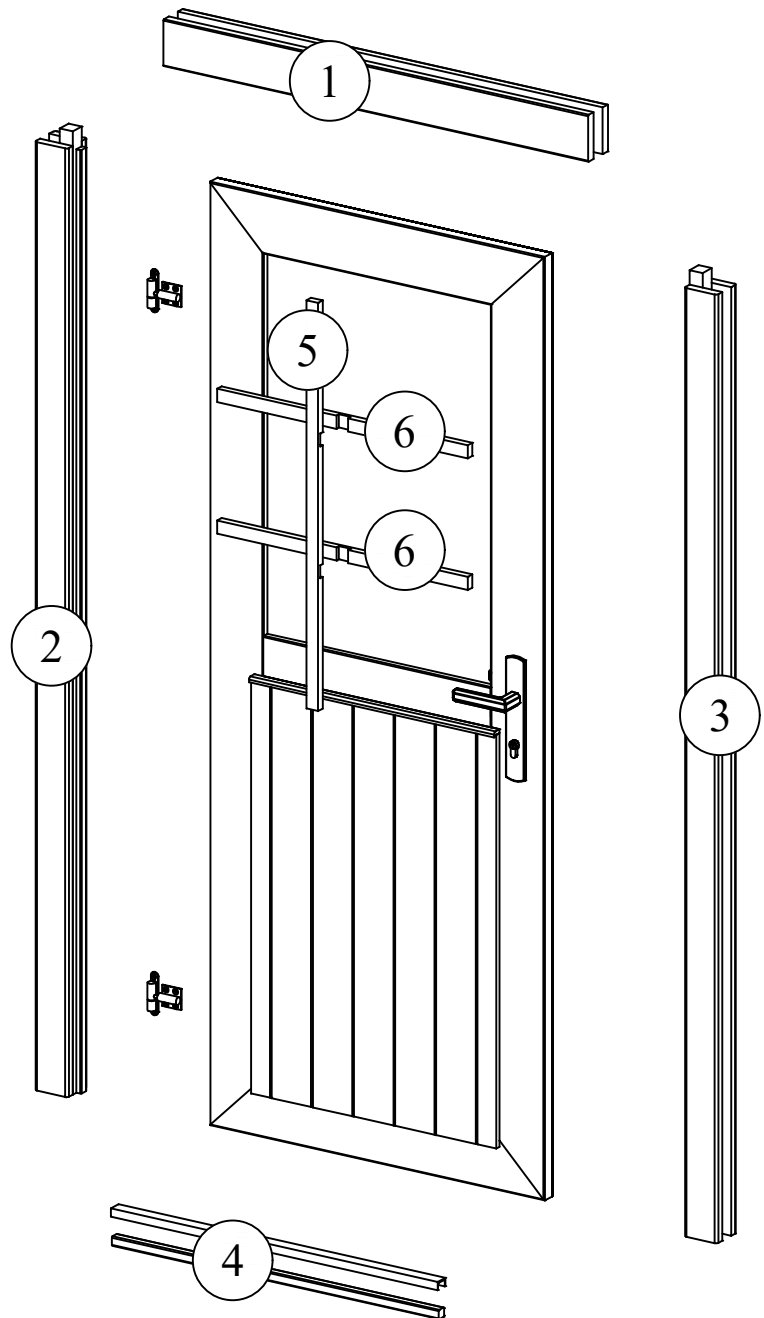

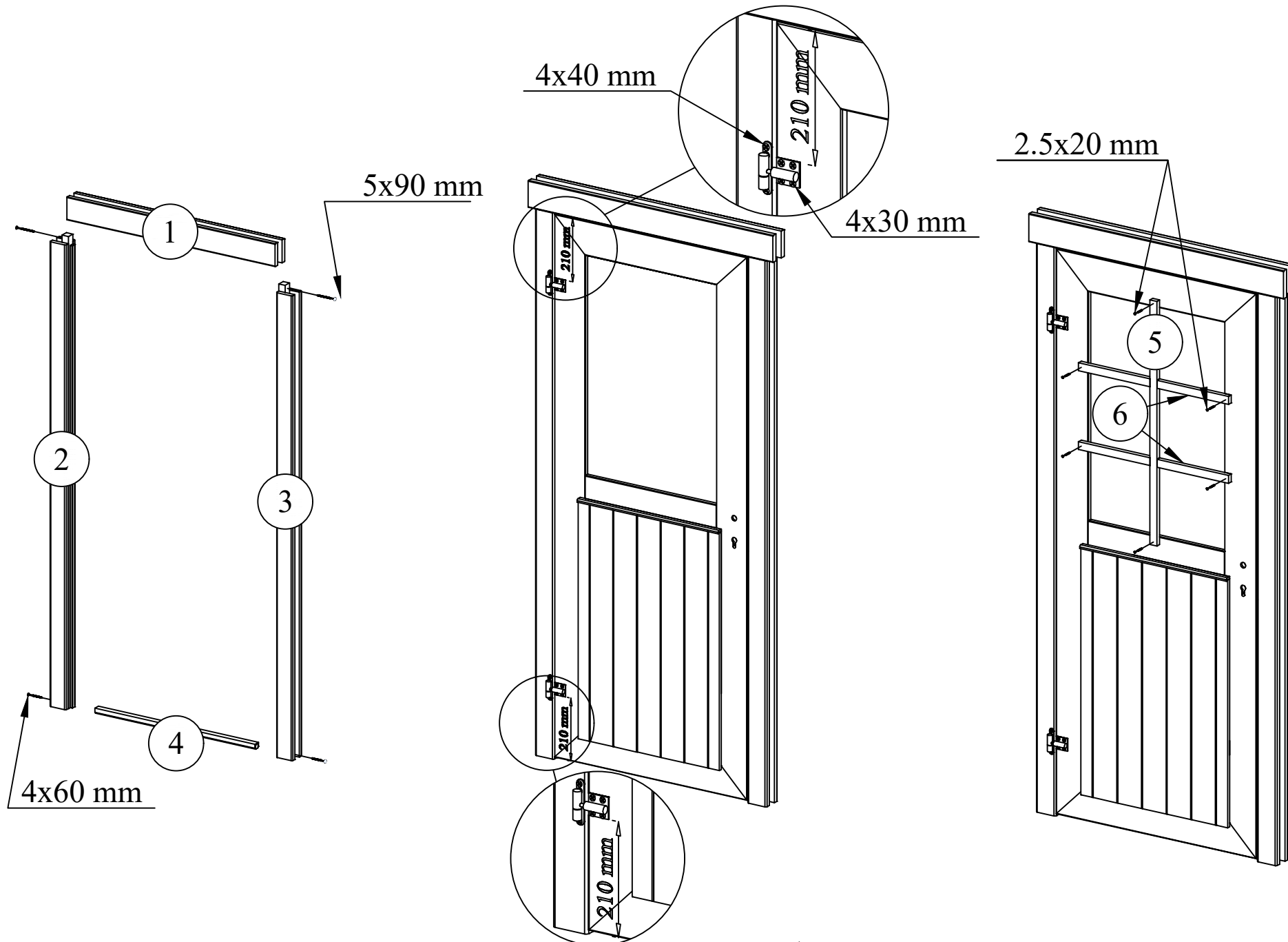

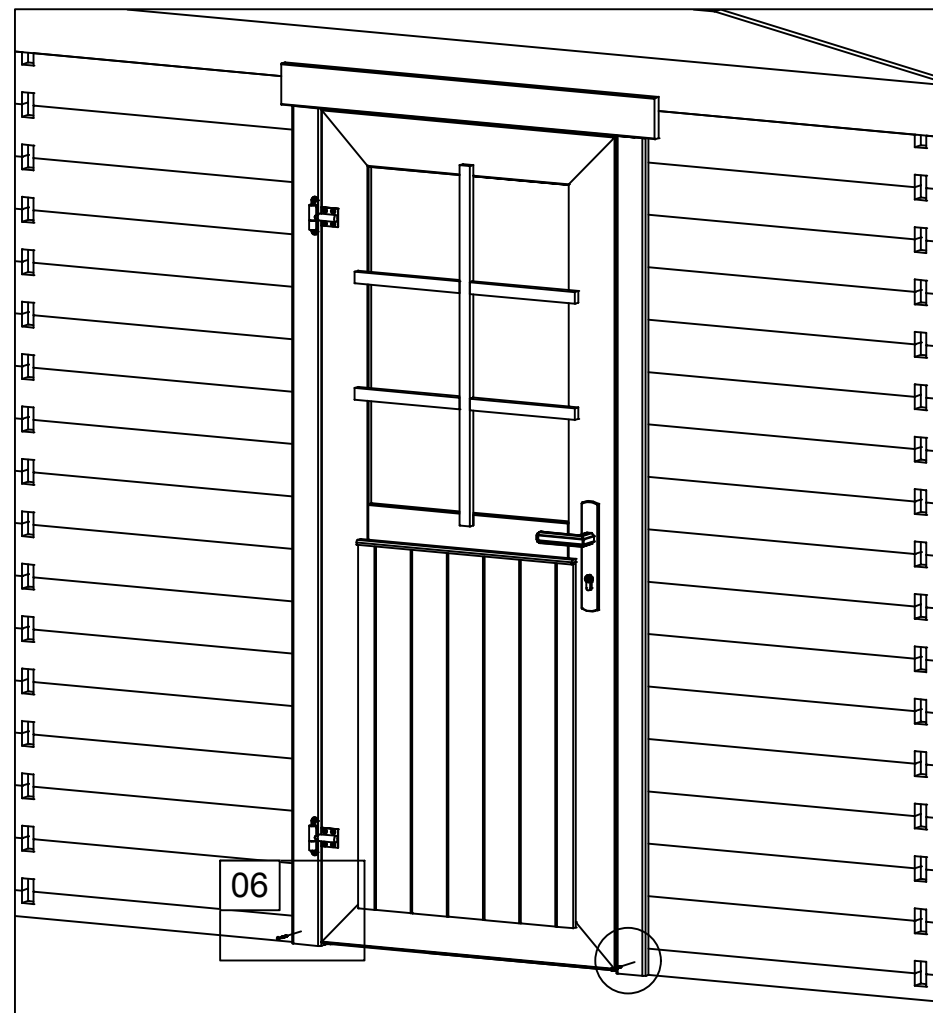

01

4x25 mm

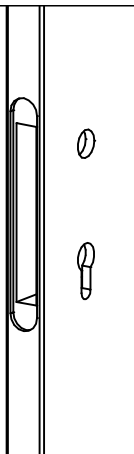
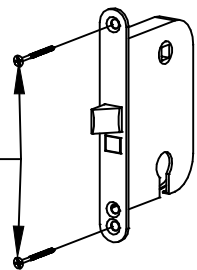

04

4x25 mm

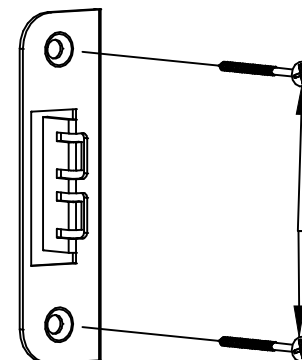

02

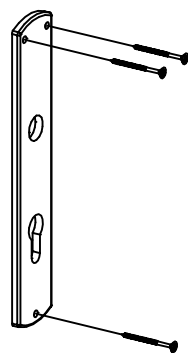
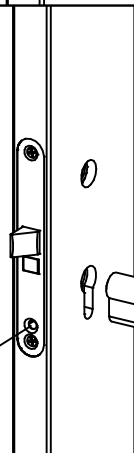
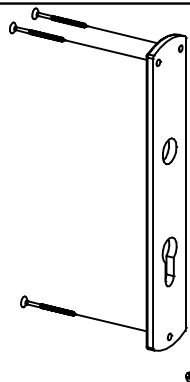

05

4.5x60 mm

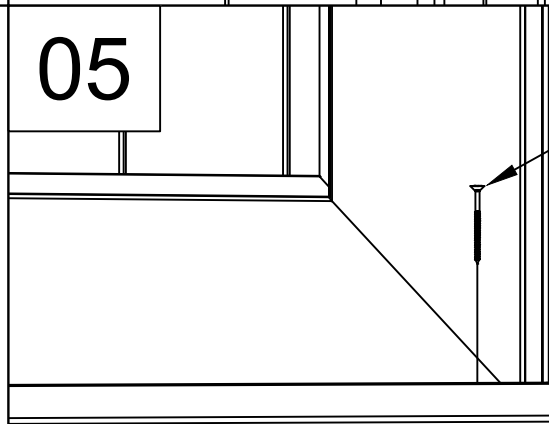

03

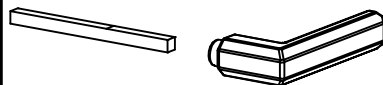
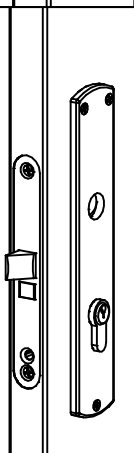
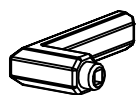

06

3.5x50 mm

