

Caroline 2
Art. Nr. 9904500
1/5

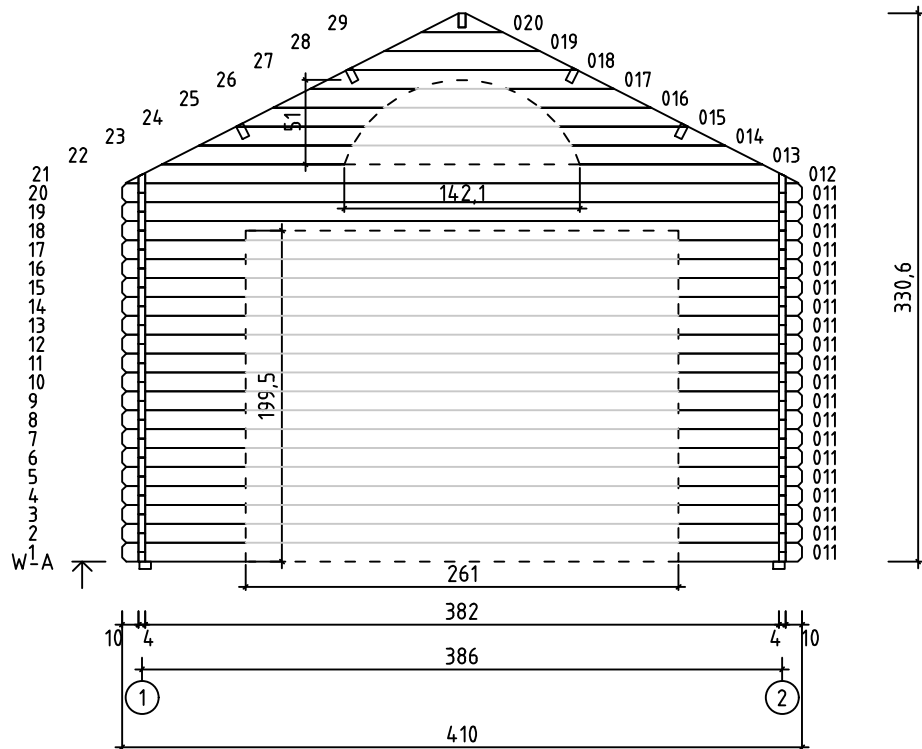

15.02.2021

Art. Nr. 9904500

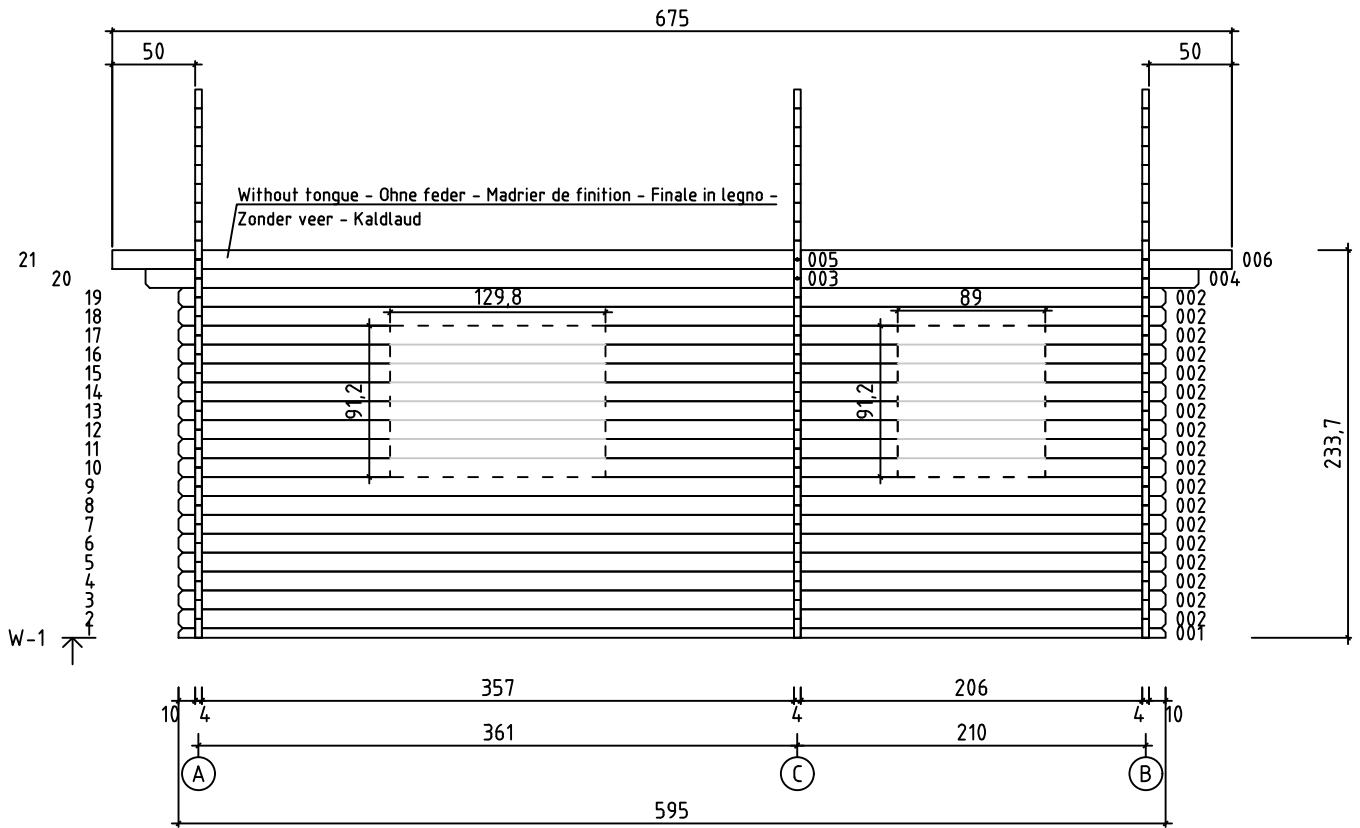

Art. Nr. 9904500

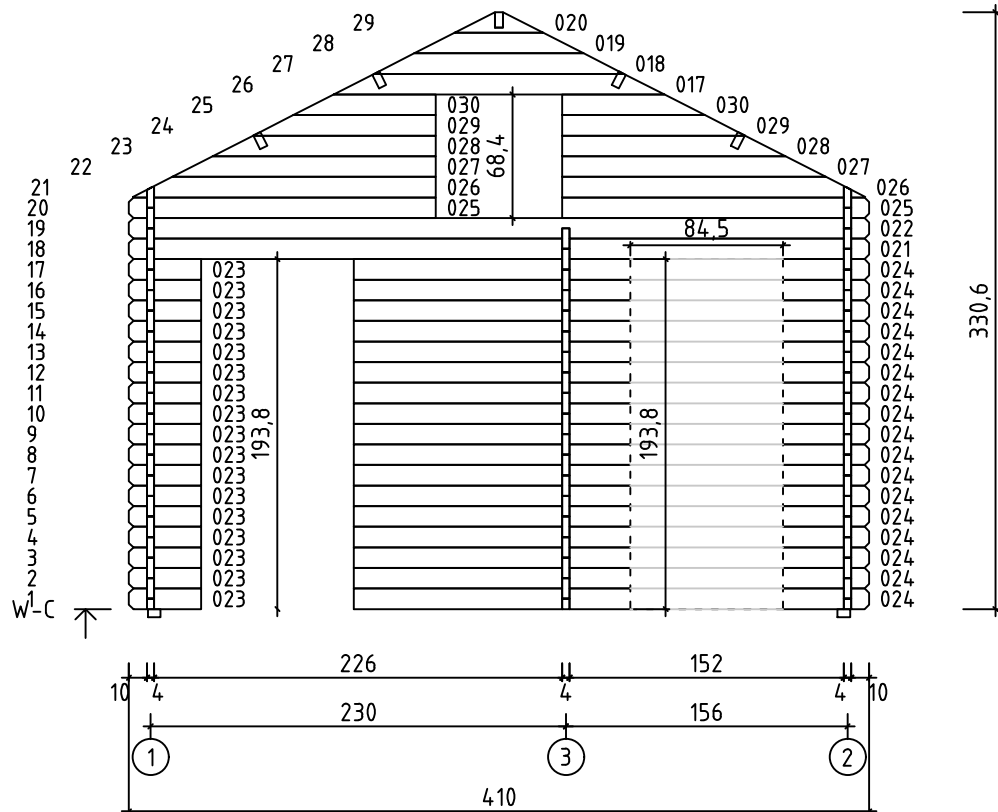
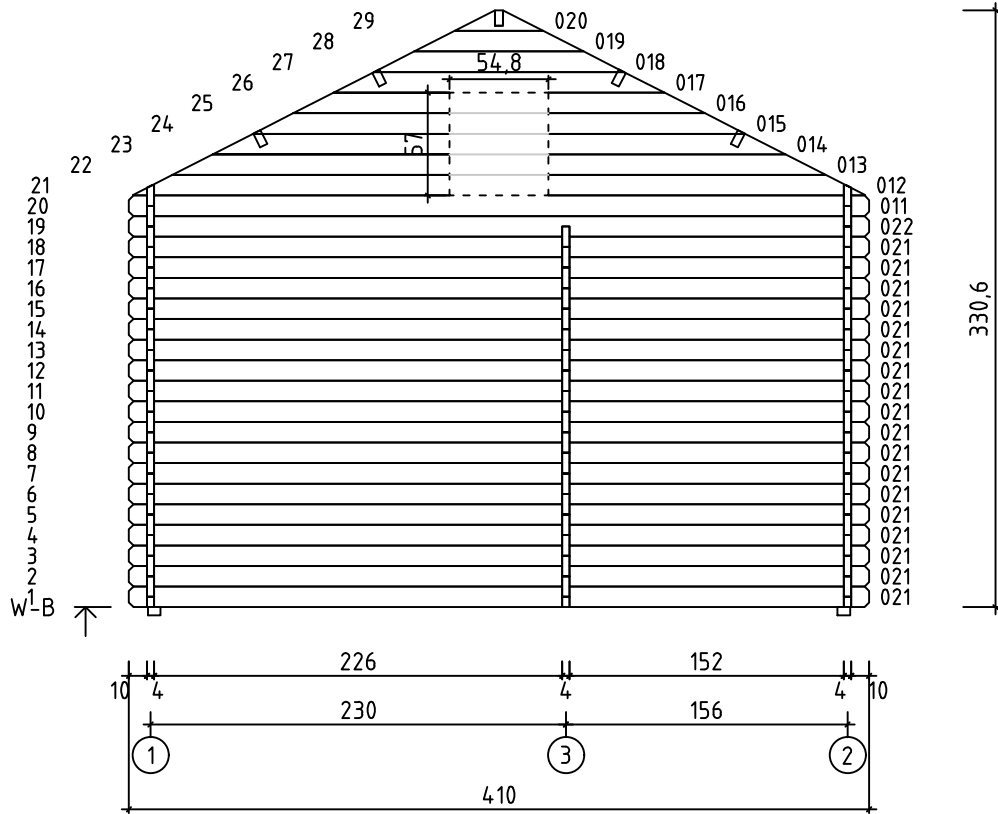

Art. Nr. 9904500

You can choose the location of the doors and windows by cutting the wall logs as shown in the pictures (see the dotted line).

Dafür sind aber werksseitig keine aussparungen vorgesehen so dass sie sowohl Fenster als auch Tür individuell verbauen können. eine anleitung hierfür entnehmen sie bitte der Montageanleitung (siehe bild).

Vous pouvez choisir l'emplacement des portes et des fenêtres en coupant les madriers du mur comme indiqué sur les images (voir les lignes pointillées).

Possibilità di scegliere dove posizionare le porte e le pareti secondo l'immagine (linee tratteggiate)

U kunt de locatie van de deuren en ramen kiezen door de muurblokken er uit te zagen, zoals in de afbeeldingen staat weergegeven (zie de stippellijnen)

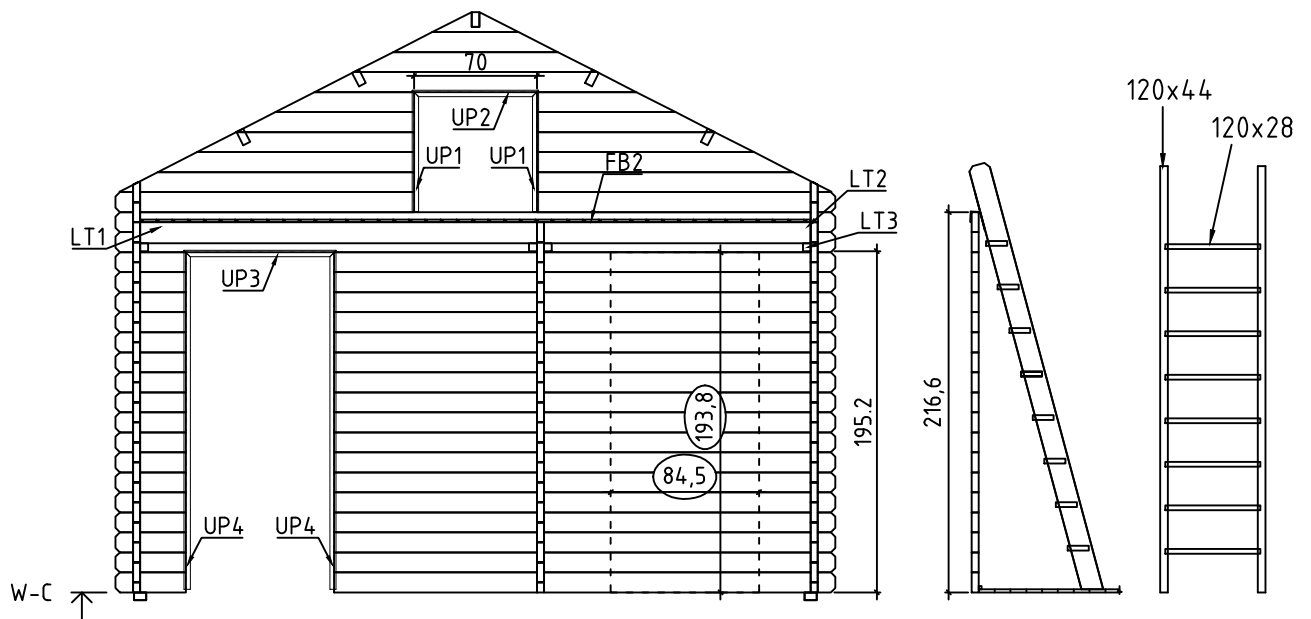

Uste ja akende asukoht on võimalik ise valida. Avatäited tuleb lõigata joonistel näidatud mõõtudes (vaadake punktiiriooni).



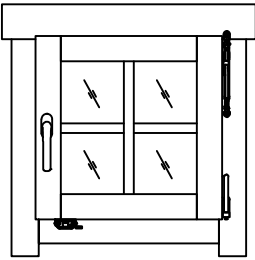
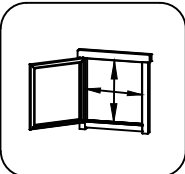
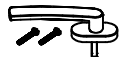
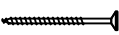

120x44 L=2520 mm 2 tk

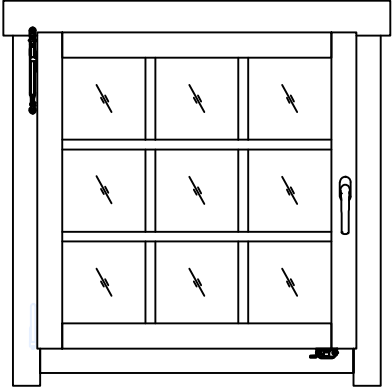
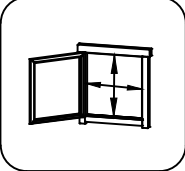
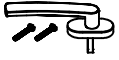
120x28 L=542 mm 8 tk

Pos	11.11.2018 Piece list - Stückliste - Liste des pièces - Elementi - Stuklijst - Tükítabel 540x540 AK.1.104.TPSP.d DGP+	1/1	Q	P (mm)	L (mm)
	<p data-bbox="261 152 1283 183">Glass size - Glasgröße - Taille de la vitre - Misura del vetro - Glas afmeting - Klaasi mõõt: 370x362 mm</p> <div data-bbox="724 248 983 504" style="text-align: center;">  </div> <div data-bbox="1337 154 1522 327" style="text-align: right;">  <p data-bbox="1366 349 1493 376">440x444 mm</p> </div>				
FS2	<p data-bbox="261 2038 1021 2096">Window handle fittings - Fenstergriff - Poignee de fenetre - Maniglia c/ferramenta - Raamhendel -/grendel -/klink - Aknalink</p>		1		
HS1	<p data-bbox="261 2116 1107 2197">Screw for georgian bars - Schraube für sprossen - Vis pour croisillons - Viti per unire la griglia georgiana della finestra - Schroeven voor raamverdeling - Kruvi akna petfeliistule</p>		4	2.5x20	

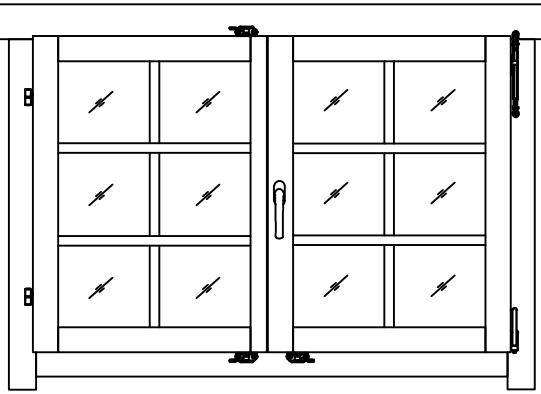
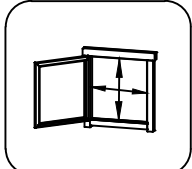
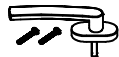
Pos	16.03.2018 Piece list - Stückliste - Liste des pièces - Elementi - Stuklijst - Tükítabel 882x882 AK.1.109.TPSV.b DGP+	1/1	Q	P (mm)	L (mm)
<p data-bbox="261 143 1283 174">Glass size - Glasgröße - Taille de la vitre - Misura del vetro - Glas afmeting - Klaasi mõõt: 712x704 mm</p> <div style="display: flex; justify-content: space-around; align-items: center;">  <div style="text-align: center;">  <p data-bbox="1369 367 1490 394">782x786 mm</p> </div> </div>					
FS2	Window handle fittings - Fenstergriff - Poignee de fenetre - Maniglia c/ferramenta - Raamhendel -/grendel -/klink - Aknalink		1		
HS1	Screw for georgian bars - Schraube für sprossen - Vis pour croisillons - Viti per unire la griglia georgiana della finestra - Schroeven voor raamverdeling - Kruvi akna petfeliistule		8	2.5x20	

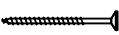
Pos	27.11.2017 Piece list - Stückliste - Liste des pièces - Elementi - Stuklijst - Tükítabel 1290x882 TAK.1.106.TPSP.a DGP+	1/1	Q	P (mm)	L (mm)
	<p data-bbox="263 156 1284 190">Glass size - Glasgröße - Taille de la vitre - Misura del vetro - Glas afmeting - Klaasi mõõt: 515x704 mm</p> <div data-bbox="574 246 1125 638" style="text-align: center;">  </div> <div data-bbox="1332 156 1524 324" style="text-align: right;">  <p data-bbox="1364 347 1492 380">1190x786 mm</p> </div>				
FS2	Window handle fittings - Fenstergriff - Poignée de fenetre - Maniglia c/ferramenta - Raamhendel -/grendel -/klink - Aknalink		1		
HS1	Screw for georgian bars - Schraube für sprossen - Vis pour croisillons - Viti per unire la griglia georgiana della finestra - Schroeven voor raamverdeling - Kruvi akna petteliistule		12	2.5x20	
HS4	Screw for window fillet - Schraube für glasleiste - Vis de filet de fenetre - Vite per assemblaggio finestra - Schroef voor glaslijst - Kruvi akna kokkuvaltšiliistule		3	3x30	

Pos

15.02.2021

Piece list - Stückliste - Liste des pièces - Elementi - Stuklijst - Tükitalabel
1421x510 2+

1/1







Q

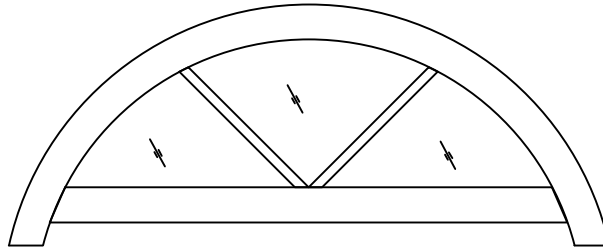

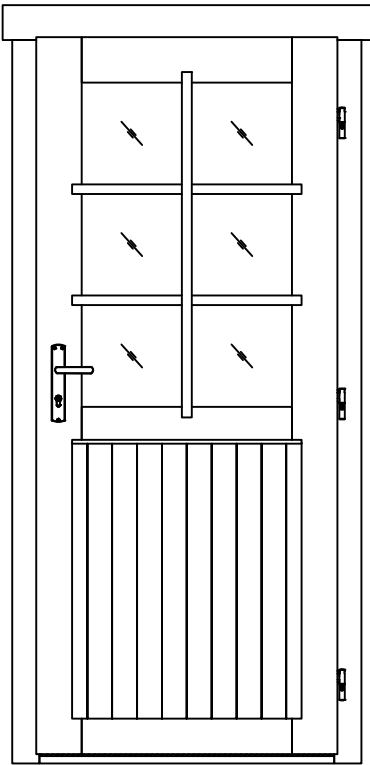
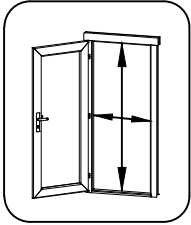
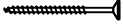
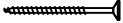

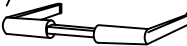

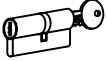



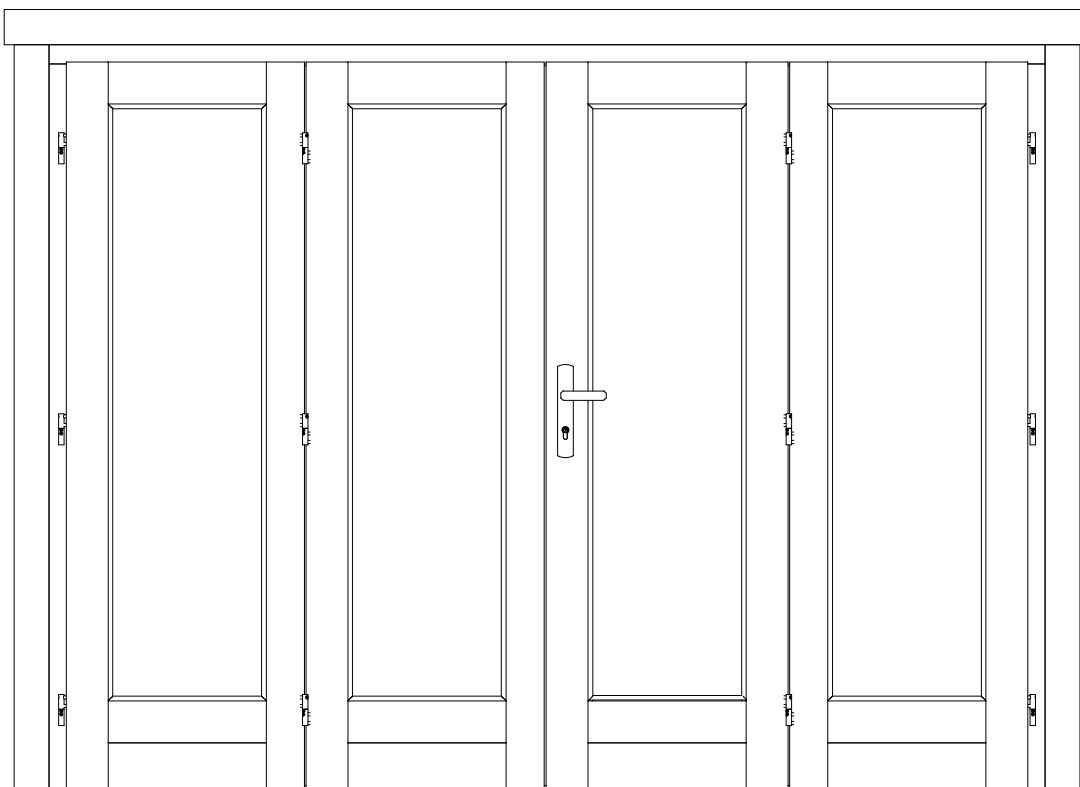
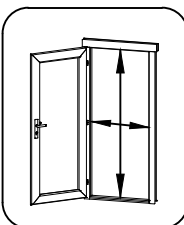
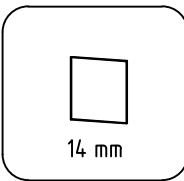

P
(mm)

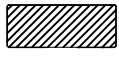
L
(mm)

Glass size - Glasgröße - Taille de la vitre - Misura del vetro - Glas afmeting - Klaasi mõõt: 1290x420 mm

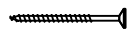
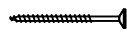

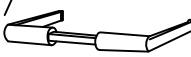
Pos	26.03.2018 Piece list - Stückliste - Liste des pièces - Elementi - Stuklijst - Tükítabel 835x1900 UK.2.056.TPVP.MMWd DGP+	1/1	Q	P (mm)	L (mm)
<p>Glass size - Glasgröße - Taille de la vitre - Misura del vetro - Glas afmeting - Klaasi mõõt: 561x855 mm</p>   <p style="text-align: right;">735x1818 mm</p>					
HS1	Screw for georgian bars - Schraube für sprossen - Vis pour croisillons - Viti per unire la griglia georgiana della finestra - Schroeven voor raamverdeling - Kruvi ukse petteliistule		6	2.5x20	
HS16	Screw for door jamb - Schraube für Türrahmen - Vis de fixation partie haute avec montants du cadre de porte - Viti x fissaggio montanti porte - Schroef voor deurkozijn - Kruvi ukse lengile		4	5x90	
HS25	Screw for doorstep - Schrauben für swelle - Vis pour fixation barre de seuil - Vite per soglia della porta - Schroef voor deurdorpel - Kruvi lävepakule		2	4.5x65	
TL4	Door handle fittings - Türgriff - Poignée de porte - Maniglie - Deurhendel / klink - Ukse käepide VU		1		
TL5	Set of door lock covers - Schlossblenden - Set de garnitures de porte - Copertura serrature - Slot sluitplaat set - Ukse lukuplaat		1		
	Cylinder lock - Zylinderschloss - Barillet de porte - Serratura - Cylinder slot - Ukse lukusüdamik		1	30x35	
	Male bolt hinge for door - Türband - Partie male de paumelle de porte - Cerniera anube x porta - Scharnier bout - Ukse polthing isane		3		
HC	Covers for door hinges - Schutzkappe für Türband - Couverture de paumelle de porte - Copertura delle cerniere della porta - Afdek kap voor deurscharnier - Reguleeritava polthinge kate		6		

Pos	22.07.2020	Delförteckning - Liste over deler - Styklister - Osaluettelo Art.Nr. 9903200	1/3	Q	P (mm)	L (mm)
				 <p>2444x1852 mm</p>  <p>14 mm</p> <p>403x1562 mm</p>		
1	Upper door jamb - Türrahmen oben - Cadre de porte supérieur - Telaio superiore della porta - Bovendorpel - Ukse ülemine leng		1	60x70	2564	
2	Left door jamb - Türrahmen links - Cadre de porte gauche - Telaio montante sinistro della porta - Linkerstijl deurframe - Ukse vasak leng		1	60x70	1889	
2	Right door jamb - Türrahmen rechts - Cadre de porte droit - Telaio montante destro della porta - Rechterstijl deurframe - Ukse parem leng		1	60x70	1889	
3	Doorstep - Swelle - Barre de seuil - Soglia della porta - Deurdorpel - Lävepakk		1	28x70	2464	
4	Covering moulding - Deckungsprofil - Profils de finition verticaux a fixer a l'exterieur du cadre de la porte - Cornice di finitura - Afdek profiel - Lengi piirdelaud		4	18x90	1939	
5	Covering moulding - Deckungsprofil - Profils de finition verticaux a fixer a l'exterieur du cadre de la porte - Cornice di finitura - Afdek profiel - Lengi piirdelaud		2	18x90	2784	
6	Covering moulding - Deckungsprofil - Profils de finition verticaux a fixer a l'exterieur du cadre de la porte - Cornice di finitura - Afdek profiel - Lengi piirdelaud		2	18x45	1957	
7	Covering moulding - Deckungsprofil - Profils de finition verticaux a fixer a l'exterieur du cadre de la porte - Cornice di finitura - Afdek profiel - Lengi piirdelaud		1	18x45	2564	
	Screw for covering moulding - Schrauben für deckungsprofil - Vis de fixation profils horizontaux haut inférieur et extérieur d'encadrement de porte - Vite per cornice di copertura - Schroef voor afdekprofiel - Kruvi piirdelauale		72	3.5x40		
	Screw for door jamb - Schraube für türrahmen - Vis de fixation partie haute avec montants du cadre de porte - Viti x fissaggio montanti porte - Schroef voor deurkozijn - Kruvi ukse lengile		8	5x90		
CL	Cylinder lock - Zylinderschloss - Barillet de porte - Serratura - Cylinder slot - Ukse lukusüdamik		1			
TL4	Door handle fittings - Türgriff - Poignée de porte - Maniglie - Deurhendel / klink - Ukse käepide		1			
TL5	Set of door lock covers - Schlossblenden - Set de garnitures de porte - Copertura serrature - Slot sluitplaat set - Ukse lukuplaat		1			

Art. Nr. 9903200

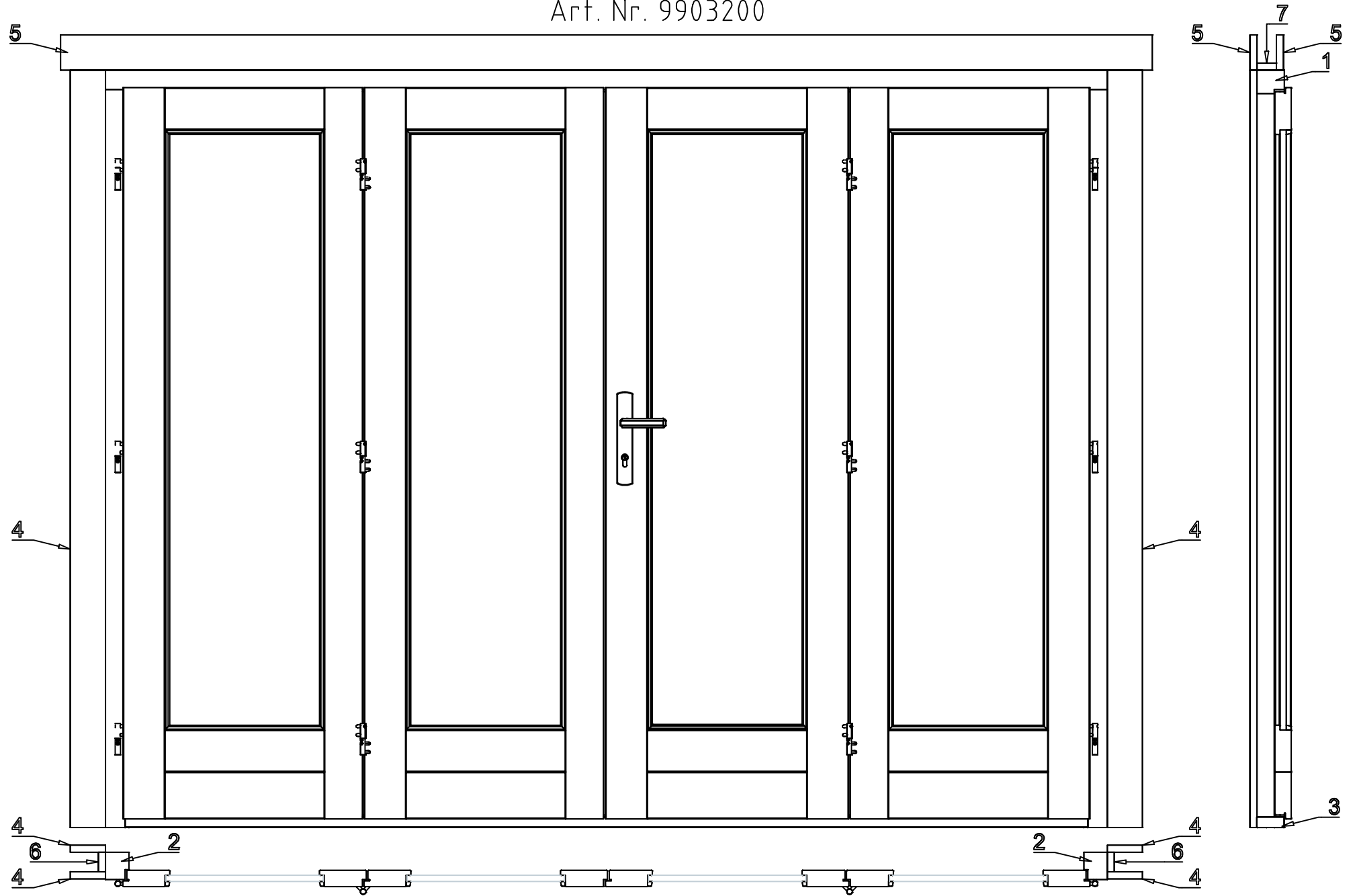

22.07.2020

3/3



