

Staffordshire 2 44, Art.No.4421702  
GROUNDPLAN - GRUNDPLAN - PLAN DE MASSE

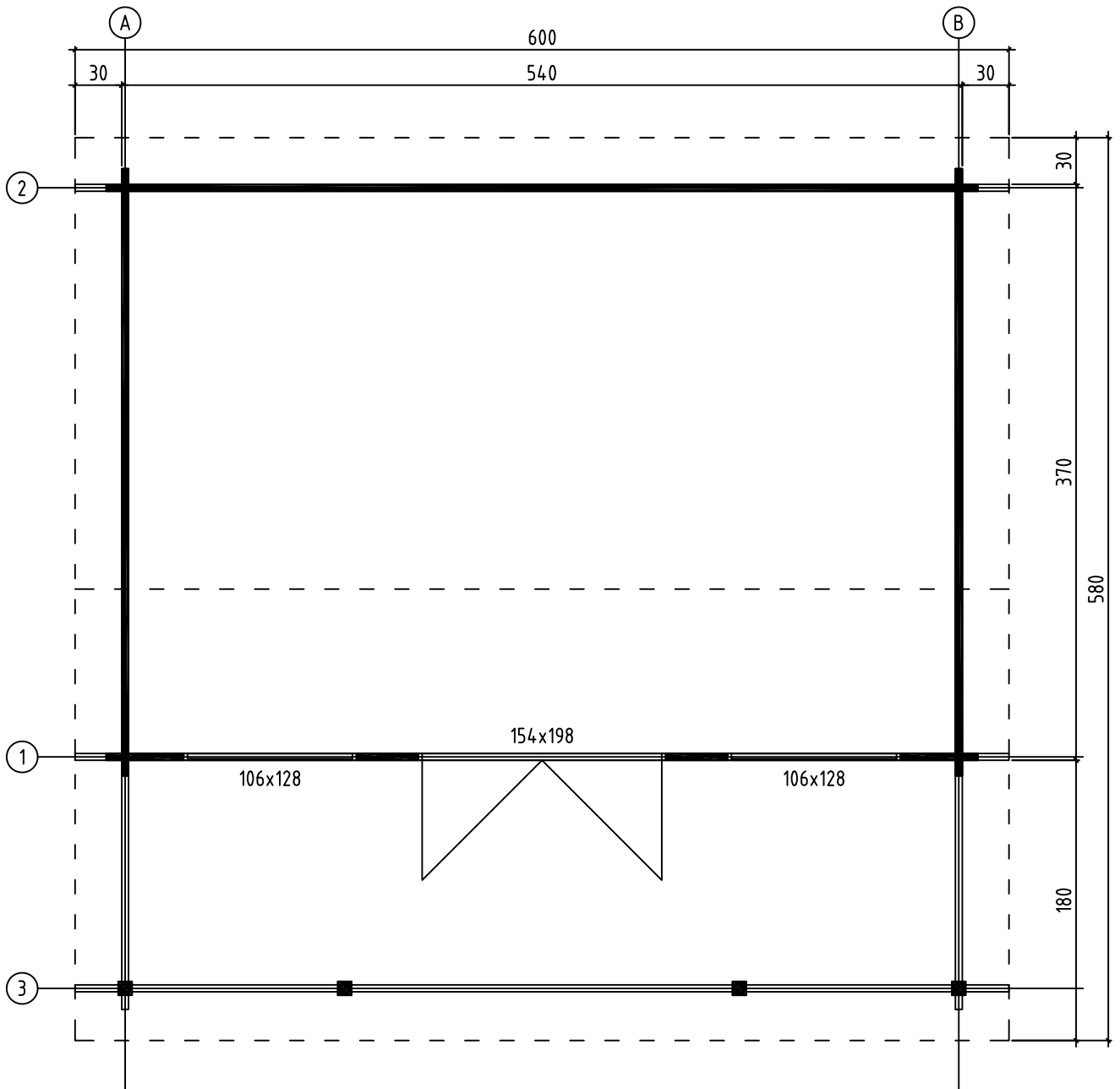

Staffordshire 2 44, Art.No.4421702  
FOUNDATION - FUNDAMENT - FONDATION

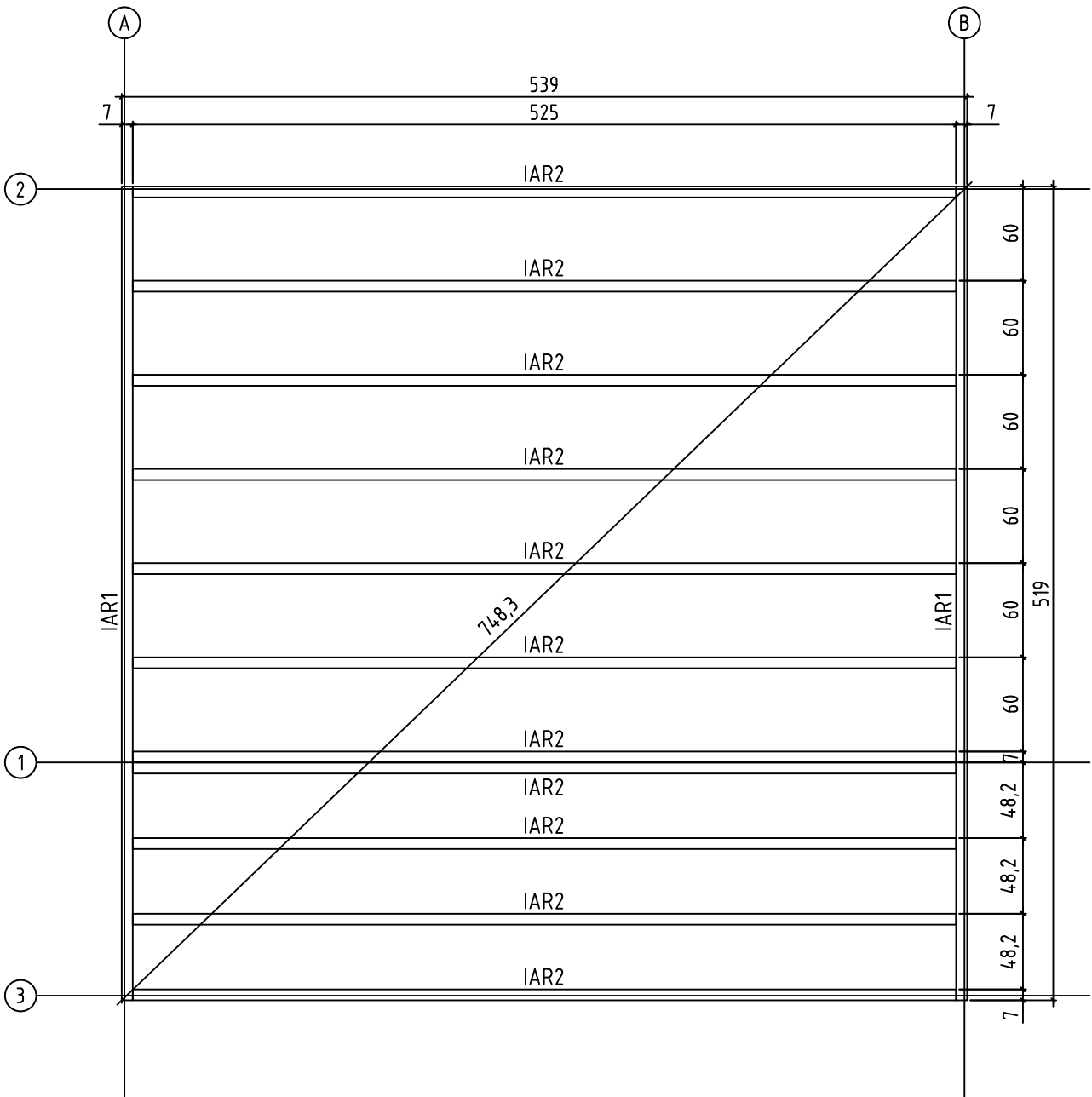

Staffordshire 2 44, Art.No.4421702  
FLOOR BOARDS - FUSSBODENBRETTER - PLAN POSE PLANCHER

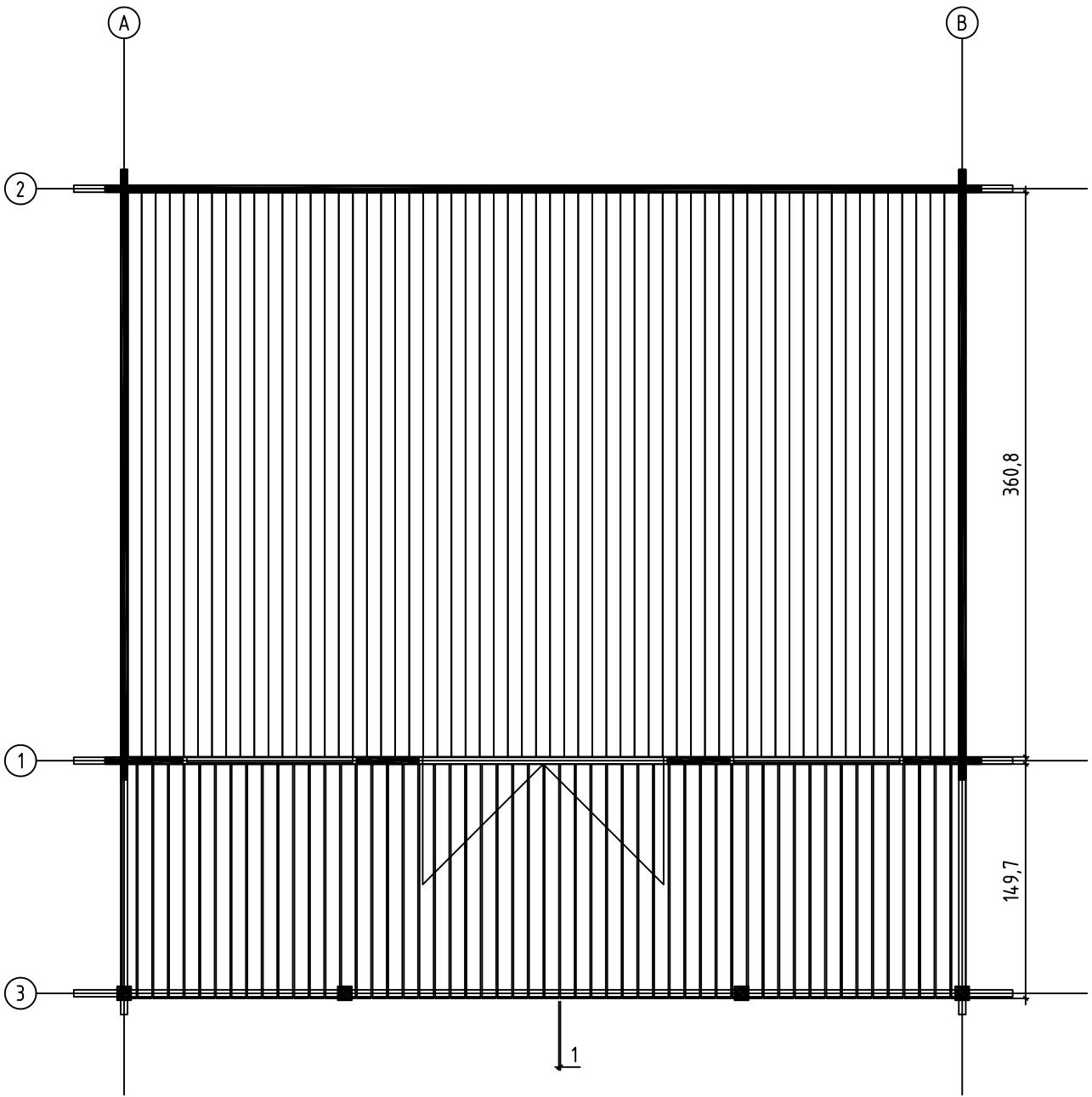



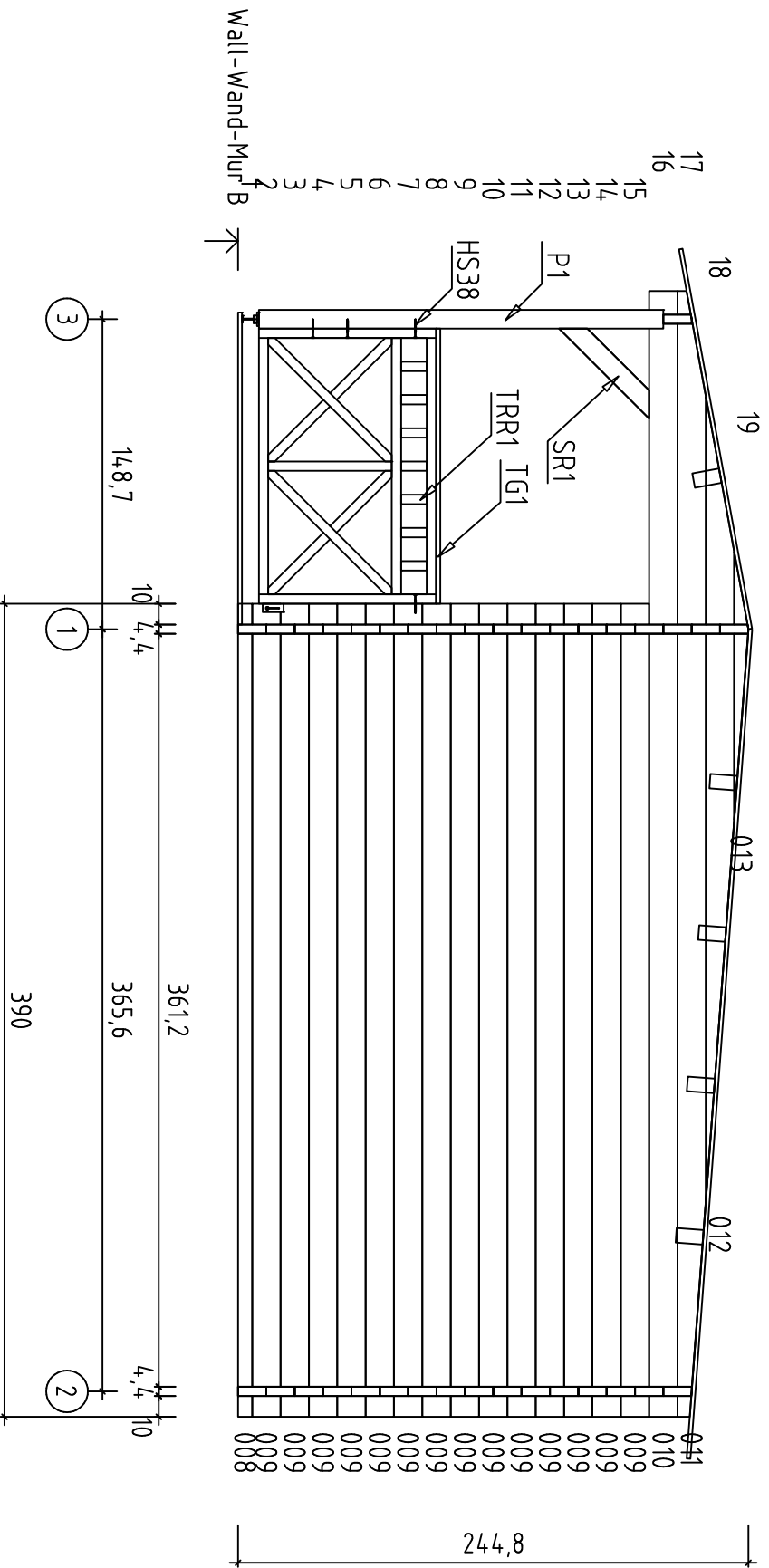

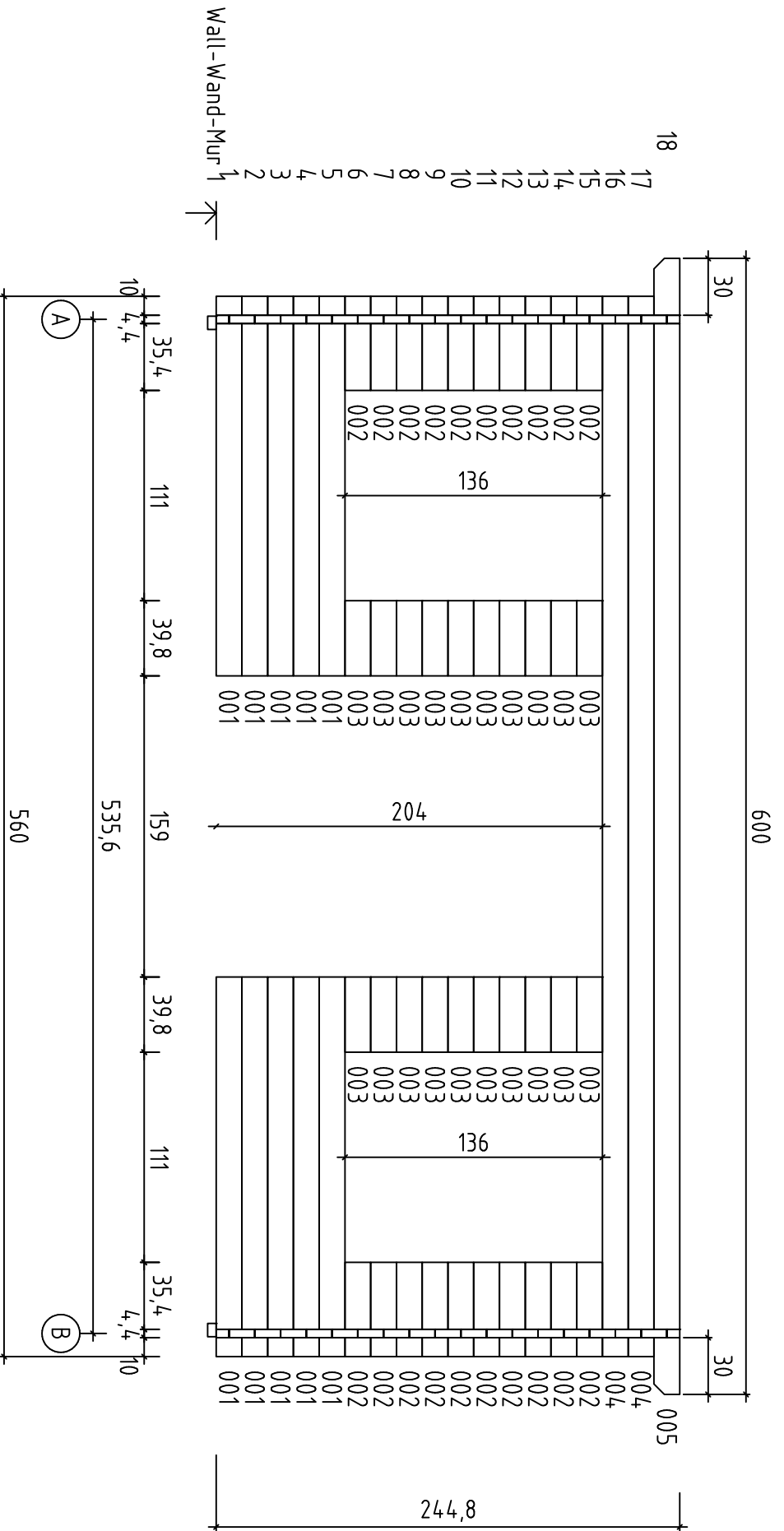

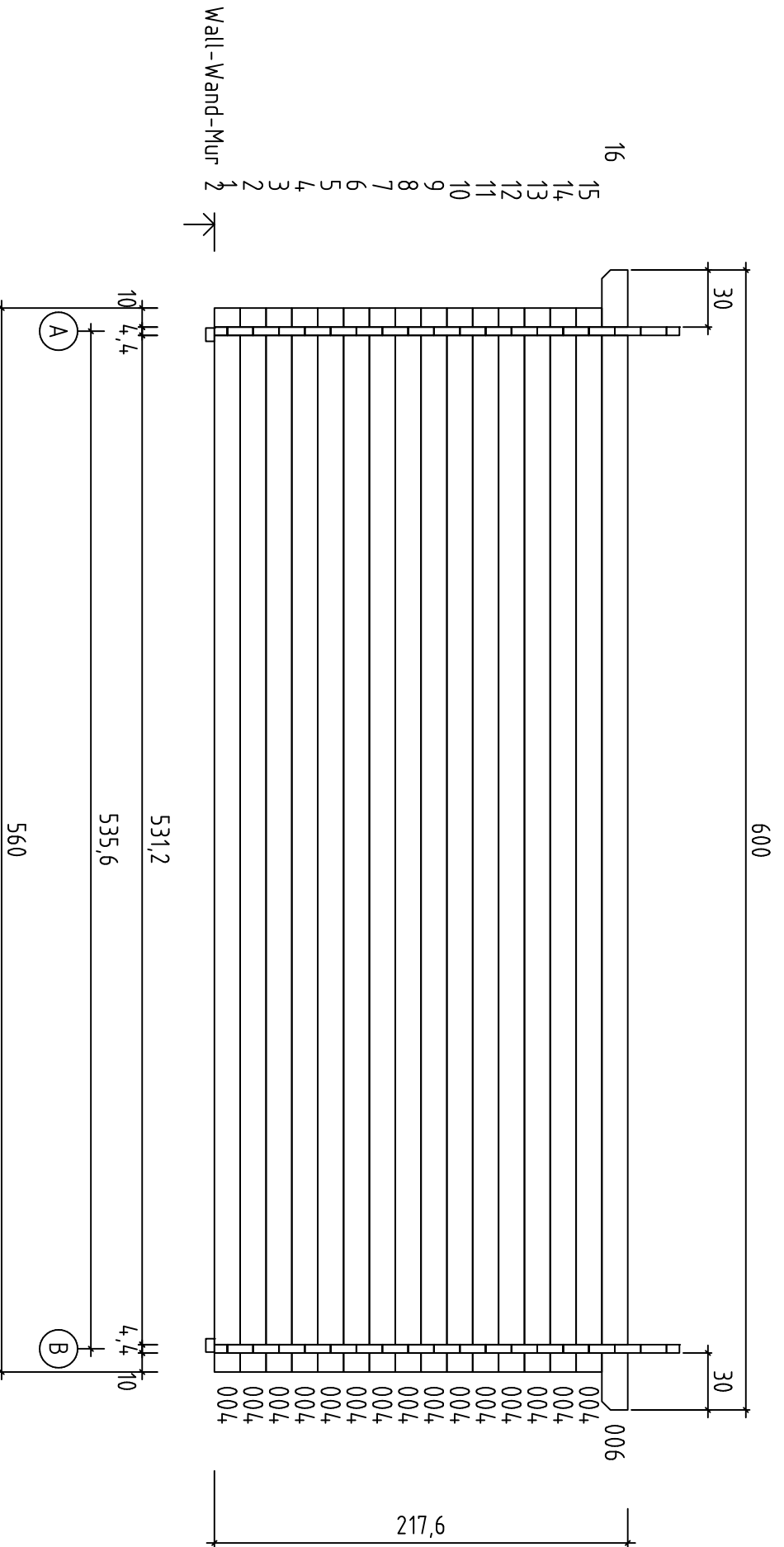

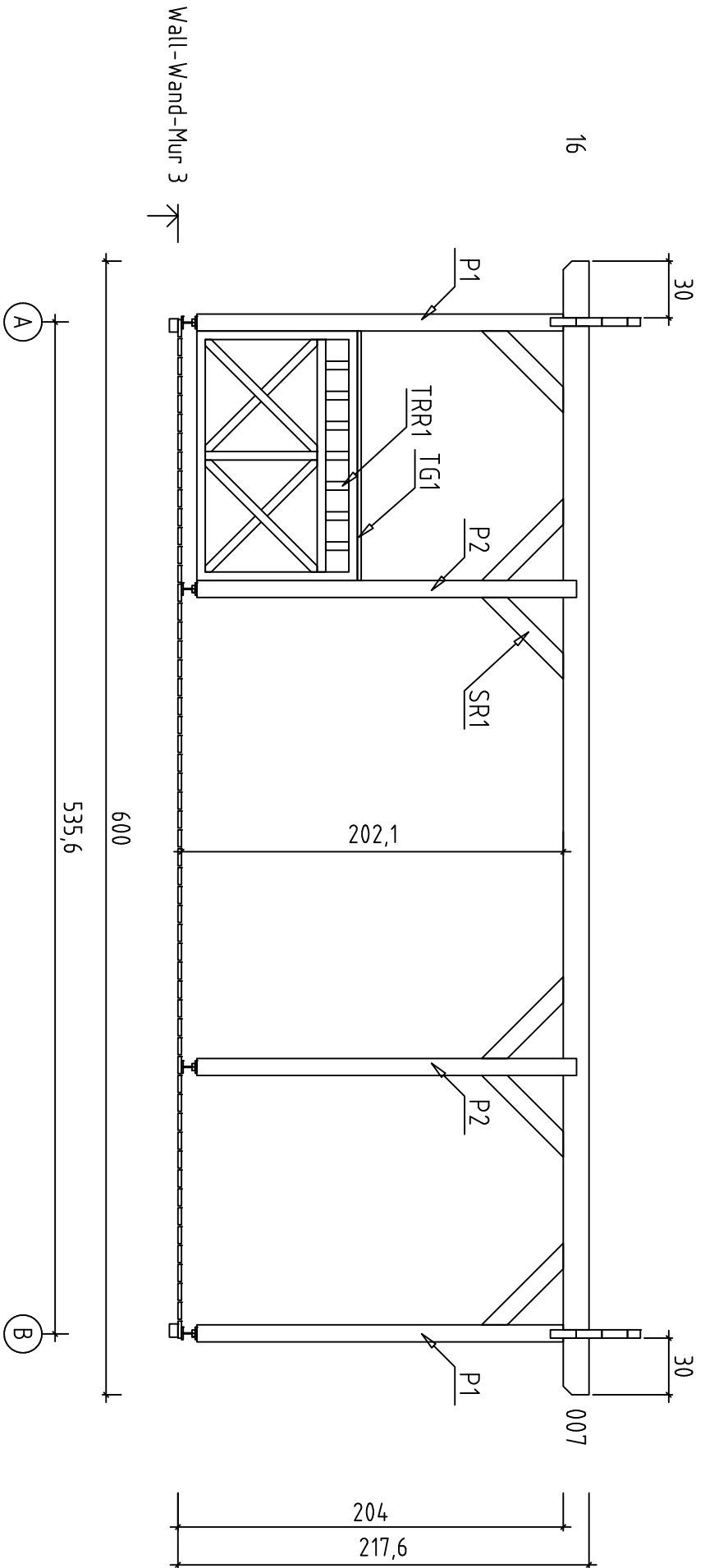



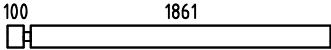

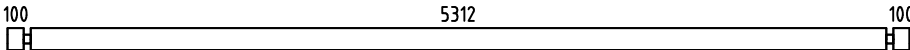
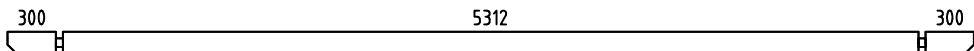
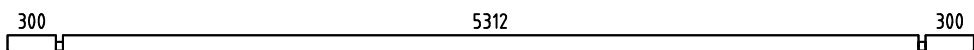
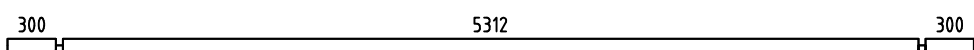
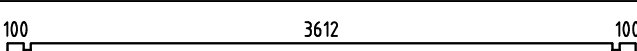
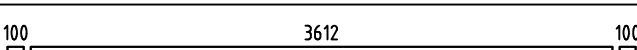
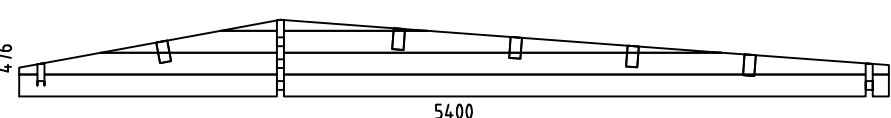
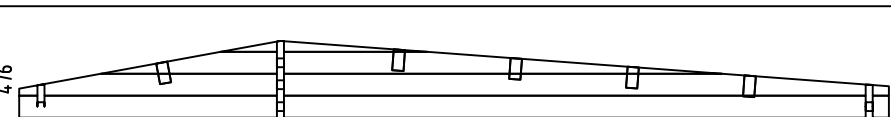
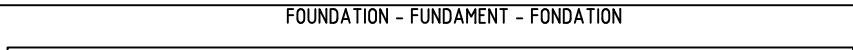
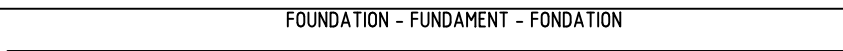
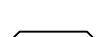

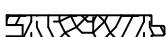
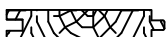



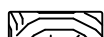
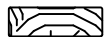





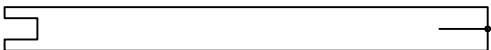

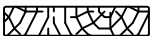

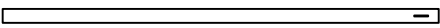
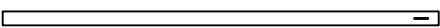
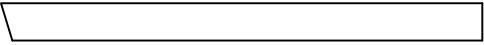
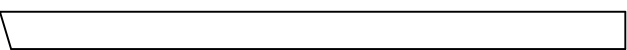

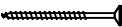
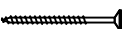

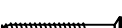



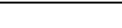
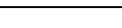
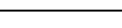
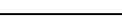

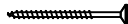
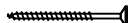







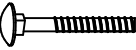

Pos	Staffordshire 2 44, Art.No.4421702 Piece list - Stückliste - Liste des pieces	Q.	P (mm)	L (mm)
001		10	44x136	2005
002		20	44x136	498
003		20	44x136	397
004		17	44x136	5600
005		1	44x136	6000
006		1	44x136	6000
007		1	44x136	6000
008		2	44x68	3900
009		28	44x136	3900
WA-1		1		
WB-1		1		
IAR2	FOUNDATION - FUNDAMENT - FONDATION 	11	70x45	5250
IAR1	FOUNDATION - FUNDAMENT - FONDATION 	2	70x45	5190
SR1	RAFTER - DACHSPARREN - CHEVRON 	8	45x96	611
A-PR1	ROOF BEAM - DACHBALKEN - PANNE DE TOIT 	5	70x140	6000
	FLOOR BOARDS - FUSSBODENBRETTER - LAME DE PLANCHER 	59	90x18	3608
	ROOF BOARDS - DACHBRETTER - VOLIGES 	67	90x18	3989
	ROOF BOARDS - DACHBRETTER - VOLIGES 	67	90x18	1852
SV	TERRACE BOARDS - TERRASSENBRETTER - PLANCHER DE TERRASSE 	54	90x19	1497
	FLOOR FILLET-FUSSBODENLEISTE - CORNIERE DE FINITION DU PLANCHER 		15x40	17.8 m.
DPL	ROOFING FELT FILLET - DACHPAPPENLEISTE - BAGUETTE DE FIXATION DU FEUTRE BITUMEUX 	2	18x58	1902
DPL	ROOFING FELT FILLET - DACHPAPPENLEISTE - BAGUETTE DE FIXATION DU FEUTRE BITUMEUX 	2	18x58	4039
LPL	FIXING FILLET - FIXIRUNGSLEISTE - PROFIL DE FIXATION 	4	20x45	1060

Pos	Staffordshire 2 44, Art.No.4421702 Piece list - Stückliste - Liste des pieces			Q.	P (mm)	L (mm)
LPL	FIXING FILLET - FIXIRUNGSLEISTE - PROFIL DE FIXATION			4	20x45	1320
LPL	FIXING FILLET - FIXIRUNGSLEISTE - PROFIL DE FIXATION			1	20x45	1540
LPL	FIXING FILLET - FIXIRUNGSLEISTE - PROFIL DE FIXATION			2	20x45	2000
P1	POST - PFOSTEN - POTEAU			2	90x90	1930
P2	POST - PFOSTEN - POTEAU			2	90x90	2000
TB	EAVES BOARD - TRAUFBRETT - BANDEAU DE TOIT			2	18x90	6000
DRV	ROOF EDGE REINFORCEMENT - DACHRANDVERSTÄRKUNG - CORNIERE DE RENFORT DE BORD DE TOIT			4	28x34	3000
TG1	GUARD-RAIL FOR TERRACE - TERRASSEN GELÄNDER - MAIN COURANTE DE TERRASSE			4	18x90	1320
KFS	STORM PROTECTION - STURMLEISTE LATTE ANTI-TEMPETE			2	22x45	2070
KFS	STORM PROTECTION - STURMLEISTE LATTE ANTI-TEMPETE			2	22x45	2330
GL	GABLE MOULDING - GIEBELLEISTE - PLANCHE DE RIVE			2	18x120	1902
GL	GABLE MOULDING - GIEBELLEISTE PLANCHE DE RIVE			2	18x120	4039
GS	GABLE SEGMENT-DECKBLATT - LOSANGE DE FINITION			2		
HS12	SCREW FOR GABLE SEGMENT - SCHRAUBEN FÜR DECKBLATT - VIS POUR FIXATION LOSANGE DE FINITION			4	3.5x35	
HS83	SCREW FOR FIXING FILLET - SCHRAUBEN FÜR FIXIRUNGSLEISTE - VIS POUR PROFIL DE FIXATION			51	3.5x50	
HS16	SCREW FOR GABLE MOULDING - SCHRAUBEN FÜR GIEBELLEISTE - VIS DE FIXATION POUR PLANCHE DE RIVE			36	3.5x50	
HS38	SCREW FOR FIXING TERRACE RAILING - SCHRAUBE FÜR TERRASSE VIS DE FIXATION DE GARDE-CORPS DE TERRASSE			20	3.5x50	
NFD	SCREW FOR ROOFING FELT FILLET - SCHRAUBEN FÜR DACHPAPPENLEISTE - VIS POUR BAGUETTE FIXATION FEUTRE BITUMEUX			28	4.5x80	
HS32	SCREW FOR EAVES BOARDS - SCHRAUBEN FÜR TRAUFBRETT - VIS DE FIXATION POUR BANDEAU DE TOIT			26	4x40	
HS26	SCREW FOR ROOF EDGE REINFORCEMENT - SCHRAUBEN FÜR DACHRANDVERSTÄRKUNG - VIS POUR RENFORT DE BORD DE TOIT			26	4x40	
HS45	SCREW FOR SLIDING WALL TIE - SCHRAUBEN FÜR WAND SCHIEBEREGLER SCHIEBEREGLER - VIS POUR FIXATION ÉQUERRE MÉTALLIQUE AU PARAVENT			8	4x40	
HS34	SCREW FOR POST - SCHRAUBEN FÜR PFOSTEN - VIS DE FIXATION DES POTEAUX			8	4x60	
HS30	SCREW FOR TERRACE REAR BOARDS - SCHRAUBEN FÜR TERRASSEN RAND - VIS DE FIXATION POUR MAIN COURANTE DE TERRASSE			16	4x60	
HS40	SCREW FOR 1. WALL BEAM - SCHRAUBE FÜR 1. BOHLENREIHE - VIS DE FIXATION DES FONDATIONS			8	5x120	
HS39	SCREW FOR FUNDAMENT - SCHRAUBEN ZUR BEFESTIGUNG FUNDAMENT - VIS POUR FONDATION			46	5x120	

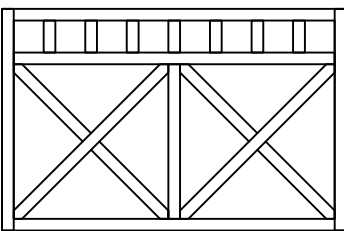
Pos	Staffordshire 2 44, Art.No.4421702 Piece list - Stückliste - Liste des pieces	Q.	P (mm)	L (mm)
HS42	SCREW FOR GABLE - SCHRAUBEN FÜR GIEBEL - VIS POUR FIXATION DES PIGNONS 	12	5x120	
HS43	SCREW FOR ROOF BEAMS - SCHRAUBEN FÜR DACHBALKEN - VIS POUR PANNE DE TOIT 	10	5x120	
HS44	SCREW FOR RAFTER - SCHRAUBEN ZUR BEFESTIGUNG DACHSPARREN - VIS POUR CHEVRON 	16	6x180	
HS49	SCREW FOR POST HEIGHT ADJUSTMENT - SCHRAUBEN FÜR REGULIERUNGSSCHRAUBE FÜR PFOSTEN - VIS DE FIXATION DE SUPPORT RÉGLABLE DE POTEAU 	32	6x50	
MS	SCREW FOR DOORSTEP - SCHRAUBEN FÜR TÜRSCHWELLE - VIS DE FIXATION DU SEUIL DE PORTE 	3	4.5x65	
HS72	SCREW FOR SLIDING WALL TIE - SCHRAUBEN FÜR WAND SCHIEBEREGLER - VIS POUR FIXATION ÉQUERRE MÉTALLIQUE AU PARAVENT 	2	5x60	
SH70	HAMMER BLOCK - SCHLAGHOLZ - CALLE DE FRAPPE 	1		
NF3	ZN NAIL FOR TERRACE - ZN NÄGEL FÜR TERRASSENBRETTTER - POINTE POUR PLANCHER DE TERRASSE 	435	2x50	
NFF	ZN NAIL FOR FLOOR FILLETS - ZN NÄGEL FÜR FUSSBODENLEISTEN - POINTE POUR PANNEAUX DE PLANCHER 	35	1.4x40	
NF2	ZN NAIL FOR ROOF - ZN NÄGEL FÜR DACHBRETTTER - POINTE POUR TOIT 	640	2x50	
NH1	ZN NAIL FOR FLOOR - ZN NÄGEL FÜR FUSSBODENBRETTTER - CLOUS POUR PLANCHER 	430	2x50	
ORZ	MONTAGE SET FOR DOORS AND WINDOWS - MONTAGE-SET FÜR TÜREN UND FENSTER - JEU DE MONTAGE PORTES ET FENETRES	1		
KL5	PLAIN WASHER FOR SLIDING WALL TIE - UNTERLEGSSCHEIBE FÜR WAND SCHIEBEREGLER - RONDELLE POUR SABOT MÉTALLIQUE 	2		
WLGR	SLIDING WALL TIE - SCHIEBEREGLER FÜR WAND - EQUERRE MÉTALLIQUE DE FIXATION DU PARAVENT 	2		
SFS	NUT FOR STORM PROTECTION - SCHRAUBENMUTTER FÜR STURMLEISTE - ÉCROU POUR LAME ANTI-TEMPETE 	8		
BFS	BOLT FOR STORM PROTECTION - BOLZEN FÜR STURMLEISTE - VIS POUR LAME ANTI-TEMPETE 	8		
DFS	WASHER FOR STORM PROTECTION - DICHTSCHEIBE FÜR STURMLEISTE - RONDELLE POUR LAME ANTI-TEMPETE 	8		
RFP	POST HEIGHT ADJUSTMENT - REGULIERUNGSSCHRAUBE FÜR PFOSTEN - SUPPORT RÉGLABLE DE POTEAU 	4		
TRR1	TERRACE RAILING - TERRASSE - GARDE-CORPS DE TERRASSE 	4	850	1320

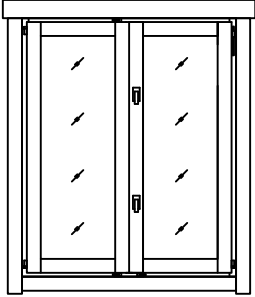
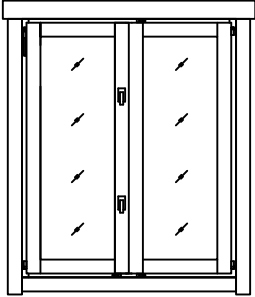
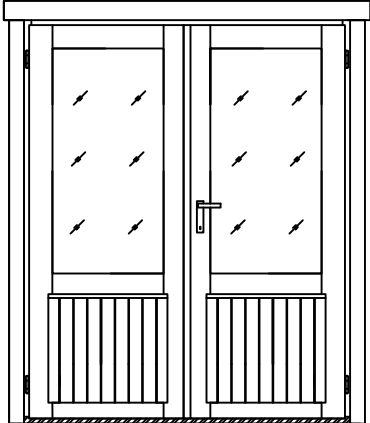
Pos	Staffordshire 2 44, Art.No.4421702 Piece list - Stückliste - Liste des pieces	Q.	P (mm)	L (mm)
2+ TA .0P.d	WINDOW-FENSTER-FENETRE 1200x1320  	1		
2+ TA .0V.d	WINDOW-FENSTER-FENETRE 1200x1320  	1		
2+ TU .20P.b	DOOR-TÜR-PORTE 1580x2000  	1		

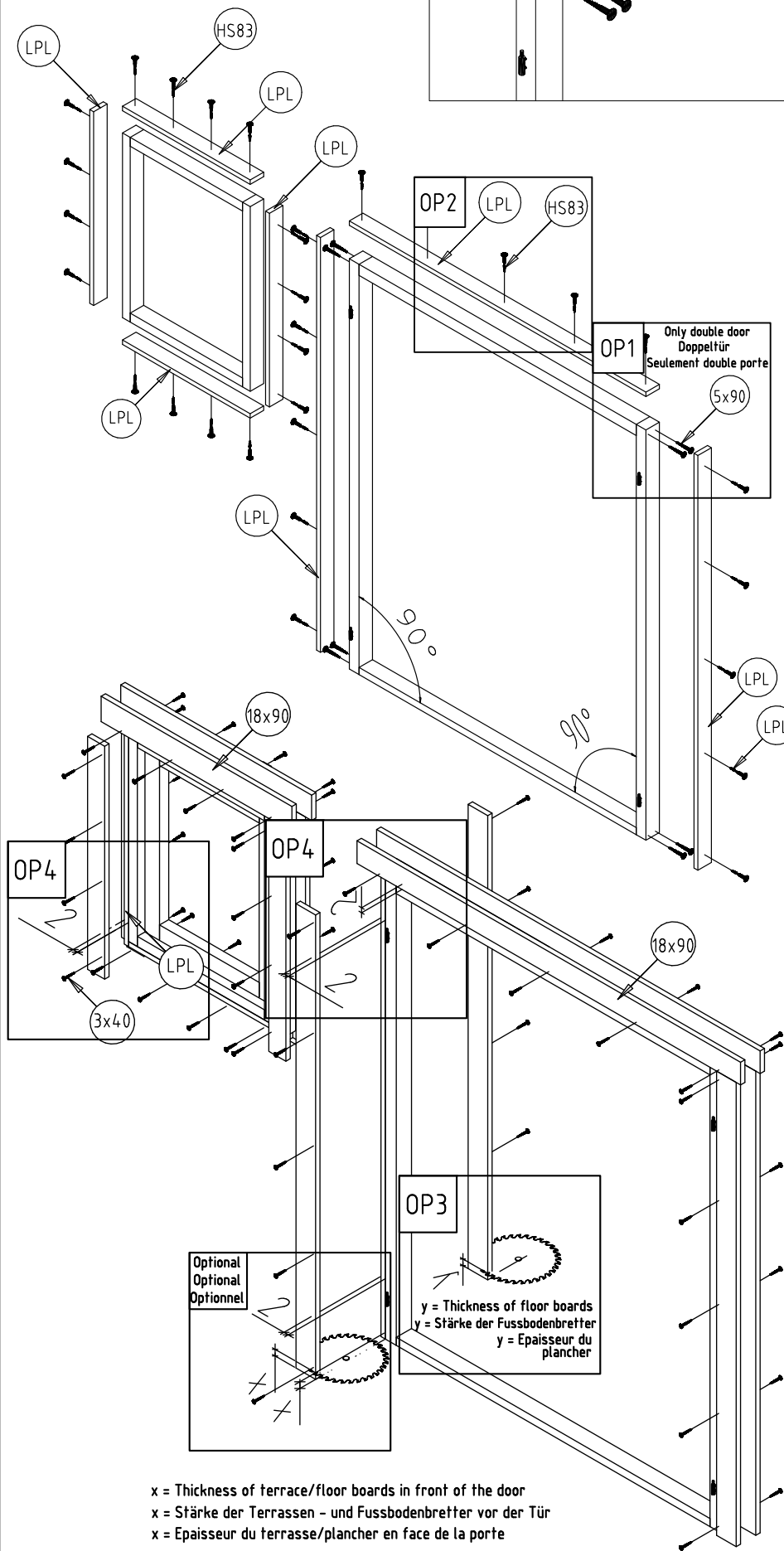
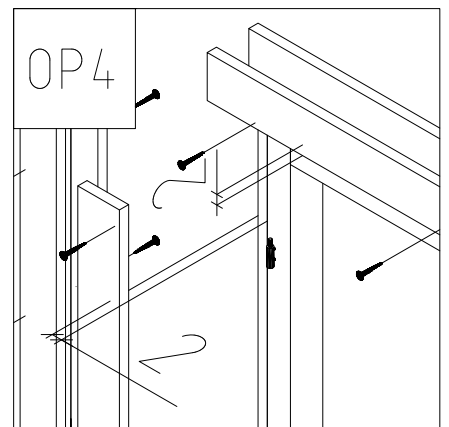
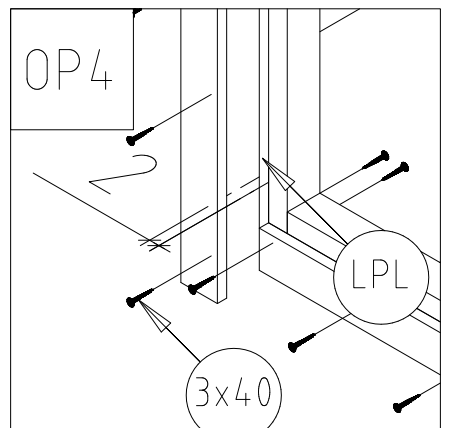
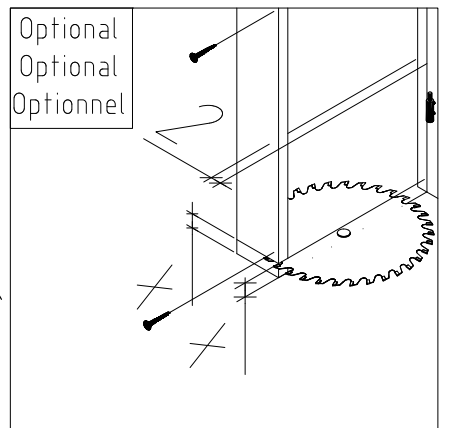
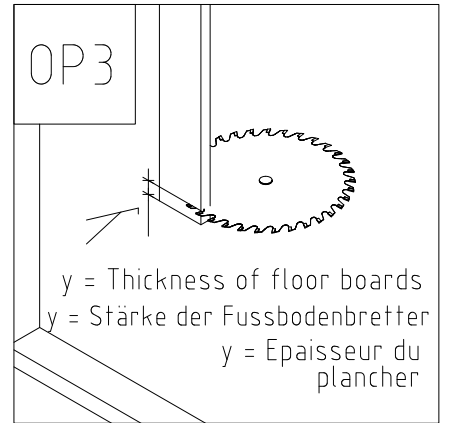
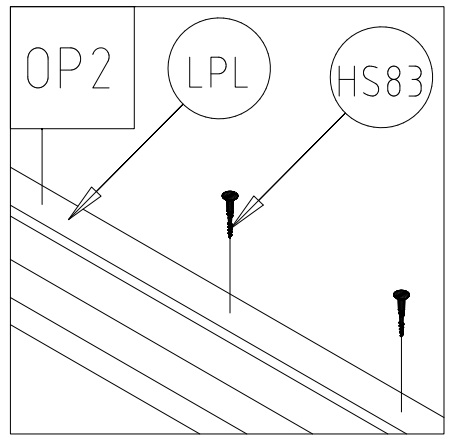
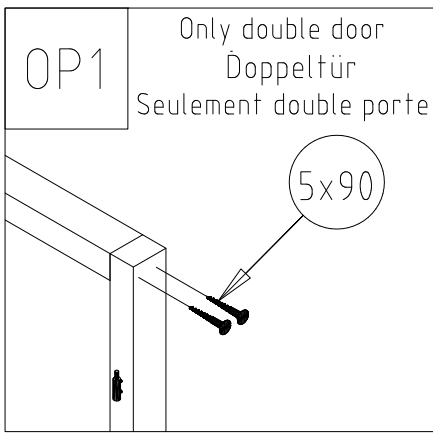

x = Thickness of terrace/floor boards in front of the door  
x = Stärke der Terrassen - und Fussbodenbretter vor der Tür  
x = Epaisseur du terrasse/plancher en face de la porte

