

Staffordshire 2 70, Art.No.7012502  
GROUNDPLAN - GRUNDPLAN - PLAN DE MASSE

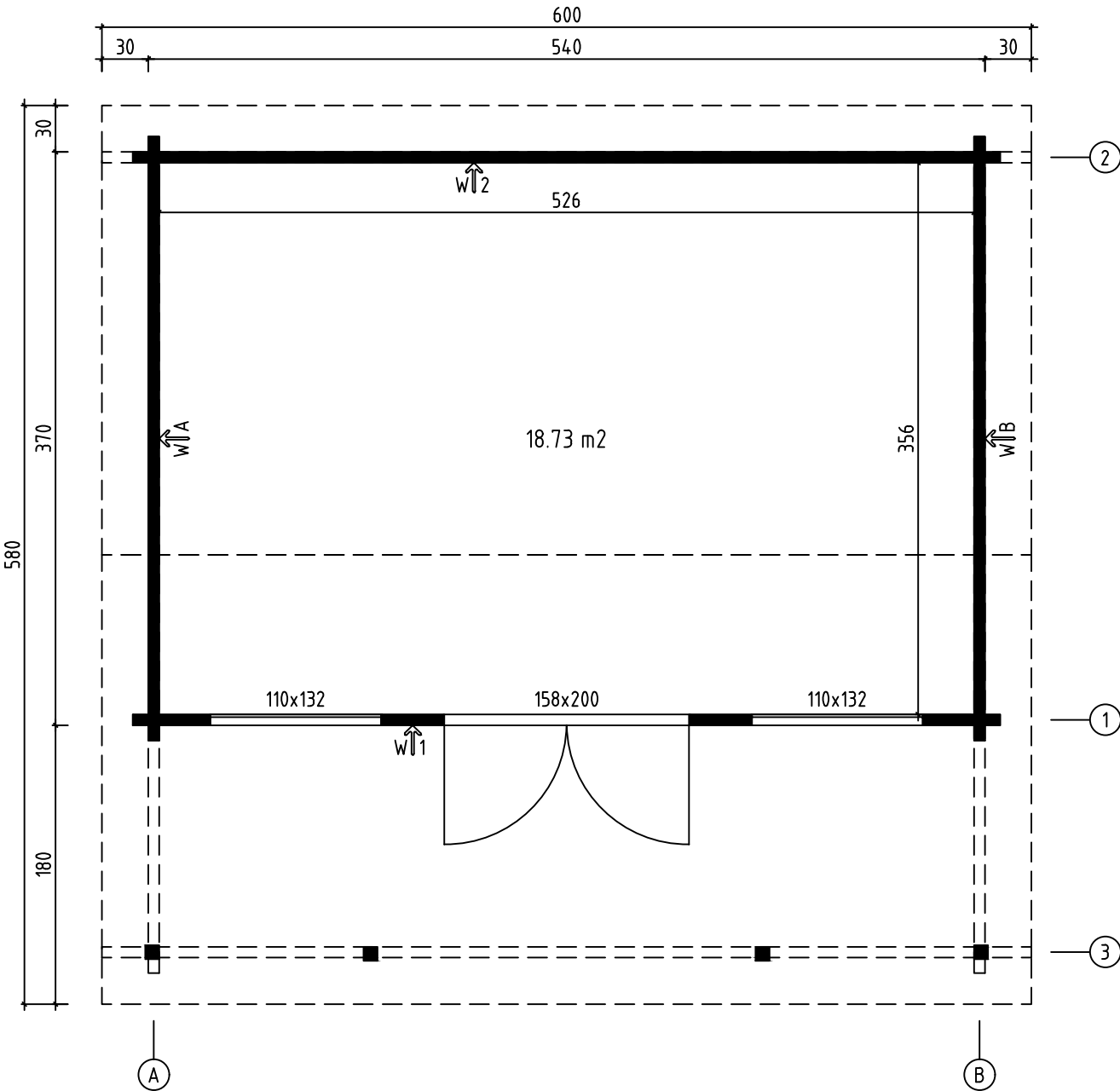

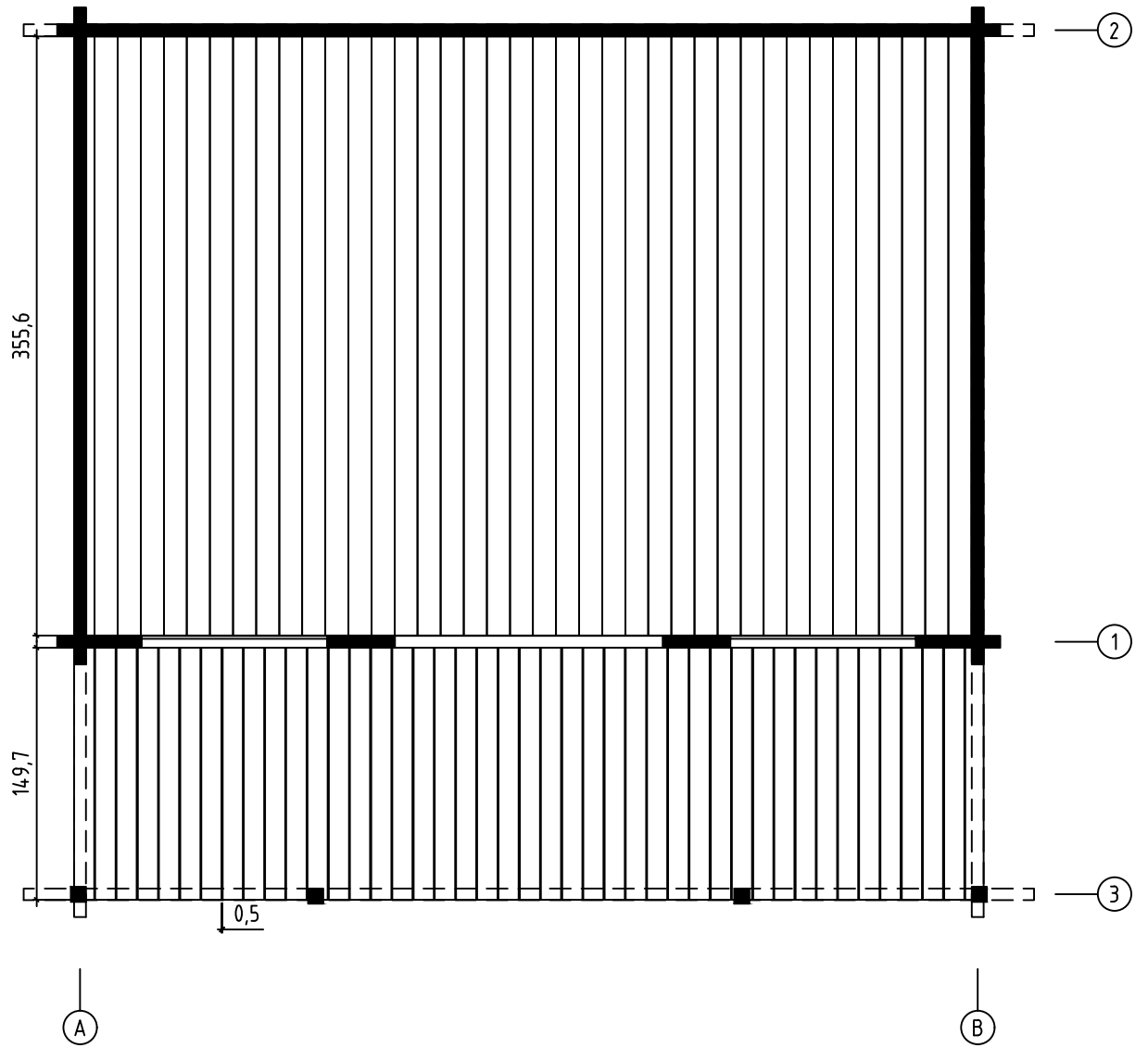

Staffordshire 2 70, Art.No.7012502  
FLOOR BOARDS - FUSSBODENBRETTER - PLAN POSE PLANCHER  
TERRACE BOARDS - TERRASSENBRETTER - PLANCHER DE TERRASSE



Staffordshire 2 70, Art.No.7012502

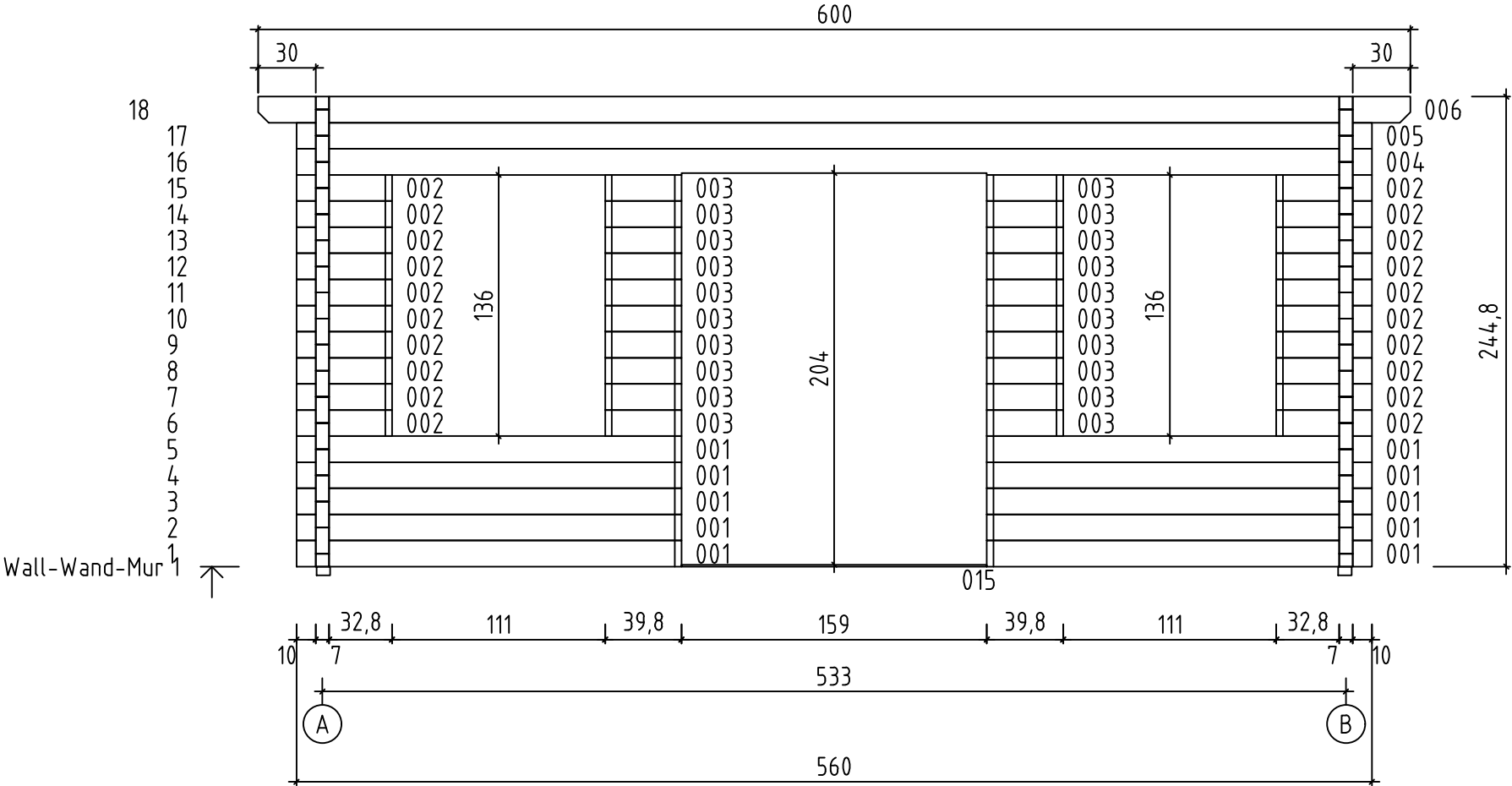

Staffordshire 2 70, Art.No.7012502

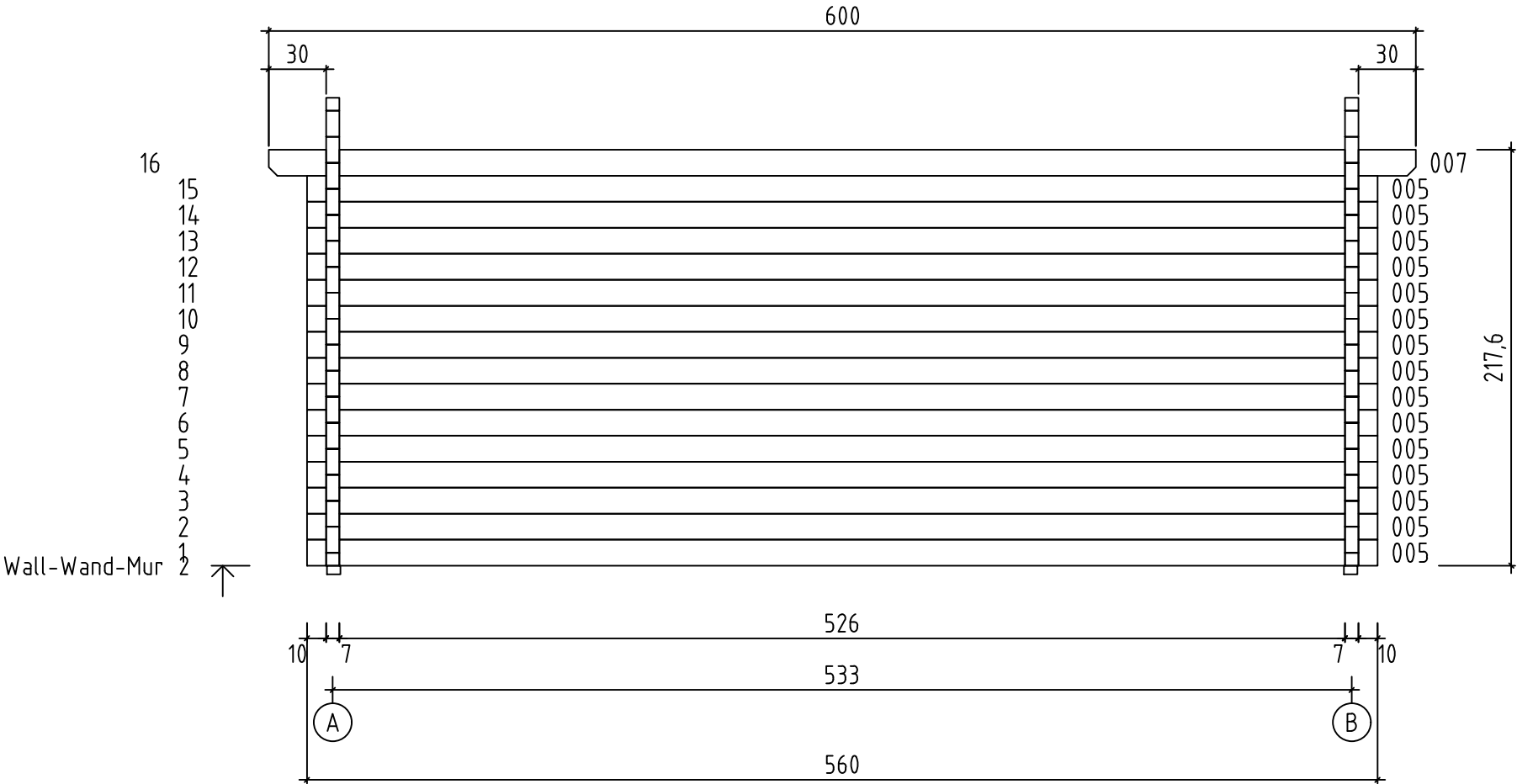



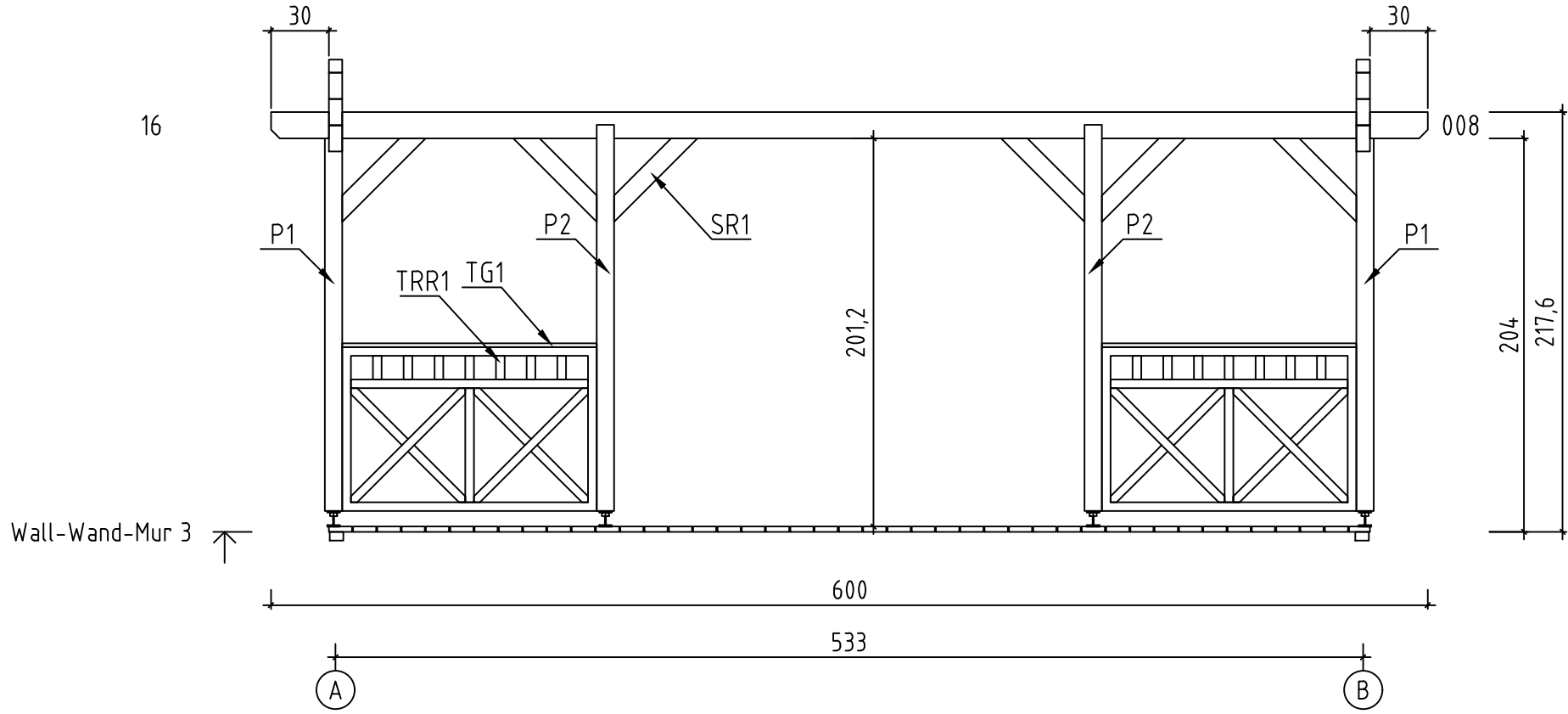







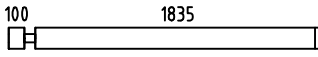

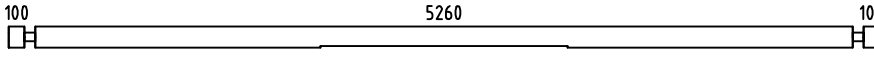
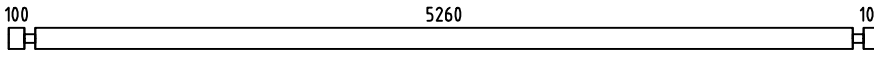
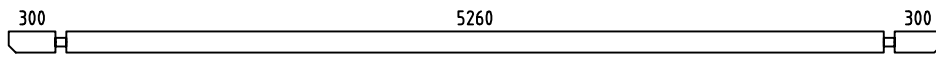
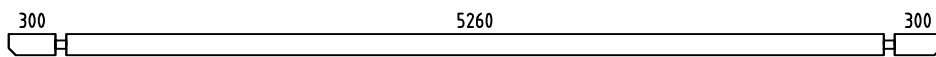
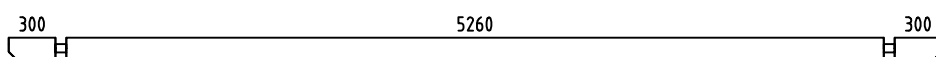
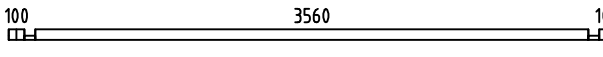
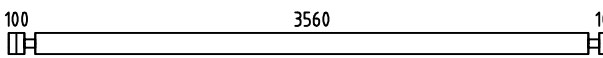
Staffordshire 2 70, Art.No.7012502

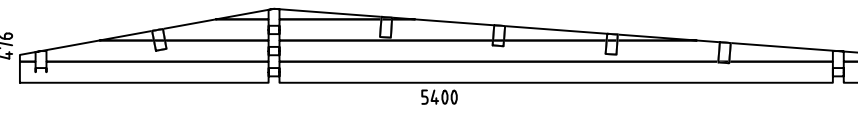
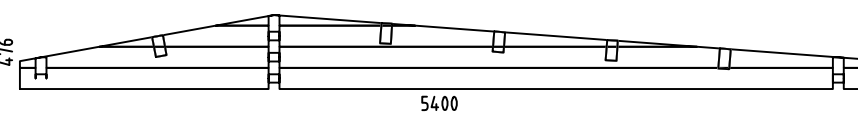

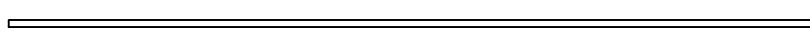
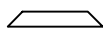
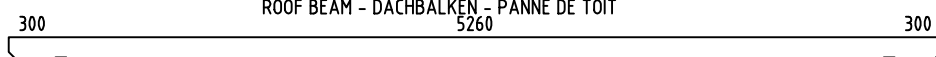
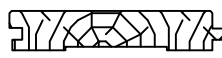

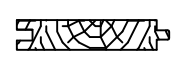





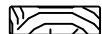







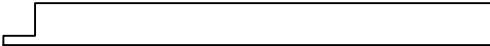
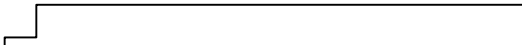



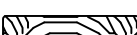
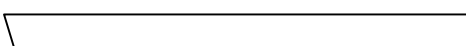
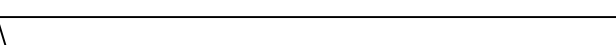





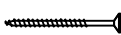



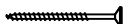









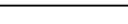
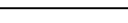
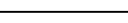

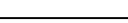



Pos	Staffordshire 2 70, Art.No.7012502 Piece list - Stückliste - Liste des pieces	Q.	P (mm)	L (mm)
001		10	70x136	2005
002		20	70x136	497
003		20	70x136	397
004		1	70x136	5600
005		16	70x136	5600
006		1	70x136	6000
007		1	70x136	6000
008		1	70x136	6000
009		2	70x68	3900
010		28	70x136	3900
015		1	70x10	1590
WA-1		1		
WB-1		1		
IAR2	FOUNDATION - FUNDAMENT - FONDATION 	12	70x45	5250
IAR1	FOUNDATION - FUNDAMENT - FONDATION 	2	70x45	5190
SR1	RAFTER - DACHSPARREN - CHEVRON 	8	45x96	611
A-PR1	ROOF BEAM - DACHBALKEN - PANNE DE TOIT 	5	70x140	6000
PTL	FLOOR BOARDS - FUSSBODENBRETTER - LAME DE PLANCHER 	47	112x28	3556
	ROOF BOARDS - DACHBRETTER - VOLIGES 	67	90x18	3976
	ROOF BOARDS - DACHBRETTER - VOLIGES 	67	90x18	1865
SV2	TERRACE BOARDS - TERRASSENBRETTER - PLANCHER DE TERRASSE 	43	120x28	1497
	FLOOR FILLET-FUSSBODENLEISTE - CORNIERE DE FINITION DU PLANCHER 		15x40	17.6 m.
DPL	ROOFING FELT FILLET - DACHPAPPENLEISTE - BAGUETTE DE FIXATION DU FEUTRE BITUMEUX 	2	18x58	1915
Nimi	Art.nr.	Kuupäev	Leht 1/4	

Pos	Staffordshire 2 70, Art.No.7012502 Piece list - Stückliste - Liste des pieces	Q.	P (mm)	L (mm)
DPL	ROOFING FELT FILLET - DACHPAPPENLEISTE - BAGUETTE DE FIXATION DU FEUTRE BITUMEUX 	2	18x58	4026
M12	TREADED ROD M12 - GEWINDESTANGE M12 - TIGE FILETÉE M12 	2		200
M12	TREADED ROD M12 - GEWINDESTANGE M12 - TIGE FILETÉE M12 	2		420
M12	TREADED ROD M12 - GEWINDESTANGE 12 - TIGE FILETÉE M12 	4		2000
LPL	FIXING FILLET - FIXIRUNGSLEISTE - PROFIL DE FIXATION 	4	20x70	1060
LPL	FIXING FILLET - FIXIRUNGSLEISTE - PROFIL DE FIXATION 	4	20x70	1320
LPL	FIXING FILLET - FIXIRUNGSLEISTE - PROFIL DE FIXATION 	1	20x70	1540
LPL	FIXING FILLET - FIXIRUNGSLEISTE - PROFIL DE FIXATION 	2	20x70	2000
P1	POST - PFOSTEN - POTEAU 	2	90x90	1930
P2	POST - PFOSTEN - POTEAU 	2	90x90	2000
TB	EAVES BOARD - TRAUFBRETT - BANDEAU DE TOIT 	2	18x90	6000
DRV	ROOF EDGE REINFORCEMENT - DACHRANDVERSTÄRKUNG - CORNIERE DE RENFORT DE BORD DE TOIT 	4	28x34	3000
TBE6	FIXING FILLET FOR WINDOW - FIXIRUNGSLEISTE FÜR FENSTER - PROFIL DE FIXATION DES FENETRES 	4	28x34	1320
TBE6	FIXING FILLET FOR DOOR - FIXIRUNGSLEISTE FÜR TÜR - PROFIL DE FIXATION DES PORTES 	2	28x34	2000
TG1	GUARD-RAIL FOR TERRACE - TERRASSEN GELÄNDER - MAIN COURANTE DE TERRASSE 	4	18x90	1320
GL	GABLE MOULDING - GIEBELLEIST PLANCHE DE RIVE 	2	18x120	1915
GL	GABLE MOULDING - GIEBELLEIST PLANCHE DE RIVE 	2	18x120	4026
SH70	HAMMER BLOCK - SCHLAGHOLZ - CALLE DE FRAPPE 	1		
KL4	LENGTHENING BOLT FOR TREADED ROD - VERLÄNGERUNGSMUTTER FÜR GEWINDESTANGE - MANCHON DE RACCORDEMENT DE TIGE FILETÉE 	4		
KL1	DRIVE NUT TREADED ROD - EINSHLAGMUTTER FÜR GEWINDESTANGE - ÉCROU A FRAPPER POUR TIGE FILETÉE 	4		
KL2	NUT FOR TREADED ROD - MUTTER FÜR GEWINDESTANGE - ÉCROU POUR TIGE FILETÉE 	4		
KL3	PLAIN WASHER TREADED ROD - UNTERLEGSCHLEIBE FÜR GEWINDESTANGE - RONDELLE PLATE POUR TIGE FILETÉE 	4		
HS12	SCREW FOR GABLE SEGMENT - SCHRAUBEN FÜR DECKBLATT - VIS POUR FIXATION LOSANGE DE FINITION 	4	3.5x35	
HS83	SCREW FOR FIXING FILLET - SCHRAUBEN FÜR FIXIRUNGSLEISTE - VIS POUR PROFIL DE FIXATION 	51	3.5x50	
HS84	SCREW FOR FIXING FILLET - SCHRAUBEN FÜR FIXIRUNGSLEISTE - VIS POUR PROFIL DE FIXATION 	36	3.5x50	
Nimi	Art.nr.	Kuupäev	Leht 2/4	

Pos	Staffordshire 2 70, Art.No.7012502 Piece list - Stückliste - Liste des pieces	Q.	P (mm)	L (mm)
HS16	SCREW FOR GABLE MOULDING - SCHRAUBEN FÜR GIEBELLEISTE - VIS DE FIXATION POUR PLANCHE DE RIVE 	36	3.5x50	
HS38	SCREW FOR FIXING TERRACE RAILING - SCHRAUBE FÜR TERRASSE VIS DE FIXATION DE GARDE-CORPS DE TERRASSE 	20	4.5x80	
NFD	SCREW FOR ROOFING FELT FILLET - SCHRAUBEN FÜR DACHPAPPENLEISTE - VIS POUR BAGUETTE FIXATION FEUTRE BITUMEUX 	28	4x40	
HS32	SCREW FOR EAVES BOARDS - SCHRAUBEN FÜR TRAUFBRETTER - VIS DE FIXATION POUR BANDEAU DE TOIT 	26	4x40	
HS26	SCREW FOR ROOF EDGE REINFORCEMENT - SCHRAUBEN FÜR DACHRANDVERSTÄRKUNG - VIS POUR RENFORT DE BORD DE TOIT 	26	4x40	
HS45	SCREW FOR SLIDING WALL TIE - SCHRAUBEN FÜR WAND SCHIEBEREGLER SCHIEBEREGLER - VIS POUR FIXATION ÉQUERRE MÉTALLIQUE AU PARAVENT 	8	4x40	
HS30	SCREW FOR TERRACE REAR BOARDS - SCHRAUBEN FÜR TERRASSENRAND - VIS DE FIXATION POUR MAIN COURANTE DE TERRASSE 	16	4x60	
HS34	SCREW FOR POST - SCHRAUBEN FÜR PFOSTEN - VIS DE FIXATION DES POTEAUX 	8	4x60	
HS40	SCREW FOR 1. WALL BEAM - SCHRAUBE FÜR 1. BOHLENREIHE - VIS DE FIXATION DES FONDATIONS 	8	5x120	
HS39	SCREW FOR FUNDAMENT - SCHRAUBEN ZUR BEFESTIGUNG FUNDAMENT - VIS POUR FONDATION 	52	5x120	
HS42	SCREW FOR GABLE - SCHRAUBEN FÜR GIEBEL - VIS POUR FIXATION DES PIGNONS 	12	5x120	
HS43	SCREW FOR ROOF BEAMS - SCHRAUBEN FÜR DACHBALKEN - VIS POUR PANNE DE TOIT 	10	5x120	
HS44	SCREW FOR RAFTER - SCHRAUBEN ZUR BEFESTIGUNG DACHSPARREN - VIS POUR CHEVRON 	16	6x180	
HS49	SCREW FOR POST HEIGHT ADJUSTMENT - SCHRAUBEN FÜR REGULIERUNGSSCHRAUBE FÜR PFOSTEN - VIS DE FIXATION DE SUPPORT RÉGLABLE DE POTEAU 	32	6x50	
MS	SCREW FOR DOORSTEP - SCHRAUBEN FÜR TÜRSCHWELLE - VIS DE FIXATION DU SEUIL DE PORTE 	3	4.5x65	
HS72	SCREW FOR SLIDING WALL TIE - SCHRAUBEN FÜR WAND SCHIEBEREGLER - VIS POUR FIXATION ÉQUERRE MÉTALLIQUE AU PARAVENT 	2	5x60	
NF3	ZN NAIL FOR TERRACE - ZN NÄGEL FÜR TERRASSENBRETTER - POINTE POUR PLANCHER DE TERRASSE 	350	2x50	
NFF	ZN NAIL FOR FLOOR FILLETS - ZN NÄGEL FÜR FUSSBODENLEISTEN - POINTE POUR PANNEAUX DE PLANCHER 	35	1.4x40	
NF2	ZN NAIL FOR ROOF - ZN NÄGEL FÜR DACHBRETTER - POINTE POUR TOIT 	640	2x50	
NH1	ZN NAIL FOR FLOOR - ZN NÄGEL FÜR FUSSBODENBRETTER - CLOUS POUR PLANCHER 	350	2x50	
ORZ	MONTAGE SET FOR DOORS AND WINDOWS - MONTAGE-SET FÜR TÜREN UND FENSTER - JEU DE MONTAGE PORTES ET FENETRES	1		
GS	GABLE SEGMENT-DECKBLATT - LOSANGE DE FINITION 	2		
KL5	PLAIN WASHER FOR SLIDING WALL TIE - UNTERLEGSCHIEBE FÜR WAND SCHIEBEREGLER - RONDELLE POUR SABOT MÉTALLIQUE 	2		
WLGR	SLIDING WALL TIE - SCHIEBEREGLER FÜR WAND - EQUERRE MÉTALLIQUE DE FIXATION DU PARAVENT 	2		
RFP	POST HEIGHT ADJUSTMENT - REGULIERUNGSSCHRAUBE FÜR PFOSTEN - SUPPORT RÉGLABLE DE POTEAU	4		
Nimi	Art.nr.	Kuupäev	Leht 3/4	

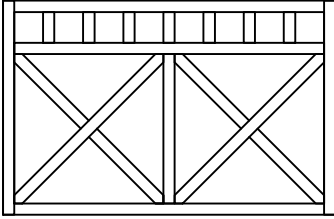
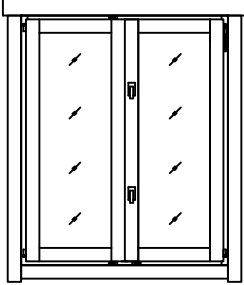
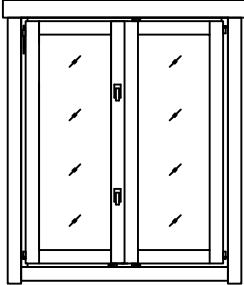
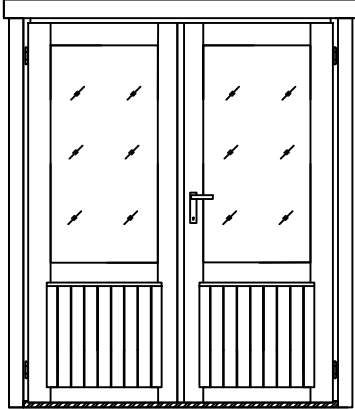
Pos	Staffordshire 2 70, Art.No.7012502 Piece list - Stückliste - Liste des pieces	Q.	P (mm)	L (mm)
TRR1	TERRACE RAILING - TERRASSE - GARDE-CORPS DE TERRASSE 	4	850	1320
2+ TA .0P.d	WINDOW-FENSTER-FENETRE 1200x1320 	1		
2+ TA .0V.d	WINDOW-FENSTER-FENETRE 1200x1320 	1		
2+ TU .20P.b	DOOR-TÜR-PORTE 1580x2000 	1		
Nimi	Art.nr.	Kuupäev	Leht 4/4	

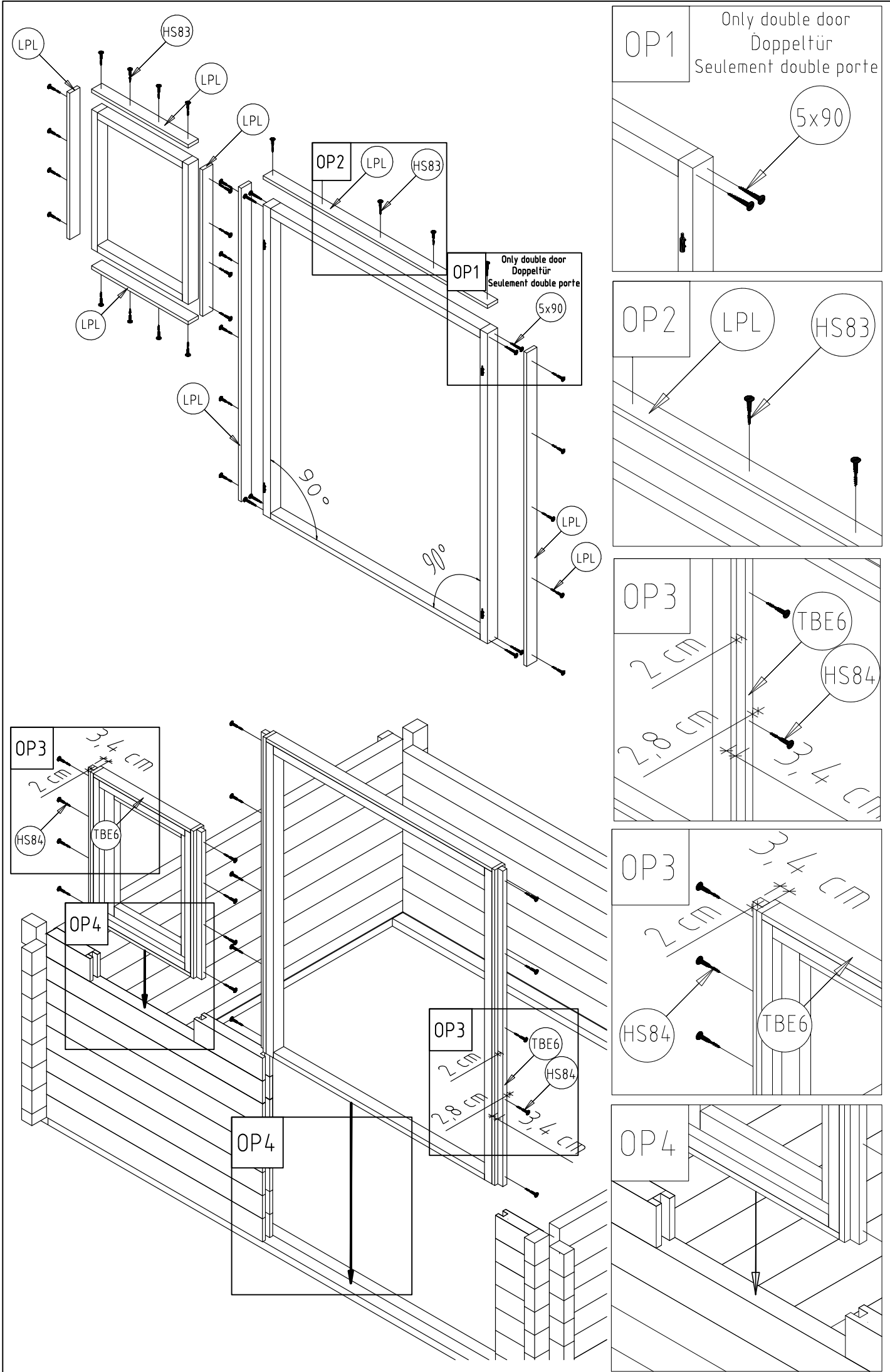

OP1 Only double door  
Doppeltür  
Seulement double porte

