

544

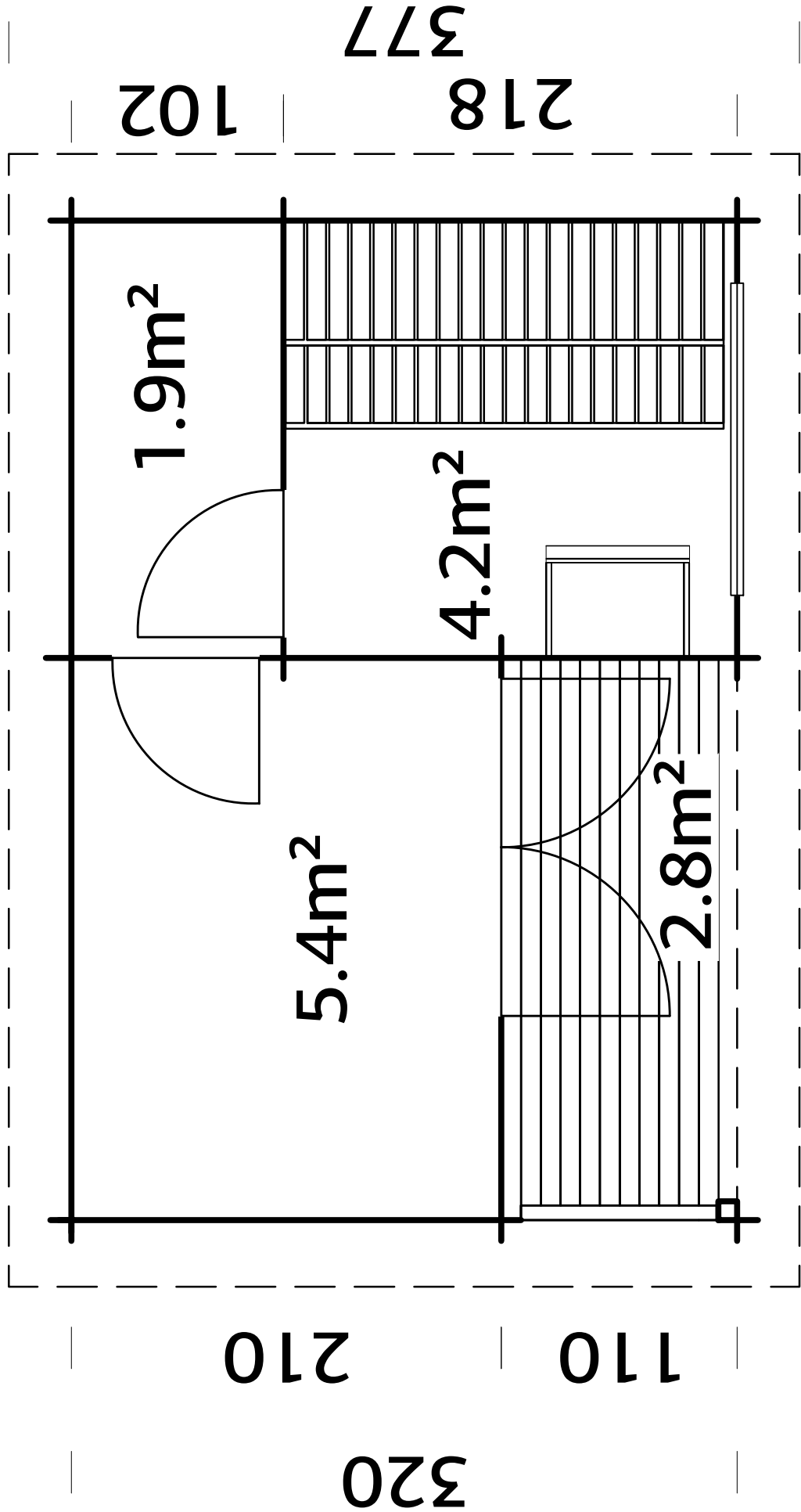

102

218
377

1.9m²

5.4m²

4.2m²

2.8m²

210

480









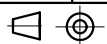











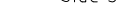

210

110



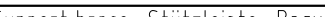





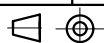











320

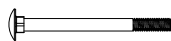
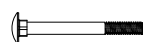
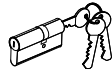
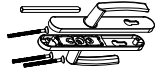

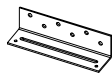





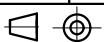



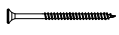

Pos	SPECIFICATION-STÜCKLISTE-NOMENCLATURE-ELEMENTI-ESPECIFICACIÓN FR44-5034	Pcs	Profile (mm)	Length (mm)
001		1	44x57	3400
002		18	44x114	3400
007		1	44x57	3400
008		50	44x114	300
009		17	44x114	2400
010		1	44x114	3400
011		1	44x57	2310
012		18	44x114	2310
016		18	44x114	5000
017		2	44x114	5200
018		2	44x114	5400
019		1	44x114	2300
020		16	44x114	1300
021		1	44x114	2300
022		12	44x114	2300
023		17	44x114	1024
024		1	44x114	2944
025		3	44x114	2800
026		18	44x114	400
W1-1		1		
W2-1		1		
W3-1		1		

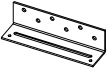

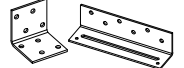
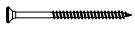

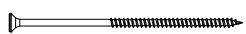
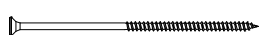
Pos	SPECIFICATION-STÜCKLISTE-NOMENCLATURE-ELEMENTI-ESPECIFICACIÓN FR44-5034	Pcs	Profile (mm)	Length (mm)
AR1	Foundation- Fundament- Fondation- Fondazione- Vigas de cimentación 	2	70x45	4790
AR2	Foundation- Fundament- Fondation- Fondazione- Vigas de cimentación 	4	70x45	459
AR3	Foundation- Fundament- Fondation- Fondazione- Vigas de cimentación 	11	70x45	3050
FB1	Floor board- Fussbodenbrett- Madrier du plancher - Tavola pavimento- Tabla de suelo 	17	120x28	2650
FB2	Floor board- Fussbodenbrett- Madrier du plancher - Tavola pavimento- Tabla de suelo 	26	120x28	2006
CnB1	Connecting board- Verbindungsbrett- Madrier de connection- Tavola di collegamento- Listón de junta 	1	90x28	690
Pst1	Post- Pfosten- Poteau- Montante- Poste 	1	90x90	2080
Sis1	Side slat- Randleiste- Baguette en bordure- Listón de borde- Listello bordo 	4	45x19	1860
Sis2	Side slat- Randleiste- Baguette en bordure- Listón de borde- Listello bordo 	4	28x28	1890
Sis3	Side slat- Randleiste- Baguette en bordure- Listón de borde- Listello bordo 	2	70x19	750
Sis4	Side slat- Randleiste- Baguette en bordure- Listón de borde- Listello bordo 	2	45x28	746
Sis5	Side slat- Randleiste- Baguette en bordure- Listón de borde- Listello bordo 	2	45x19	750
Sis6	Side slat- Randleiste- Baguette en bordure- Listón de borde- Listello bordo 	2	28x28	746
Sla1	Slat- Leiste- Baguette- Listello- Listón 	1	19x45	1620
SP1	Support brace- Stützleiste- Baguette de support- Listello di supporto- Listón de soporte 	2	32x40	2012
SP2	Support brace- Stützleiste- Baguette de support- Listello di supporto- Listón de soporte 	2	58x40	370
SP3	Support brace- Stützleiste- Baguette de support- Listello di supporto- Listón de soporte 	2	58x40	570
SP4	Support brace- Stützleiste- Baguette de support- Listello di supporto- Listón de soporte 	2	45x25	510
SP5	Support brace- Stützleiste- Baguette de support- Listello di supporto- Listón de soporte 	2	45x25	390
SP6	Support brace- Stützleiste- Baguette de support- Listello di supporto- Listón de soporte 	2	45x25	370
SP7	Support brace- Stützleiste- Baguette de support- Listello di supporto- Listón de soporte 	2	32x40	2048
PR1	Purlin- Dachpfette- Arbalétrier- Arcareccio- Correa 	3	44x120	5400
TB1-1	Terrace board- Terrassenbrett- Madrier de terrasse- Tavola terrazzo- Tabla de terraza 	11	95x19	2695
RB2-1	Roof board- Dachbrett- Madrier du toit- Tavola tetto- Tabla de tejado 	61	89x19	3750
EaE2-1	Eave edging- Dachrandbrett- Madrier en bordure du toit- Tavola bordo tetto- Tabla de valadizo 	2	16x120	3750

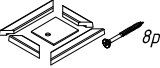

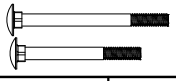
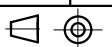
Pos	SPECIFICATION-STÜCKLISTE-NOMENCLATURE-ELEMENTI-ESPECIFICACIÓN FR44-5034	Pcs	Profile (mm)	Length (mm)
EaE6-1	Eave edging- Dachrandbrett- Madrier en bordure du toit- Tavola bordo tetto- Tabla de valadizo 	4	19x120	2720
FIB2-1	Floor beading- Fussbodenleiste- Baguette du plancher- Listello pavimento- Listón de suelo 	10	19x19	2200
RE2-1	Roof edge reinforcement- Dachrandleiste- Baguette en bordure du toit- Rinforzo bordo tetto- Refuerzo borde tejado 	2	32x40	2420
RE2-2	Roof edge reinforcement- Dachrandleiste- Baguette en bordure du toit- Rinforzo bordo tetto- Refuerzo borde tejado 	2	32x40	2980
Sis1-1	Side slat- Randleiste- Baguette en bordure- Listón de borde- Listello bordo 	4	19x70	1150
Sis1-2	Side slat- Randleiste- Baguette en bordure- Listón de borde- Listello bordo 	1	19x70	1600
Sis1-3	Side slat- Randleiste- Baguette en bordure- Listón de borde- Listello bordo 	4	19x70	2050
Sis2-1	Side slat- Randleiste- Baguette en bordure- Listón de borde- Listello bordo 	3	19x95	1750
Sis2-2	Side slat- Randleiste- Baguette en bordure- Listón de borde- Listello bordo 	2	19x95	1850
StB1-1	Storm brace- Sturmleiste- Protection contre le vent- Antivento- Protector contra tormentas 	2	25x45	2100
StB1-2	Storm brace- Sturmleiste- Protection contre le vent- Antivento- Protector contra tormentas 	2	25x45	2400
WB1-1	Wind brace- Windbrett- Madrier contre le vent- Tavola vento- Tabla contra el viento 	2	16x45	3790
Fim	-Fixing kit- Befestigungsset- Moyens de fixation- Materiale di fissaggio- Kit de fijación	1	USE	
QLA16	Adjustment bolt - Senkbolzen - Boulon de réglage - Bullone di regolamento- Perno de ajuste 	1	Pst1	
QPOYP8 x100Zn	Bolt -Schloss-schraube -Boulon- Bullone- Perno- M8x100mm PUP0 	1	Pst1	
QPOYP 8x80Zn	Bolt -Schloss-schraube -Boulon- Bullone- Perno- M8x80mm PUP0 	8	StB1-1 StB1-2	
QULS13 0x40-1	Cylinder- Zylinderschloss- Serrure a mortaiser- Serratura a cilindro- Bombin- 30.40-1 	1	TU44-121P	
QLIU3 5x92Hb	Door fittings- Türbeschlag- Ferrure- Ferramenta porta- Manilla (puerta)- QLIU35x92Hb 	1	TU44-121P	
QUN-1	Door fittings- Türbeschlag- Ferrure- Ferramenta porta- Manilla puerta- QUN-1 	2	U70-96P	
QNU35x3 5x130Zn	L-iron- Winkel- Angle -Angolo- Angulo 35x35x130 EM VN353590 	3	Louvre	
QNU40x 40x40Zn	L-iron- Winkel- Angle -Angolo- Angulo 40x40x40 	8	ARx	
QNA1 4x40Me	Nail- Nagel- Clou- Chiodo- Clavo- 1.4x40mm 	100		
QNA2 2x50Zn	Nail- Nagel- Clou- Chiodo- Clavo- 2.5x50mm 	400		
	Object name FR44-5034		Page 3/6	

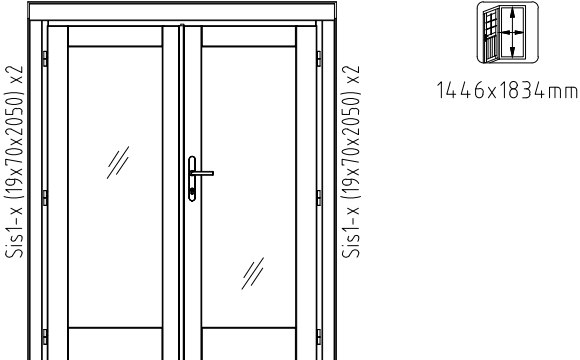
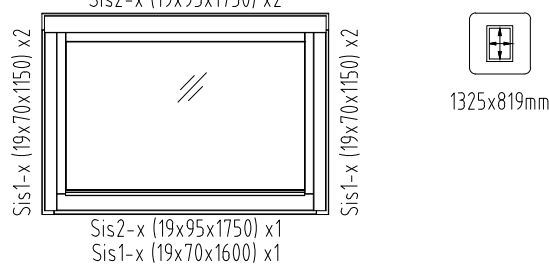
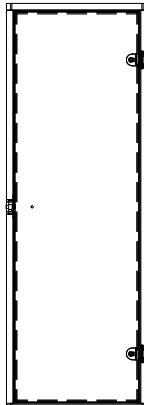
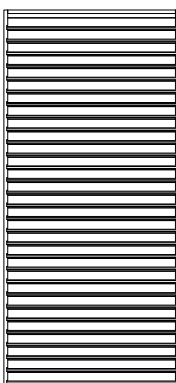
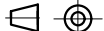
Pos	SPECIFICATION-STÜCKLISTE-NOMENCLATURE-ELEMENTI-ESPECIFICACIÓN FR44-5034	Pcs	Profile (mm)	Length (mm)
QMUk K8Zn	Nut- Schraubenmutter- Écrou- Dado- Tuerca- M8mm 	9		
QKRPP 4_2x6 5HATX	Screw- Schraube- Vis- Vite- Tornillo- 4.2x65mm 	620	TB1-1 FBx	
QKRPP4 _5x50Zn	Screw- Schraube- Vis- Vite- Tornillo- 4.5x50mm 	272	EaE2-x; WB1-1 RE2-x ; EL3 Sisx-x ;	
QKRPP4 _5x60Zn	Screw- Schraube- Vis- Vite- Tornillo- 4.5x60mm 	26	Sis2; Sis6	
QKRPP4 _5x70Zn	Screw- Schraube- Vis- Vite- Tornillo- 4.5x70mm 	64	 SP1;SP7 SP4;SP5;SP6 Slā1	
QKRPP 4x16Zn	Screw- Schraube- Vis- Vite- Tornillo- 4x16mm 	18		
QKRYp 5x40Zn	Screw- Schraube- Vis- Vite- Tornillo- 5x40mm ZnY 	100		
QKRPP5 x80ZnTX	Screw- Schraube- Vis- Vite- Tornillo- 5x80mm 	30	SP2;SP3 EL1ā,EL1B	
QKRPP 5x90Zn	Screw- Schraube- Vis- Vite- Tornillo- 5x90mm 	20	CnB1 PRx	
QKRPP6 x120Zn	Screw- Schraube- Vis- Vite- Tornillo- 6x120mm 	6	025	
QKRPP6 x150Zn	Screw- Schraube- Vis- Vite- Tornillo- 6x150mm 	22	ARx	
QKRPP 6x160 ZnTX-1	Screw- Schraube- Vis- Vite- Tornillo- 6x160mm TX-1 	6	TU44-121P	
QKA100 x100Zn	Ventilation grate- Lüftungsdeckel- Couvercle d'aération- Copertura aerazione- Embellecedor ventilación 	2	Wall 1 Wall A	
KE230	Ventilation hatch- Belüftungsluke- Trappe d'aération- Portello di ventilazione- Trampilla de ventilación KE230 	2	Wall 1 Wall A	8pcs
QSE8 x22Zn	Washer- Dichtscheibe- Joint- Rondella- Arandela- 8x22mm 	9		
	Object name FR44-5034	Page 4/6		

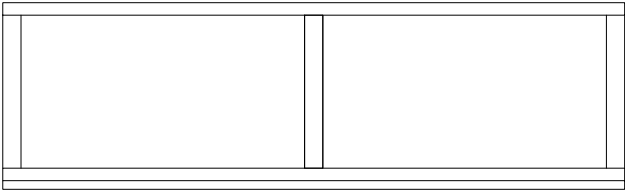
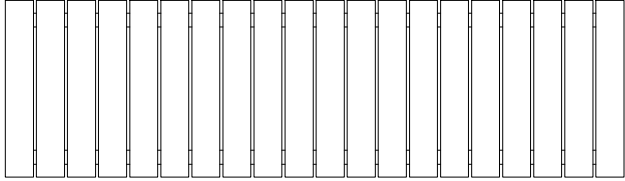
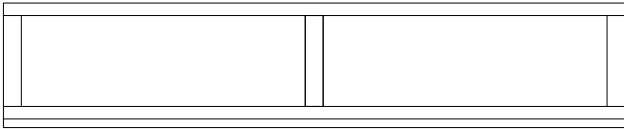
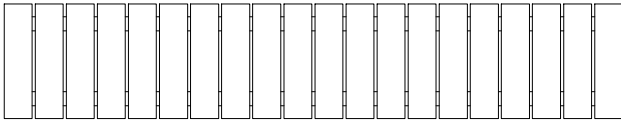
Pos	SPECIFICATION-STÜCKLISTE-NOMENCLATURE-ELEMENTI-ESPECIFICACIÓN FR44-5034	Pcs	Profile (mm)	Length (mm)
TU44-121P	<p>Door - Tür - Porte - Porta-Puerta 1610x1936</p> <p>Sis2-x (19x95x1850) x2</p>  <p>1446x1834mm</p>	1		
A44-108	<p>Window - Fenster - Fenetre - Finestra-Ventana 1490x990</p> <p>Sis2-x (19x95x1750) x2</p>  <p>1325x819mm</p> <p>Sis2-x (19x95x1750) x1 Sis1-x (19x70x1600) x1</p>	1		
U70-96P	<p>Door - Tür - Porte - Porta-Puerta 690x1890</p> 	2		
	<p>Žaluzii-1-Louvre 900x2020</p> 	1		
	Object name		Page	5/6

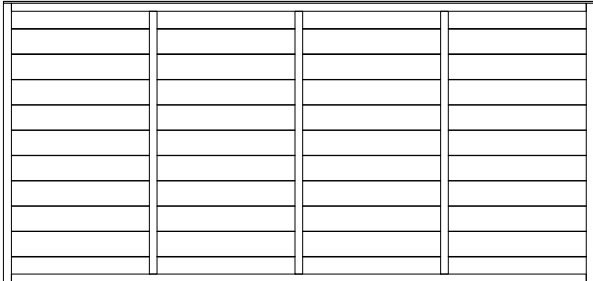
Pos	SPECIFICATION-STÜCKLISTE-NOMENCLATURE-ELEMENTI-ESPECIFICACIÓN FR44-5034	Pcs	Profile (mm)	Length (mm)
EL1a		1	600x90	2100
EL1b		1	568x47	2090
EL2a		1	400x90	2100
EL2b		1	368x47	2090
EL3		1	320x47	2000
EL4		2	995x44	2100
MMP130 x600x1200	FINNFOAM FF-PIR 30 SAUNA 30X600X1200MM	8		

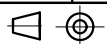

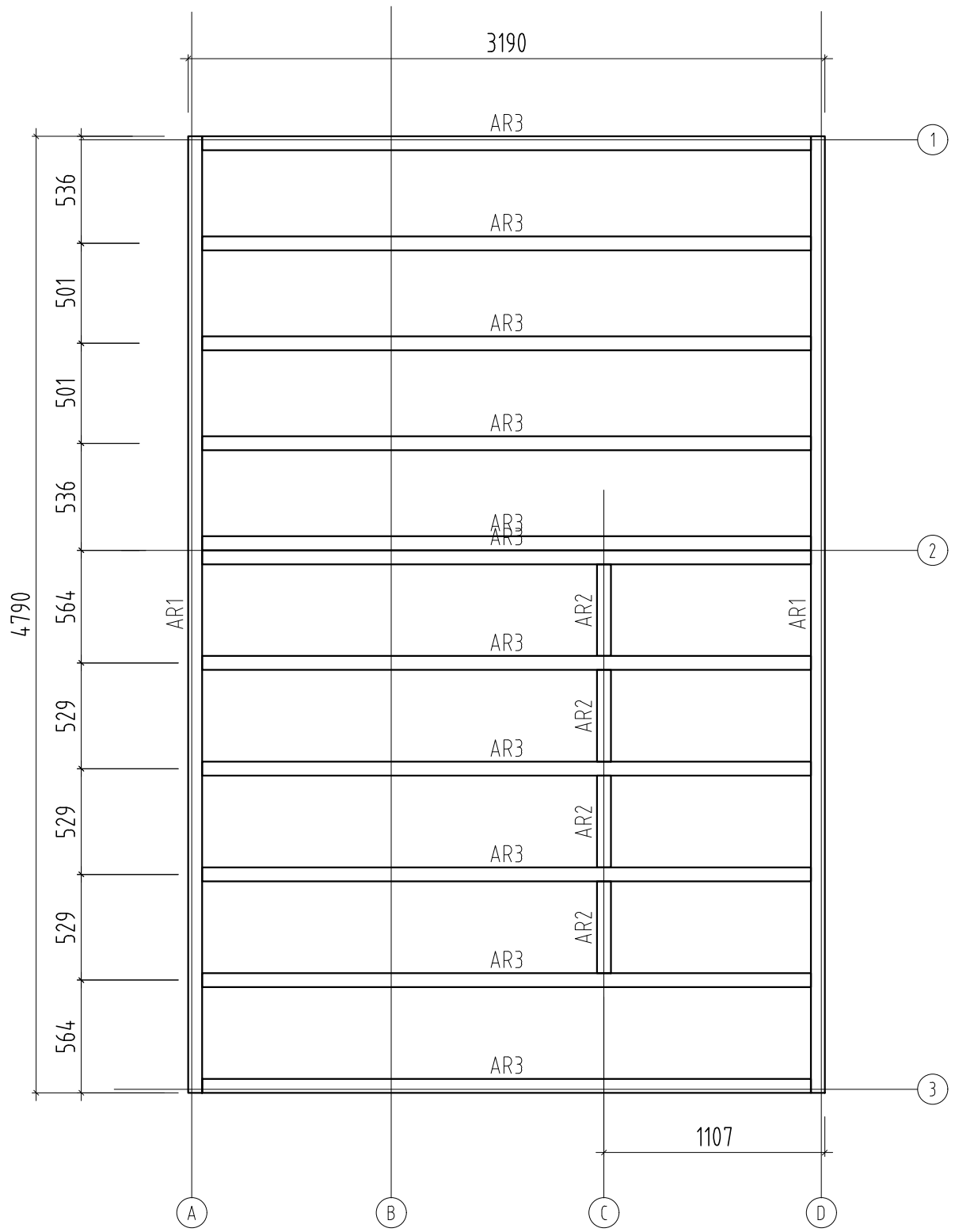

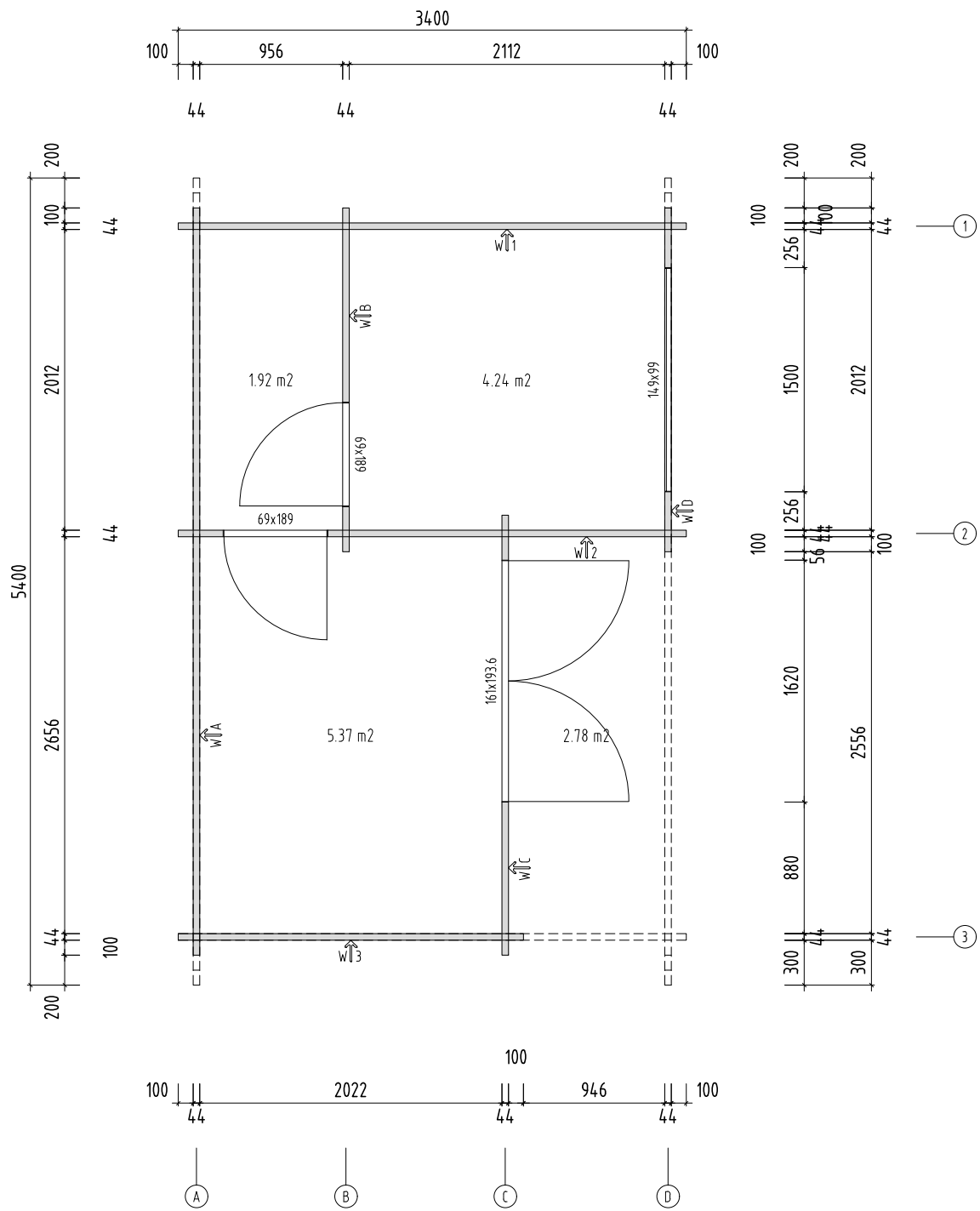

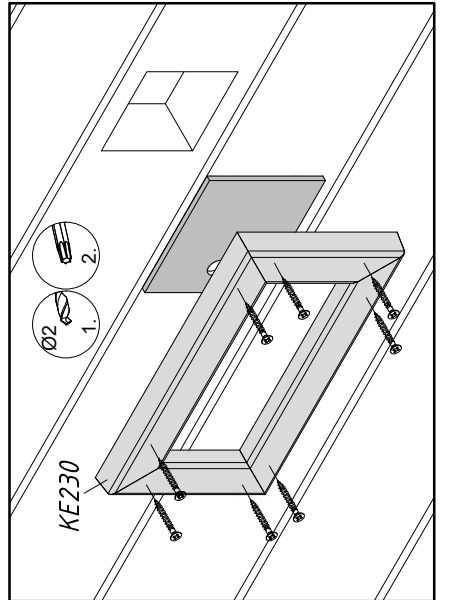
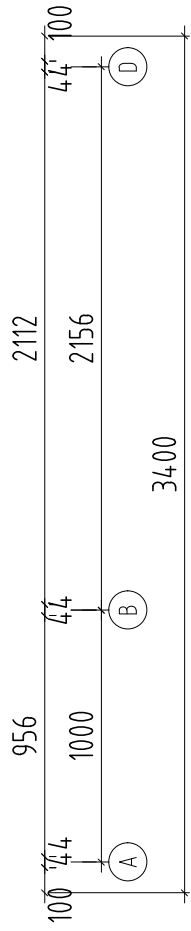
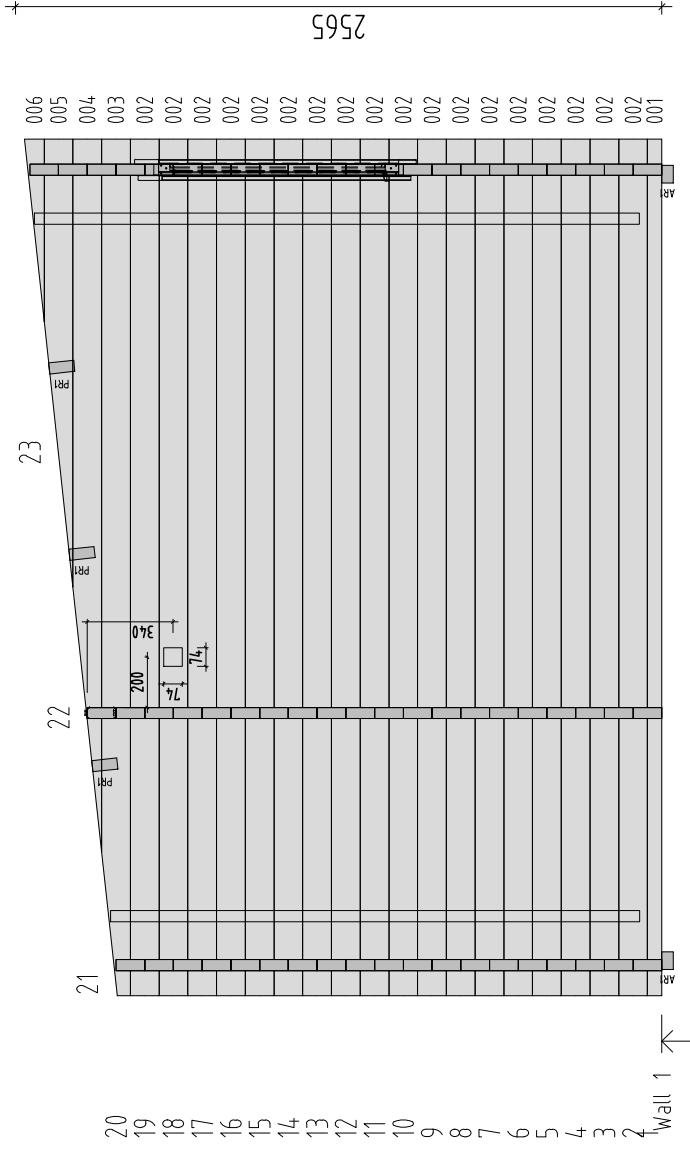

20
19
18
17
16
15
14
13
12
11
10
9
8
7
6
5
4
3
2

Wall 2

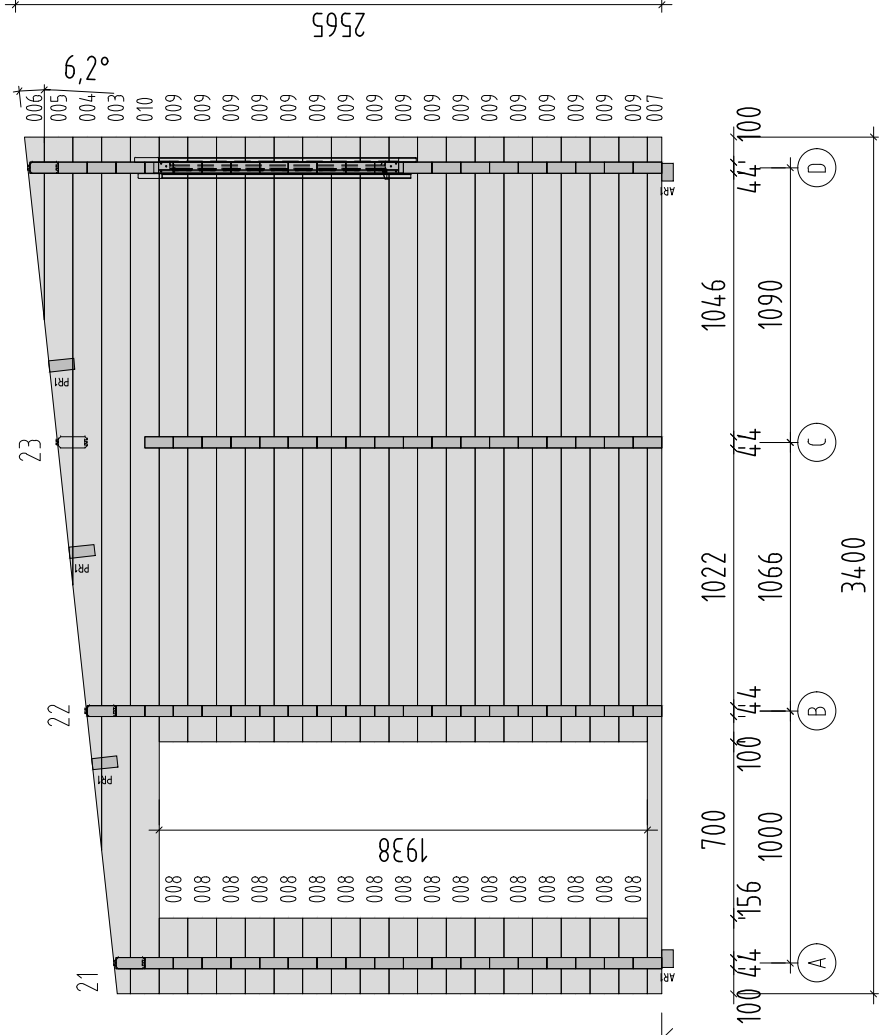

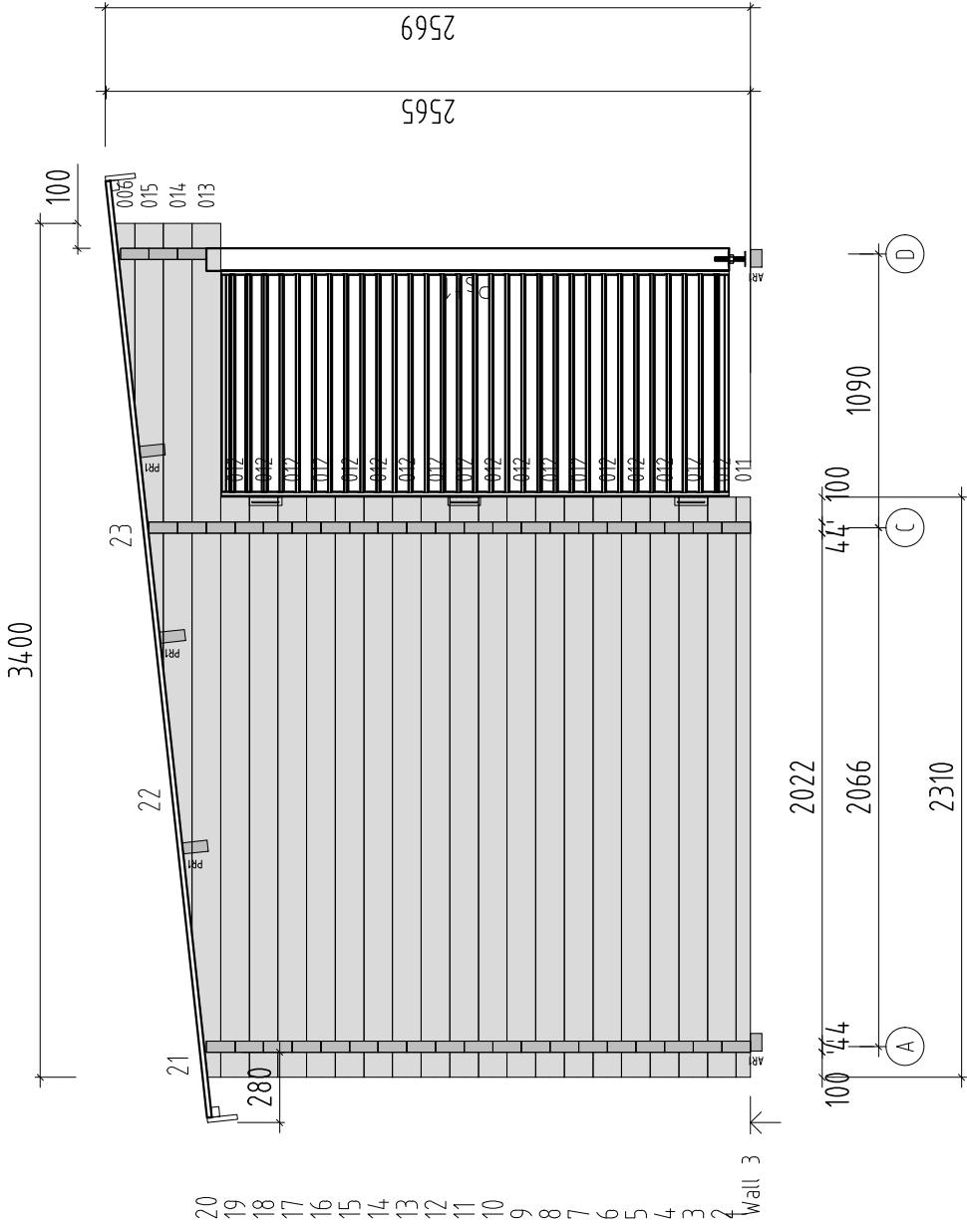

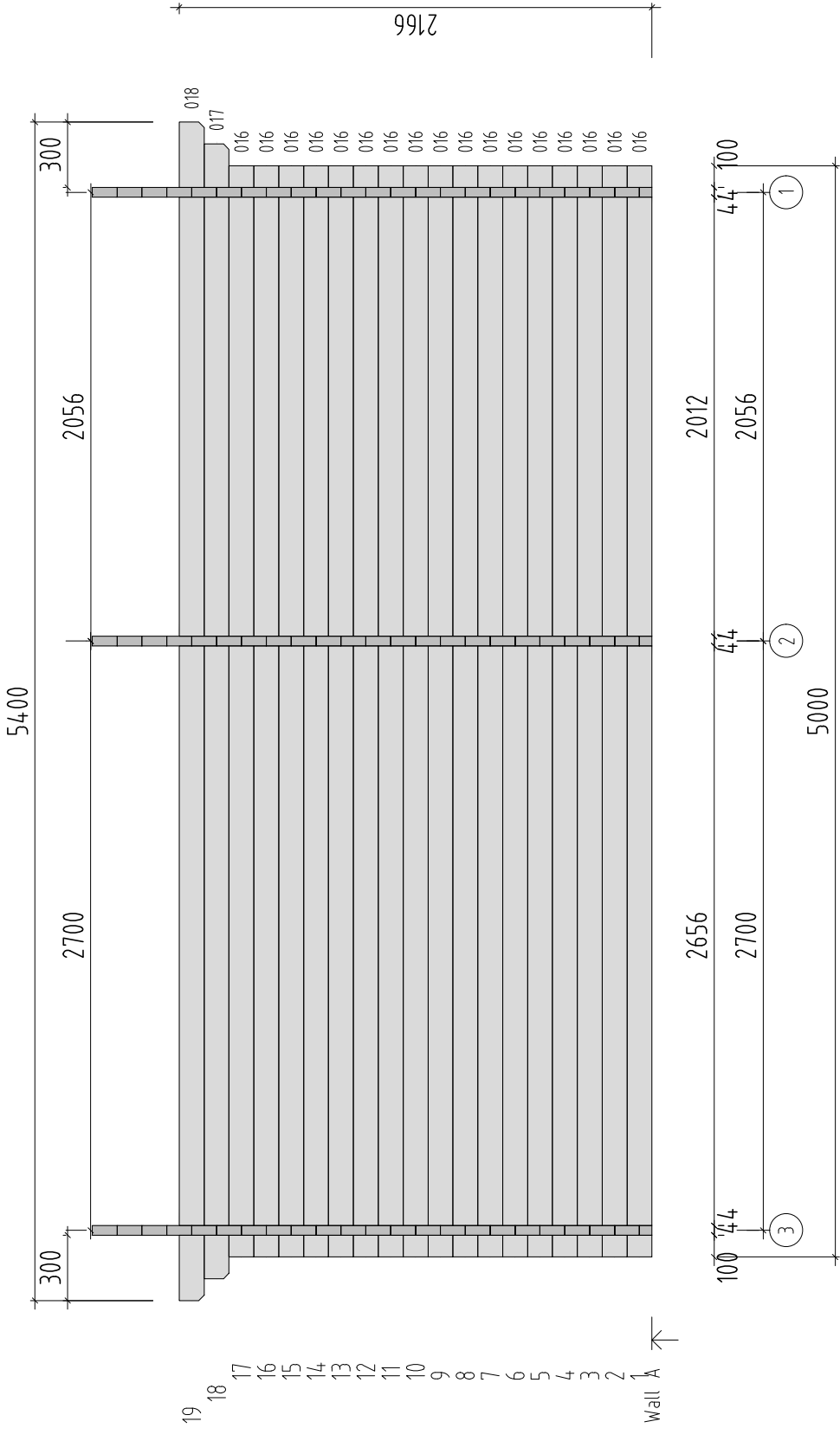

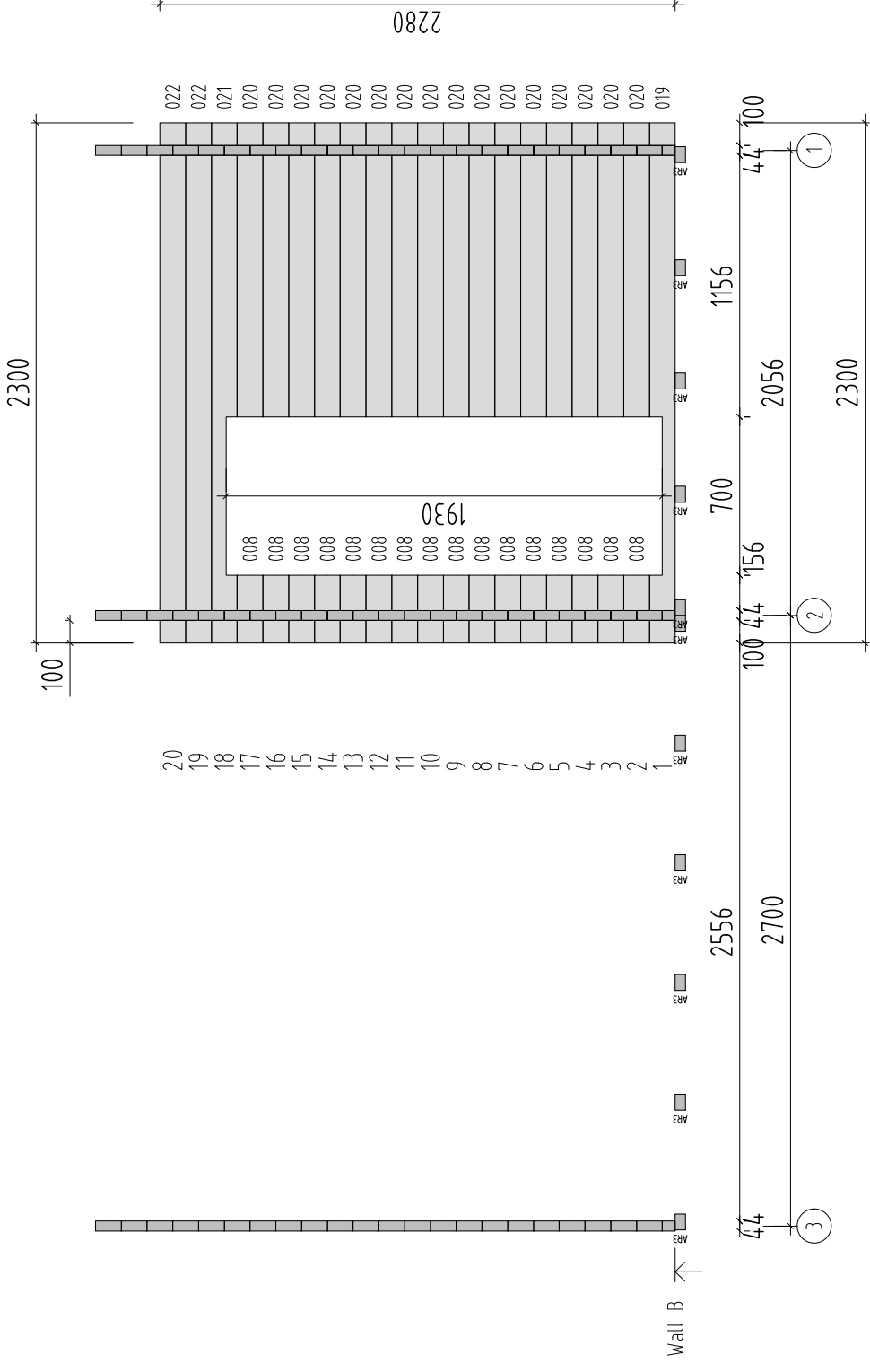

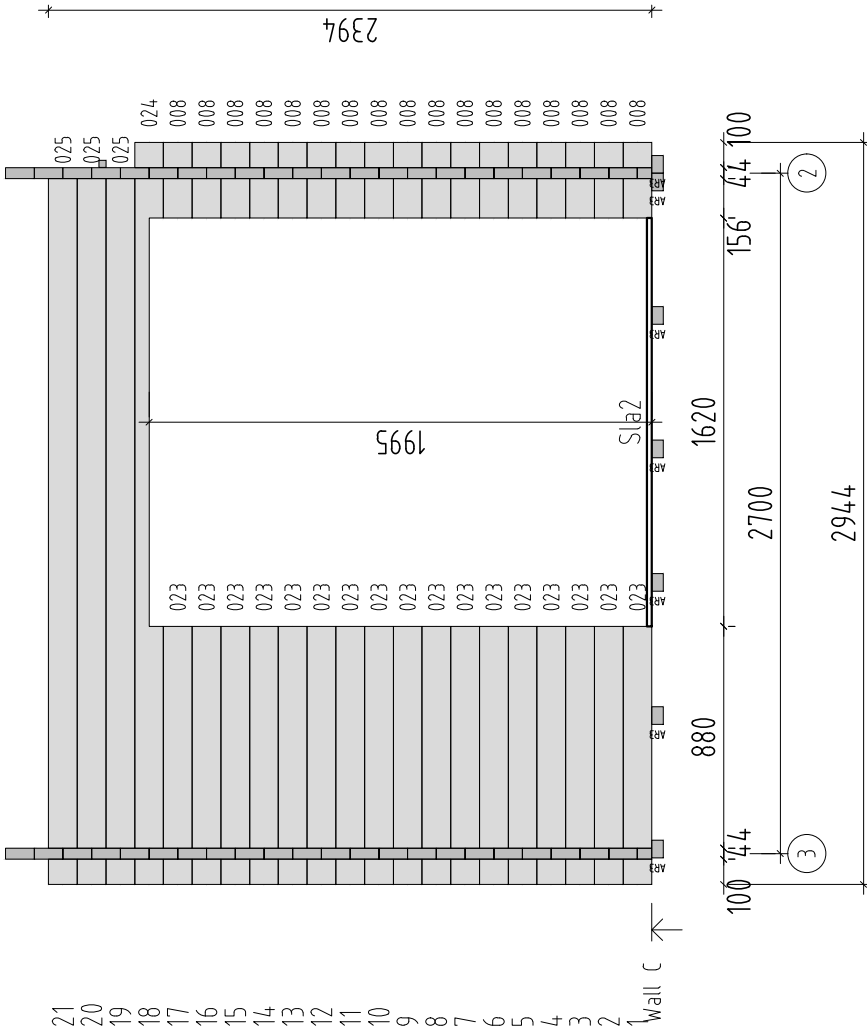

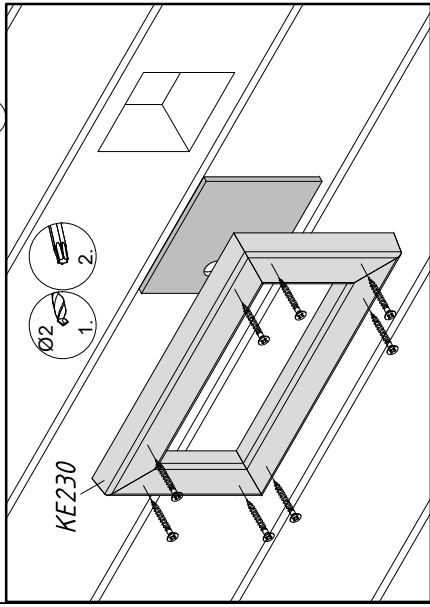
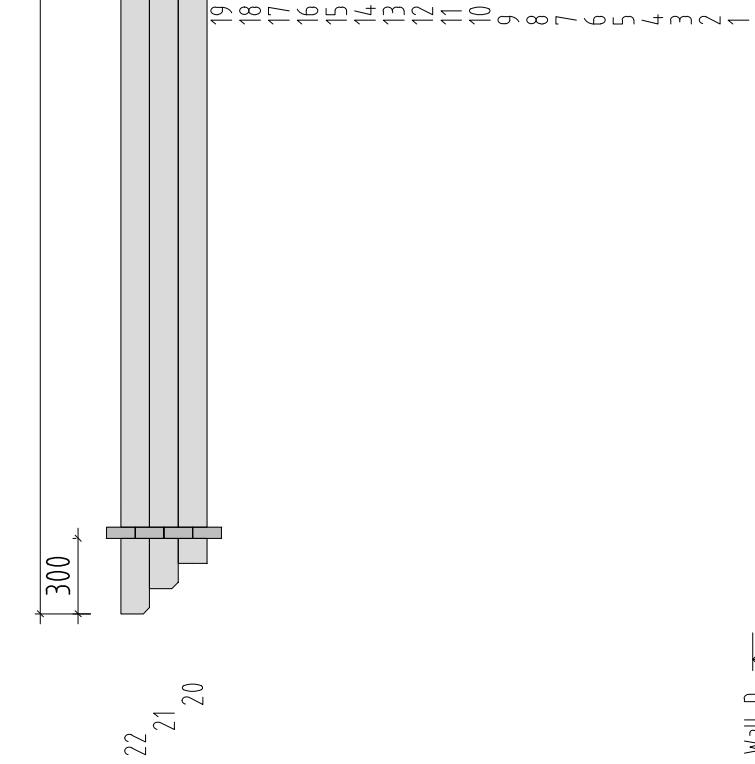
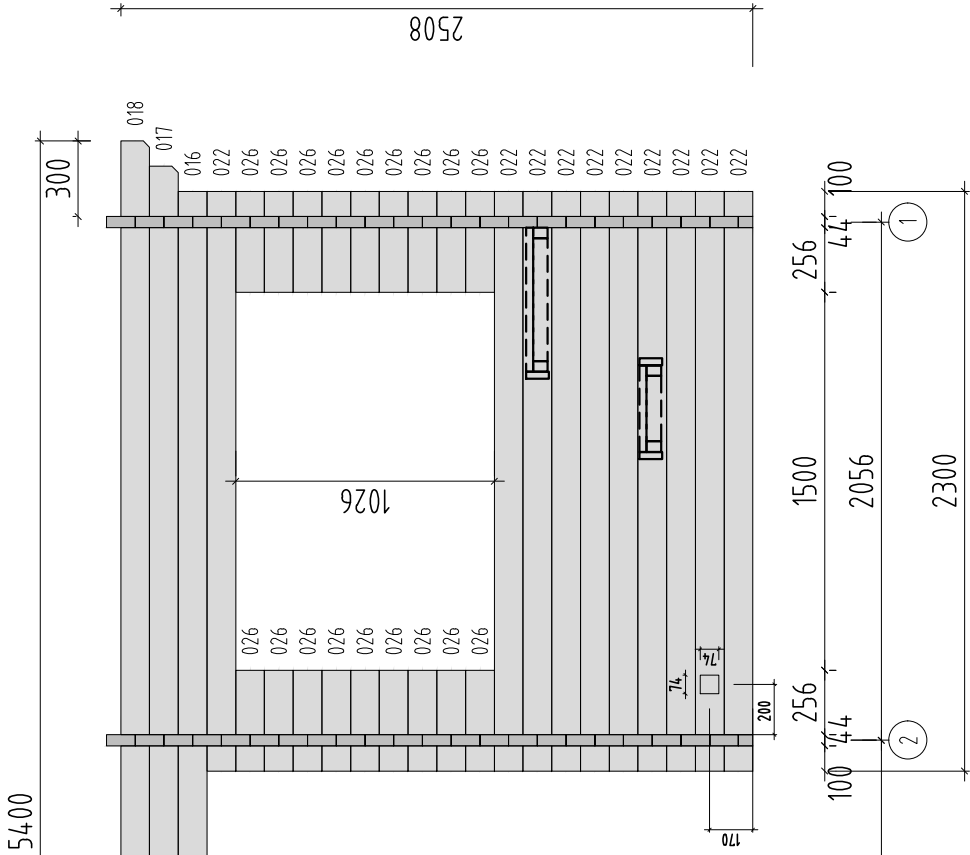

Wall D

