

102

420

920









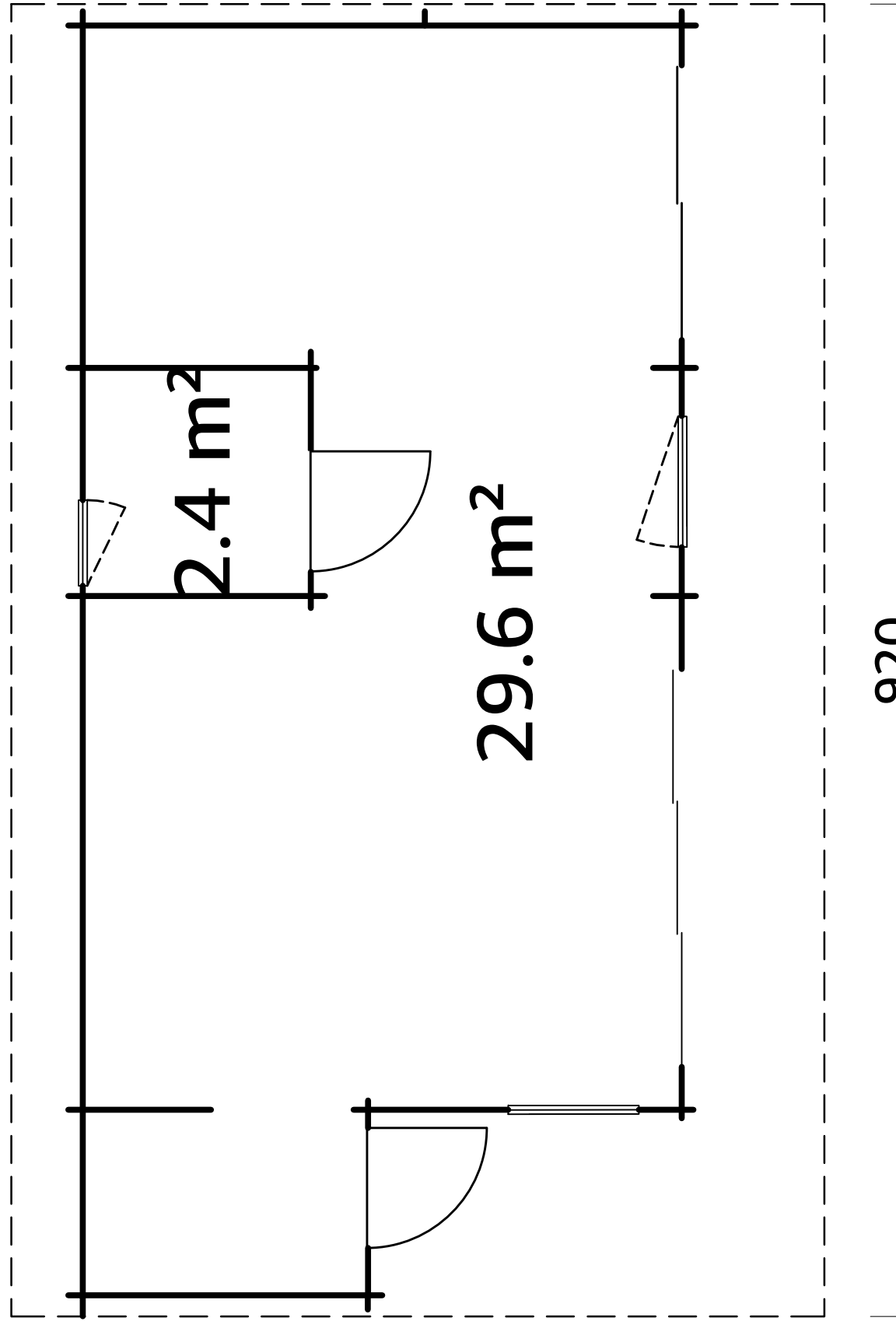

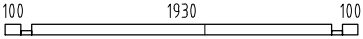
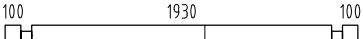
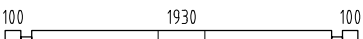
29.6 m<sup>2</sup>

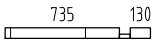
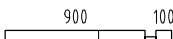
2.4 m<sup>2</sup>

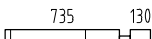
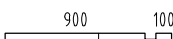
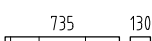

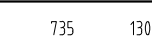
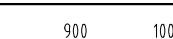
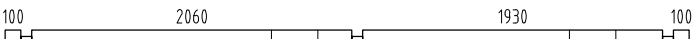



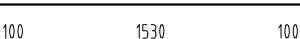
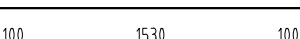
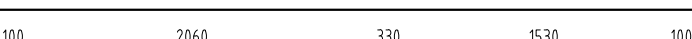
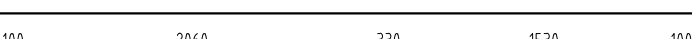
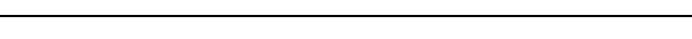
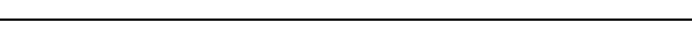
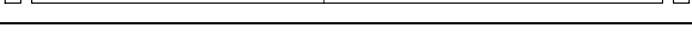

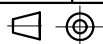

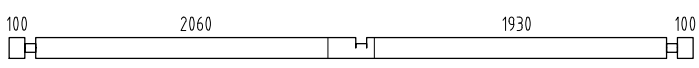
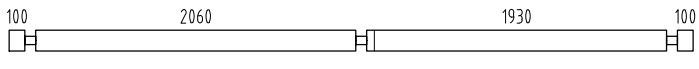

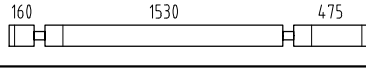

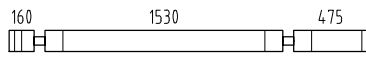
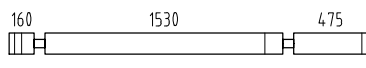
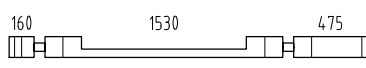
890

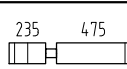
570

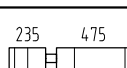

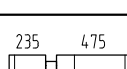
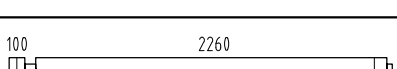
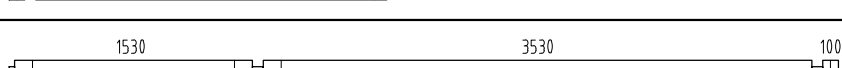
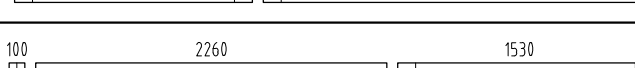
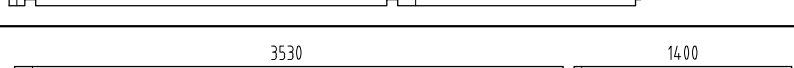
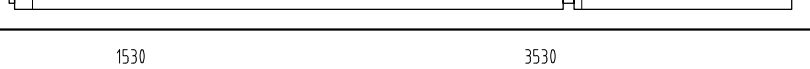
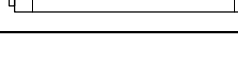
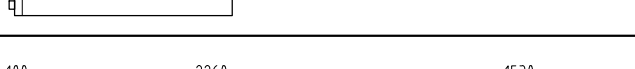
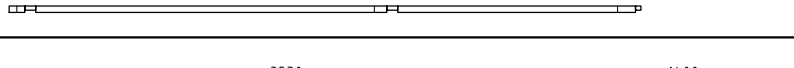



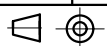

Pos	SPECIFICATION-STÜCKLISTE-NOMENCLATURE-ELEMENTI-ESPECIFICACIÓN PM70-9144	Pcs	Profile (mm)	Length (mm)
001		1	70x68	2270
002		9	70x135	2270
003		8	70x135	2270
006		1	70x68	435
007		1	70x68	935
008		1	70x68	1070
009		15	70x135	435
010		4	70x135	935
011		4	70x135	1070
012		7	70x135	935
013		7	70x135	1070
014		4	70x135	935
015		4	70x135	1070
016		1	70x135	4400
017		1	70x135	4400
020		2	70x68	270
021		2	70x68	1870
022		30	70x135	270
023		16	70x135	1870
024		14	70x135	1870
025		2	70x135	4400
026		2	70x135	4400
028		1	70x68	4400
029		8	70x135	4400
030		7	70x135	4400

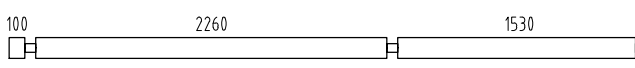
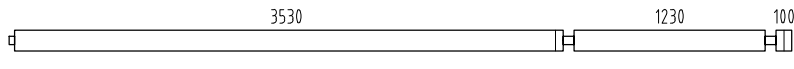
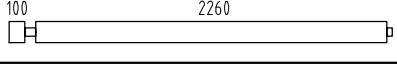
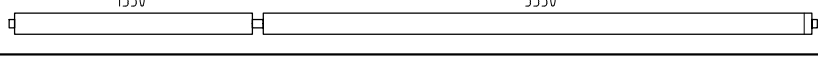
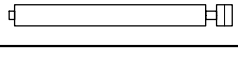
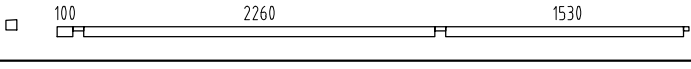
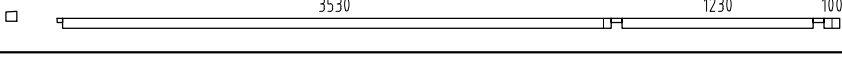

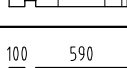

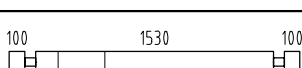
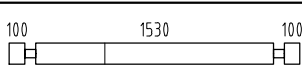
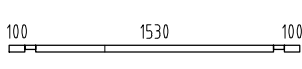
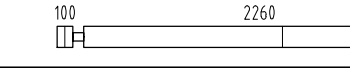
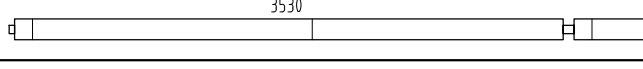
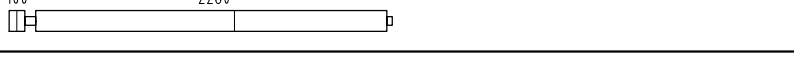
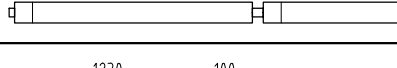
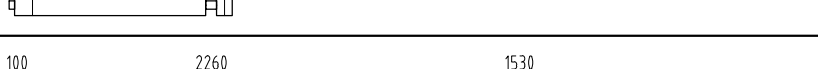
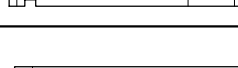
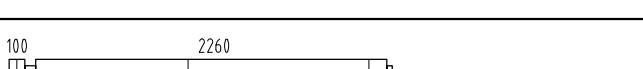
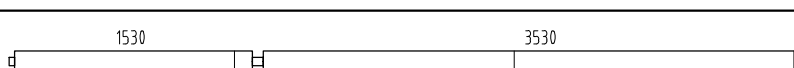
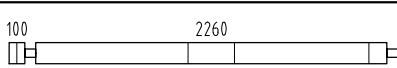

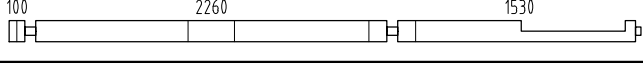

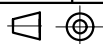

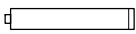
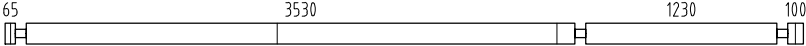
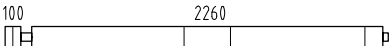
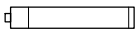
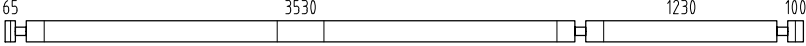
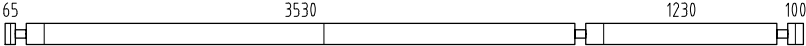

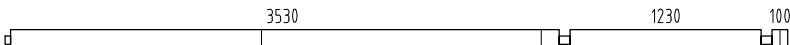
Pos	SPECIFICATION-STÜCKLISTE-NOMENCLATURE-ELEMENTI-ESPECIFICACIÓN PM70-9144	Pcs	Profile (mm)	Length (mm)
031		1	70x135	4400
032		1	70x135	4400
034		16	70x135	330
035		3	70x135	2305
036		16	70x135	435
037		2	70x135	2305
038		1	70x135	2305
039		1	70x135	2305
040		3	70x135	465
041		3	70x135	780
042		4	70x135	465
043		4	70x135	780
044		2	70x135	465
045		2	70x135	780
046		2	70x135	2465
047		1	70x135	5335
048		1	70x135	4065
049		1	70x135	5035
050		1	70x135	5200
051		1	70x135	1435
052		1	70x41	4065
053		1	70x41	5035
054		1	70x135	271
055		16	70x135	259
056		15	70x135	271



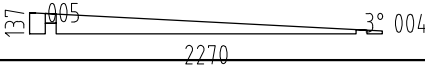
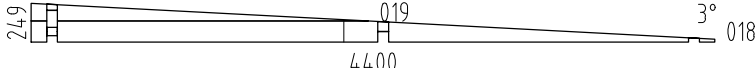
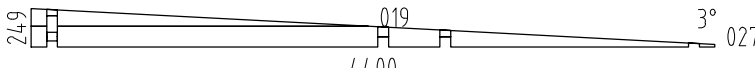
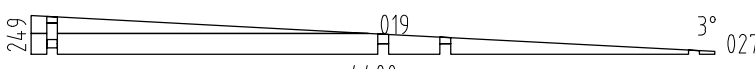
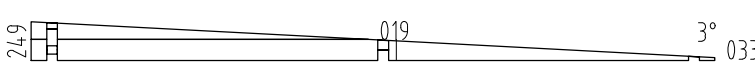

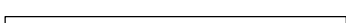



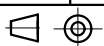



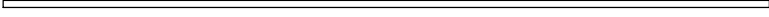

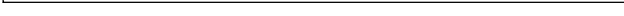









Pos	SPECIFICATION-STÜCKLISTE-NOMENCLATURE-ELEMENTI-ESPECIFICACIÓN PM70-9144	Pcs	Profile (mm)	Length (mm)
057		1	70x135	4065
058		1	70x135	5035
059		1	70x135	2465
060		1	70x135	5200
061		3	70x135	1435
062		1	70x64	4065
063		1	70x64	5035
064		5	70x135	760
065		15	70x135	265
066		7	70x135	760
067		3	70x135	760
068		1	70x135	1870
069	 LU59-5P	1	70x135	1870
070		1	70x135	1870
071		1	70x43	1870
072		1	70x135	4065
073		1	70x135	5035
074		4	70x135	2465
075		3	70x135	5200
076		4	70x135	1435
077		4	70x135	4065
078		5	70x135	5035
079		3	70x135	2465
080		2	70x135	5200
081		1	70x135	4065





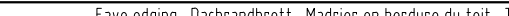



















Pos	SPECIFICATION-STÜCKLISTE-NOMENCLATURE-ELEMENTI-ESPECIFICACIÓN PM70-9144	Pcs	Profile (mm)	Length (mm)
082		1	70x135	830
083		1	70x135	5135
084		3	70x135	2465
085		3	70x135	830
086		2	70x135	5135
087		1	70x135	5135
088		1	70x135	4065
089		1	70x135	5035
090		1	70x135	5200
091		1	70x95	4065
092		1	70x95	5035
W1-1		1		
W2-1		1		
W3-1		1		
W4-1		1		
W5-1		1		
AR1	Foundation- Fundament- Fondation- Fondazione- Vigas de cimentación 	2	95x45	3960
AR2	Foundation- Fundament- Fondation- Fondazione- Vigas de cimentación 	1	95x45	3630
AR3	Foundation- Fundament- Fondation- Fondazione- Vigas de cimentación 	8	70x45	2195
AR4	Foundation- Fundament- Fondation- Fondazione- Vigas de cimentación 	8	70x45	1460
AR5	Foundation- Fundament- Fondation- Fondazione- Vigas de cimentación 	8	70x45	3465













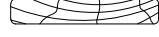
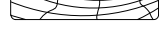







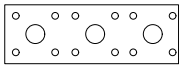
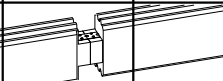

Pos	SPECIFICATION-STÜCKLISTE-NOMENCLATURE-ELEMENTI-ESPECIFICACIÓN PM70-9144	Pcs	Profile (mm)	Length (mm)
AR6	Foundation- Fundament- Fondation- Fondazione- Vigas de cimentación 	1	95x45	3795
AR7	Foundation- Fundament- Fondation- Fondazione- Vigas de cimentación 	1	95x45	4860
AR8	Foundation- Fundament- Fondation- Fondazione- Vigas de cimentación 	4	70x45	1205
AR9	Foundation- Fundament- Fondation- Fondazione- Vigas de cimentación 	1	95x45	4930
AR10	Foundation- Fundament- Fondation- Fondazione- Vigas de cimentación 	1	95x45	1870
AR11	Foundation- Fundament- Fondation- Fondazione- Vigas de cimentación 	2	95x45	4000
AR12	Foundation- Fundament- Fondation- Fondazione- Vigas de cimentación 	4	70x45	4000
CoB1	Covering board- Deckbrett- Madrier de couverture- Tavola di copertura- Listón de cubierta 	4	70x16	600
CoB2	Covering board- Deckbrett- Madrier de couverture- Tavola di copertura- Listón de cubierta 	4	70x16	1200
CoB3	Covering board- Deckbrett- Madrier de couverture- Tavola di copertura- Listón de cubierta 	1	70x28	2031
CoB4	Covering board- Deckbrett- Madrier de couverture- Tavola di copertura- Listón de cubierta 	2	70x28	2030
CoB5	Covering board- Deckbrett- Madrier de couverture- Tavola di copertura- Listón de cubierta 	1	70x28	2030
CoB6	Covering board- Deckbrett- Madrier de couverture- Tavola di copertura- Listón de cubierta 	4	70x16	2049
CoB7	Covering board- Deckbrett- Madrier de couverture- Tavola di copertura- Listón de cubierta 	8	70x28	2050
CoB8	Covering board- Deckbrett- Madrier de couverture- Tavola di copertura- Listón de cubierta 	1	95x28	1109
CoB9	Covering board- Deckbrett- Madrier de couverture- Tavola di copertura- Listón de cubierta 	1	95x28	2010
CoB10	Covering board- Deckbrett- Madrier de couverture- Tavola di copertura- Listón de cubierta 	2	95x28	2857
CoB11	Covering board- Deckbrett- Madrier de couverture- Tavola di copertura- Listón de cubierta 	2	95x16	740
CoB12	Covering board- Deckbrett- Madrier de couverture- Tavola di copertura- Listón de cubierta 	4	95x16	1130
CoB13	Covering board- Deckbrett- Madrier de couverture- Tavola di copertura- Listón de cubierta 	1	19x95	740
CoB14	Covering board- Deckbrett- Madrier de couverture- Tavola di copertura- Listón de cubierta 	1	19x95	1130
CoB15	Covering board- Deckbrett- Madrier de couverture- Tavola di copertura- Listón de cubierta 	1	95x16	2010
CoB16	Covering board- Deckbrett- Madrier de couverture- Tavola di copertura- Listón de cubierta 	1	95x16	1110
EaE1	Eave edging- Dachrandbrett- Madrier en bordure du toit- Tavola bordo tetto- Tabla de valadizo 	1	120x28	3256
EaE2	Eave edging- Dachrandbrett- Madrier en bordure du toit- Tavola bordo tetto- Tabla de valadizo 	1	120x28	5844



Pos	SPECIFICATION-STÜCKLISTE-NOMENCLATURE-ELEMENTI-ESPECIFICACIÓN PM70-9144	Pcs	Profile (mm)	Length (mm)
EaE3	Eave edging- Dachrandbrett- Madrier en bordure du toit- Tavola bordo tetto- Tabla de valadizo 	2	70x28	3256
EaE4	Eave edging- Dachrandbrett- Madrier en bordure du toit- Tavola bordo tetto- Tabla de valadizo 	2	70x28	5844
RoR1	Rafter- Sparre- Chevron- Trave- Cabrio 	20	140x44	5756
RoR2	Rafter- Sparre- Chevron- Trave- Cabrio 	8	140x44	4500
Sis1	Side slat- Randleiste- Baguette en bordure- Listón de borde- Listello bordo 	2	34x70	600
Sis2	Side slat- Randleiste- Baguette en bordure- Listón de borde- Listello bordo 	2	34x70	1200
Sis3	Side slat- Randleiste- Baguette en bordure- Listón de borde- Listello bordo 	2	34x70	2030
Sis4	Side slat- Randleiste- Baguette en bordure- Listón de borde- Listello bordo 	6	34x70	2050
Sis5	Side slat- Randleiste- Baguette en bordure- Listón de borde- Listello bordo 	1	34x70	668
Sis6	Side slat- Randleiste- Baguette en bordure- Listón de borde- Listello bordo 	1	34x70	1038
Sis7	Side slat- Randleiste- Baguette en bordure- Listón de borde- Listello bordo 	1	34x70	1938
Sis8	Side slat- Randleiste- Baguette en bordure- Listón de borde- Listello bordo 	2	34x70	1058
Sla1	Slat- Leiste- Baguette- Listello- Listón 	1	28x70	1059
Sla2	Slat- Leiste- Baguette- Listello- Listón 	1	28x70	1039
Sla3	Slat- Leiste- Baguette- Listello- Listón 	1	28x70	1939
Sla4	Slat- Leiste- Baguette- Listello- Listón 	1	28x70	2787
TP1	Tender post- Tenderleiste- T-poste- Rinforzo- Refuerzo 	2	28x28	520
TP2	Tender post- Tenderleiste- T-poste- Rinforzo- Refuerzo 	2	28x28	1120
TP3	Tender post- Tenderleiste- T-poste- Rinforzo- Refuerzo 	8	28x28	2050
2FB3-1	Floor board- Fussbodenbrett- Madrier du plancher - Tavola pavimento- Tabla de suelo 	66+1	114x28	4054
2FB3-2	Floor board- Fussbodenbrett- Madrier du plancher - Tavola pavimento- Tabla de suelo 	12+1	114x28	1924
RB2-1	Roof board- Dachbrett- Madrier du toit- Tavola tetto- Tabla de tejado 	65+1	89x19	5844

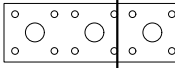

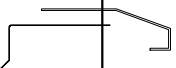
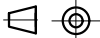





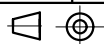

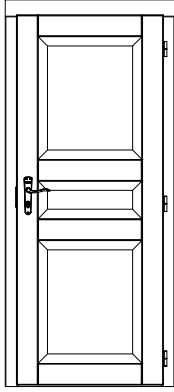



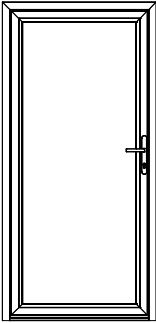

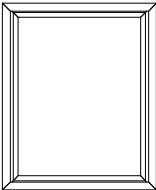
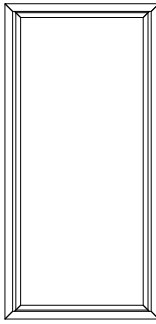
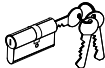
Pos	SPECIFICATION-STÜCKLISTE-NOMENCLATURE-ELEMENTI-ESPECIFICACIÓN PM70-9144		Pcs	Profile (mm)	Length (mm)
RB2-2	Roof board- Dachbrett- Madrier du toit- Tavola tetto- Tabla de tejado		65+1	89x19	3256
TB3-1	Ceiling board- Dachbodenbrett- Madrier du Grenier- Tavola soffitta- Tabla de techo		15+2	95x16	5844
TB3-2	Ceiling board- Dachbodenbrett- Madrier du Grenier- Tavola soffitta- Tabla de techo		15+2	95x16	3256
TB3-3	Ceiling board- Dachbodenbrett- Madrier du Grenier- Tavola soffitta- Tabla de techo		27+1	95x16	1400
TB3-4	Ceiling board- Dachbodenbrett- Madrier du Grenier- Tavola soffitta- Tabla de techo		59+2	95x16	100
FIB3-1	Floor beading- Fussbodenleiste- Baguette du plancher- Listello pavimento- Listón de suelo		20	19x45	1600
QT140-1	Seal- Dichtung- Joint d'isolation- Guarnizione- Burlete- QTI40		4	A51-13 U51-5 A51-14 A51-15	LU59-5P LU104-5P
StS1	Stabilizing stick- Stabilisierungsstock- Baton équilibrant- Bastone stabilizzatore- Palo estabilizador		108	16x16	360
StS2	Stabilizing stick- Stabilisierungsstock- Baton équilibrant- Bastone stabilizzatore- Palo estabilizador		6	16x16	290
StS3	Stabilizing stick- Stabilisierungsstock- Baton équilibrant- Bastone stabilizzatore- Palo estabilizador		1	16x16	265
StS4	Stabilizing stick- Stabilisierungsstock- Baton équilibrant- Bastone stabilizzatore- Palo estabilizador		4	16x16	225
StS5	Stabilizing stick- Stabilisierungsstock- Baton équilibrant- Bastone stabilizzatore- Palo estabilizador		5	16x16	180
StS6	Stabilizing stick- Stabilisierungsstock- Baton équilibrant- Bastone stabilizzatore- Palo estabilizador		2	16x16	130
QLI2 5x1_0	Connection tape -Verbindungsband für Bohlen -Ruban de connection -Nastro di connessione- Cinta de conexion 1x25x60 mm		25		
QKA85	Covering cap - Abdeckkappe - Couvercle - Copertura- Cubierta		1	054	
QLIUY-1	Door fittings- Türbeschlag- Ferrure- Ferramenta porta- Manilla (puerta)- QLIUY-1		1	U71-1P	
QVKA	Door fittings- Türbeschlag- Ferrure- Ferramenta porta- Manilla (puerta)- QVKA		1	U71-1P	
QNU20 x20x40	L-iron- Winkel- Angle -Angolo- Angulo 20x20x40		26	AR1...12 + 006	007,016
QNA2 2x50Zn	Nail- Nagel- Clou- Chiodo- Clavo- 2.5x50mm		1300	RB2-1 RB2-2	
QNA3 x70Zn	Nail- Nagel- Clou- Chiodo- Clavo- 3x70mm		800	2FB3-1 2FB3-2	
QNA4 x40Zn	Nail- Nagel- Clou- Chiodo- Clavo- 4x40mm- EM72801		200		
QNA2 x16Zn	Roofnail- Dachpappnagel- Clou pour carton bitumé- Chiodo di cartone catramato- Tachuela fieltro tejado- 2.0x16mm		20		
	Object name PM70-9144			Page	7/13





Pos	SPECIFICATION-STÜCKLISTE-NOMENCLATURE-ELEMENTI-ESPECIFICACIÓN PM70-9144	Pcs	Profile (mm)	Length (mm)
QKRPP3 _5x50Zn	Screw- Schraube- Vis- Vite- Tornillo- 3.5x50mm	1055	CoB1...16 Sla1...4 EaE1...4 TP1...3 Sis1...8 WB1...3	TB3-1...4 FLB3-1
QKRPP4 _5x70Zn	Screw- Schraube- Vis- Vite- Tornillo- 4.5x70mm	160	RoR2	
QKRK K4 8 x28MU	Screw- Schraube- Vis- Vite- Tornillo- 4.8x28mm MU	110		
QKRYP5 x40ZnTX	Screw- Schraube- Vis- Vite- Tornillo- 5x40mm	200		
QKRYP 5x40Zn	Screw- Schraube- Vis- Vite- Tornillo- 5x40mm ZnY	32	LU104- LU59-5 U51-5	A51-13 A51-14 A51-15
QKRYP 5x60Zn	Screw- Schraube- Vis- Vite- Tornillo- 5x60mm ZnY	50	LU104- LU59-5 U51-5	A51-13 A51-14 A51-15
QKRPP 6x160 ZnTX-1	Screw- Schraube- Vis- Vite- Tornillo- 6x160mm TX-1	140	AR1... 12	
QP40x30 x1109MU	Water gutter- Wasserleiste- Rejet d'eau- Protección de lluvia- Protezione dalla pioggia- QP40x30x1109	1	U51-5	
QP40x30 x1128MU	Water gutter- Wasserleiste- Rejet d'eau- Protección de lluvia- Protezione dalla pioggia- QP40x30x1128	2	A51-15 A51-14	
QP40x30 x2010MU	Water gutter- Wasserleiste- Rejet d'eau- Protección de lluvia- Protezione dalla pioggia- QP40x30x2010	1	LU104-	
QP40 x30x 2858MU	Water gutter- Wasserleiste- Rejet d'eau- Protección de lluvia- Protezione dalla pioggia- QP40x30x2858	1	LU59-5	
QP40x3 0x740MU	Water gutter- Wasserleiste- Rejet d'eau- Protección de lluvia- Protezione dalla pioggia- QP40x30x740	1	A51-13	
QP151 x52 4 x2000MU	Water gutter- Wasserleiste- Rejet d'eau- Protección de lluvia- Protezione dalla pioggia- QP151x52_4x2000MU	18		
QKRYP8 x260Zn	Screw- Schraube- Vis- Vite- Tornillo- 8x260mm ZnY	60	RoR1	
KL1	Threaded rod- Gewindestangen- Barre fileté- Asta filettata- Varilla roscada M10	6		2000
KL2	Threaded rod- Gewindestangen- Barre fileté- Asta filettata- Varilla roscada M10	2		656
KL3	Threaded rod- Gewindestangen- Barre fileté- Asta filettata- Varilla roscada M10	2		544
KL4	Threaded rod- Gewindestangen- Barre fileté- Asta filettata- Varilla roscada M10	2		440
QMUK K10ZN	Nut- Schraubenmutter- Écrou- Dado- Tuerca- M10mm	6		
QSE10 X30ZN	Washer- Dichtscheibe- Joint- Rondella- Arandela- 10x30mm	6		
QMUJ 10ZN	Extension nut- Verlängerungsmutter- Écrou rallonge- Dado di prolunga- Tuerca de extensión- JM10	6		
QMUP L10ZN	Top nut- Schweissmutter mit Flansch- Ecrou a souder- Dado a saldare- Tuerca soldable- M10	6		
QLY-A CVG45Z	Window fittings- Fenstergriff- Poigne de la fenêtre- Maniglia finestra- Manilla- QLY-ACVG45Z	3		

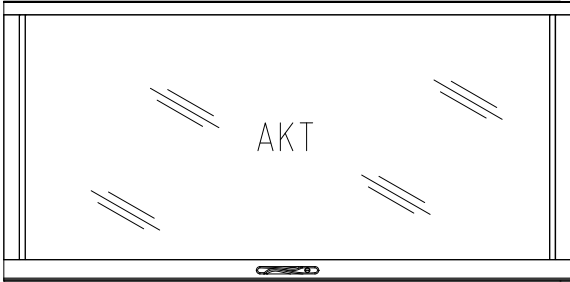
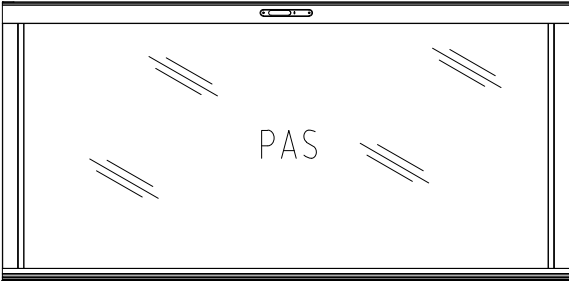
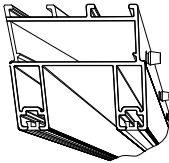
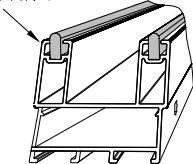
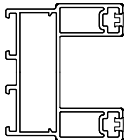

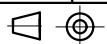

Pos	SPECIFICATION-STÜCKLISTE-NOMENCLATURE-ELEMENTI-ESPECIFICACIÓN PM70-9144	Pcs	Profile (mm)	Length (mm)
U71-1P	Door - Tür - Porte - Porta-Puerta 835x2023   735x1954mm	1		
A51-13 V-7016	Window - Fenster - Fenetre - Finestra-Ventana 600x600  500x500mm 	1		
U51-5 P-7016	Door - Tür - Porte - Porta-Puerta 990x2050  874x1986mm 	1		
A51-14 P-7016	Window - Fenster - Fenetre - Finestra-Ventana 990x1200  890x1100mm 	1		
A51-1 5-7016	Window - Fenster - Fenetre - Finestra-Ventana 990x2050 	1		
QLY- LWB02	Cylinder- Zylinderschloss- Serrure a mortaiser- Serratura a cilindro- Bombin- QLY-LWB02 		1	
QLY-A CWKS92	Door fittings- Türbeschlag- Ferrure- Ferramenta porta- Manilla (puerta)- QLY-ACWKS92 		1	
QLY-A CMAS29	Window fittings- Fenstergriff- Poigne de la fenêtre- Maniglia finestra- Manilla- QLY-ACMAS29 		2	
QLY-A CMAS33	Window fittings- Fenstergriff- Poigne de la fenêtre- Maniglia finestra- Manilla- QLY-ACMAS33 		2	
 	Object name PM70-9144		Page	9/13

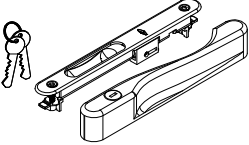
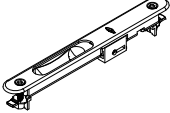
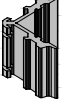
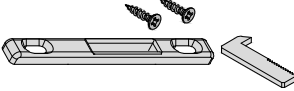
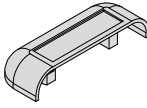
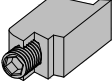
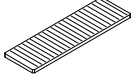
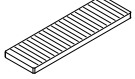
Pos	SPECIFICATION-STÜCKLISTE-NOMENCLATURE-ELEMENTI-ESPECIFICACIÓN LU59-5P-7016	4/5	Pcs	Profile (mm)	Length (mm)
A-2			1	916x42	1968
B-2			1	916x42	1968
SL8110 S-1			1	59x50	1870
SL8110 S-2	<p data-bbox="550 1214 715 1245">QLY-VG53/AN 1</p> 		1	59x50	1870
SL8110 S-3			2	59x50	2050
QLY-SL076S-1			1		1870



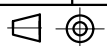

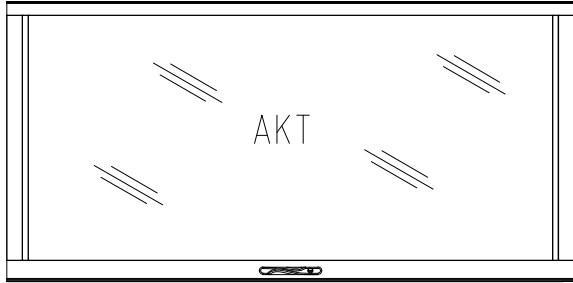
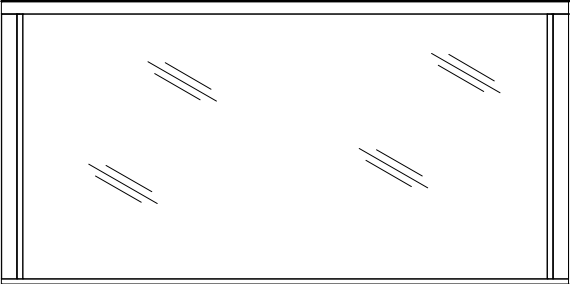
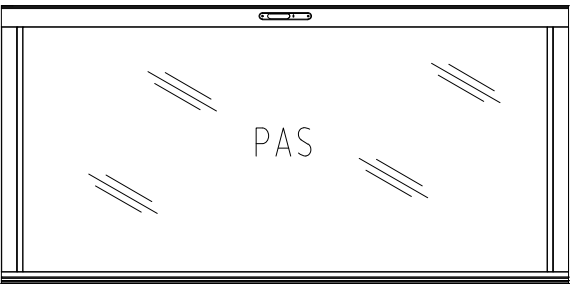
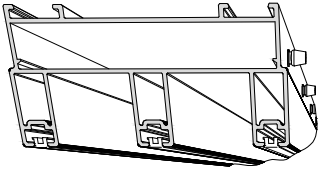
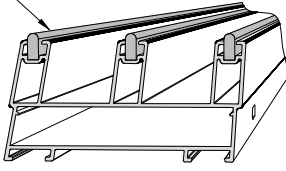
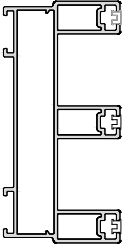

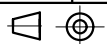

Pos	SPECIFICATION-STÜCKLISTE-NOMENCLATURE-ELEMENTI-ESPECIFICACIÓN LU59-5P-7016	5/5	Pcs	Profile (mm)	Length (mm)
QLY- ACSL243			1		
QLY- ACSL240			1		
QLY- ACSL813A			4		
QLY- ACSL246			2		
QLY- ACSL024Z			2		
QLY- AL1170			16		
QPL20x 100x2PET			8		
QPL20x 100x3PET			8		
QSE3x8_5	Seal- Dichtung- Joint d'isolation- Guarnizione- Burlate		3		
QG-2	Hole plug- Abdeckkappe- Cache-vis- Tappi in legno- Embellecedor		3		

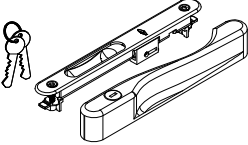
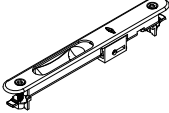

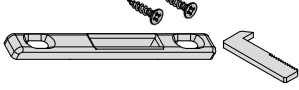
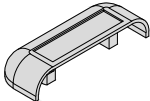
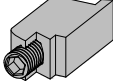
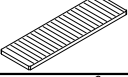
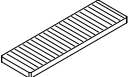
Pos	06.03.2024 SPECIFICATION-STÜCKLISTE-NOMENCLATURE-ELEMENTI-ESPECIFICACIÓN LU104-5P-7016	2/3	Pcs	Profile (mm)	Length (mm)
A-1			1	830x42	1855
B-1			1	830x42	1855
C-1			1	830x42	1855
SL8311 S-1			1	104x50	2719
SL8311 S-2	QLY-VG53/AN 2 		1	104x50	2719
SL8311 S-3			2	104x50	2050
QLY-SL076S-2			1		2050



Pos	06.03.2024 SPECIFICATION-STÜCKLISTE-NOMENCLATURE-ELEMENTI-ESPECIFICACIÓN LU104-5P-7016	3/3	Pcs	Profile (mm)	Length (mm)
QLY- ACSL243			1		
QLY- ACSL240			1		
QLY- ACSL815			4		
QLY- ACSL246			2		
QLY- ACSL024Z			3		
QLY- ALI170			16		
QPL20x 100x2PET			8		
QPL20x 100x3PET			8		
QSE3x8_5	Seal- Dichtung- Joint d'isolation- Guarnizione- Burtete		8		
QG-2	Hole plug- Abdeckkappe- Cache-vis- Tappi in legno- Embellecedor		8		
 	Object name PM70-9144			Page	13/13

H = 1.500 m  
TOTAL: 31.97 m<sup>2</sup>

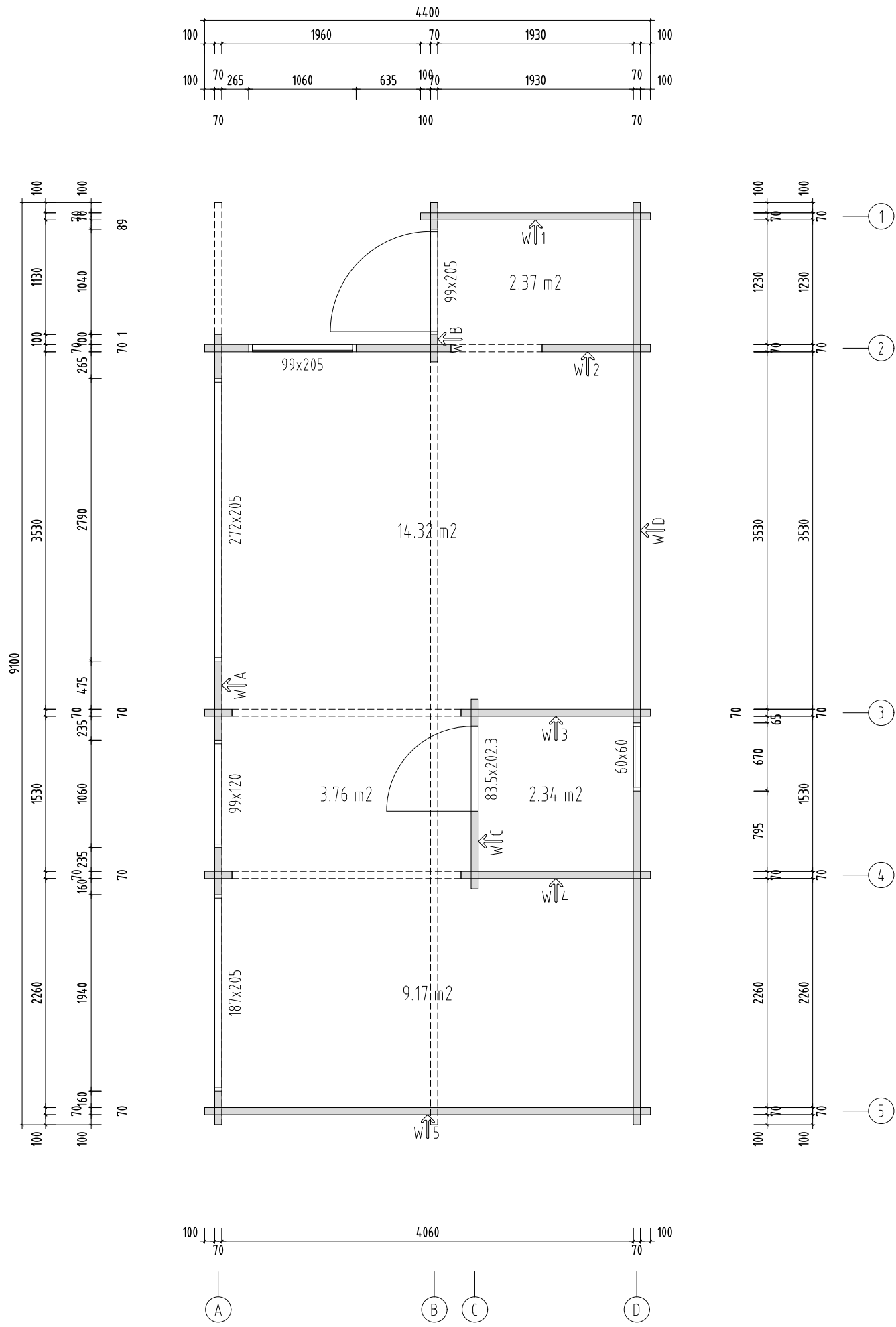

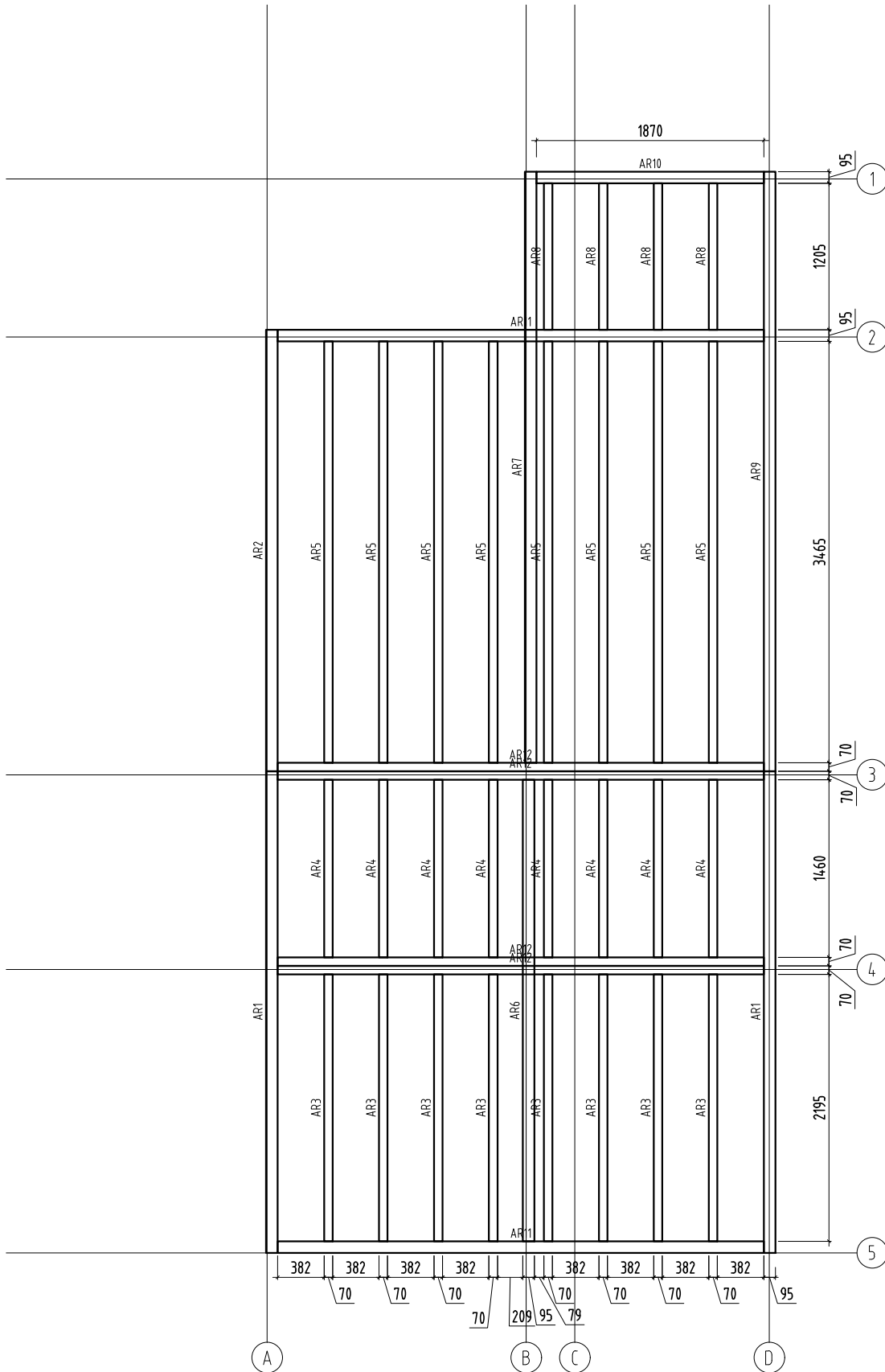







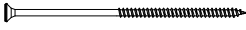
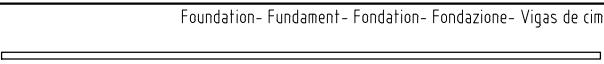
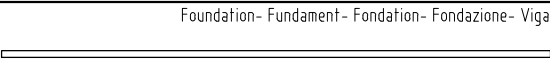
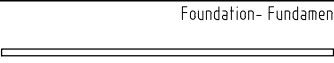

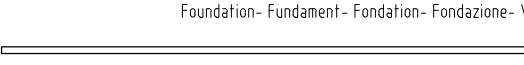
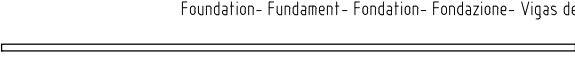
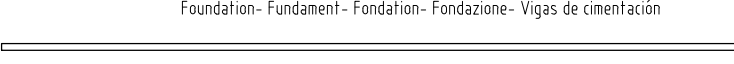
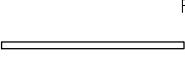
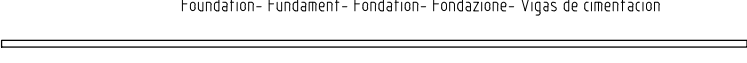
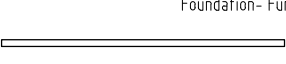
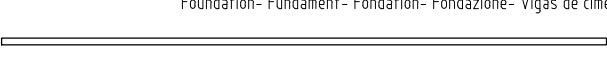
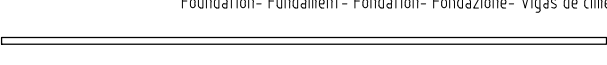
Plan 1 : Foundation plan - SPECIFICATION

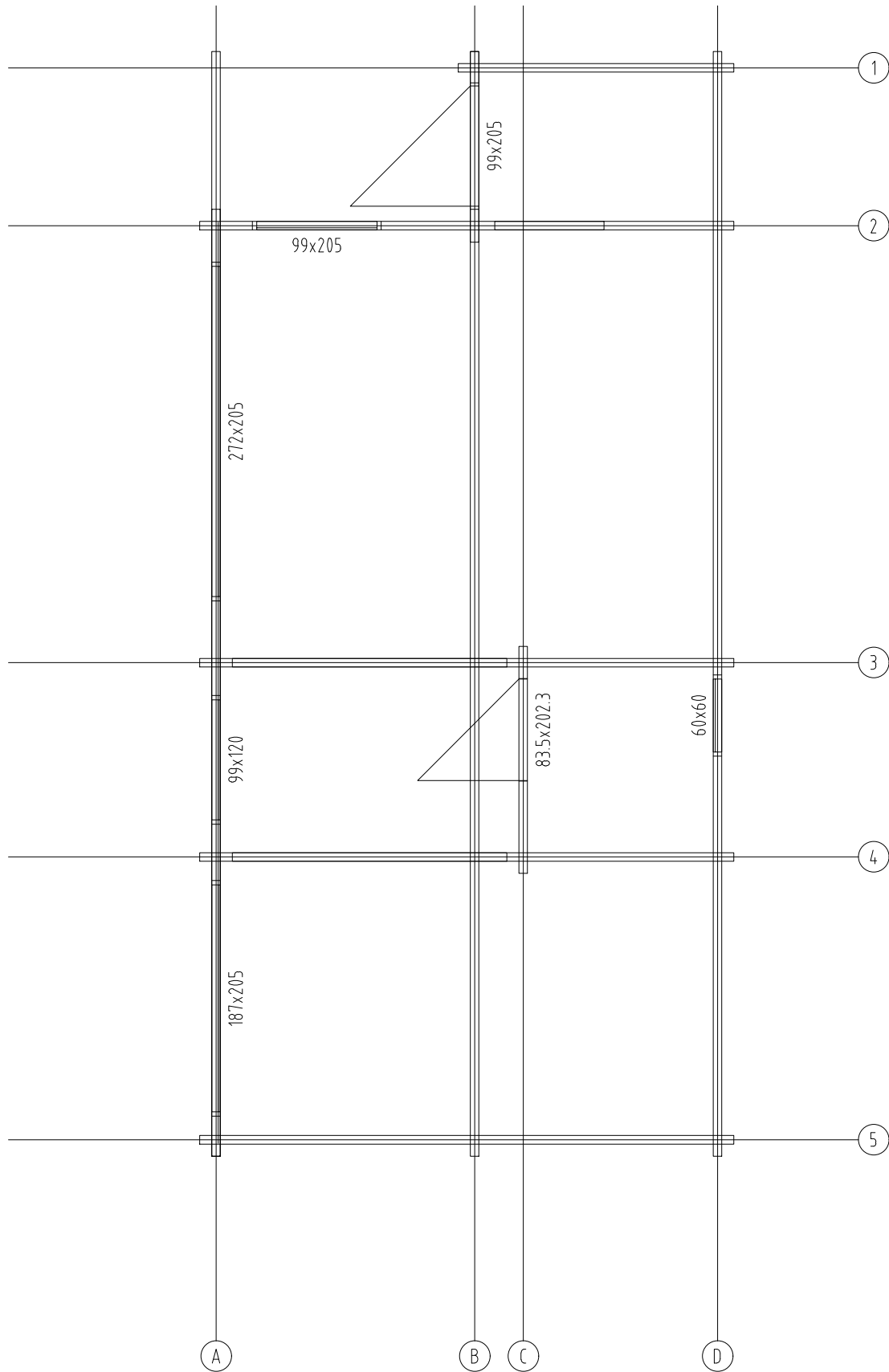
Check instructions guide !

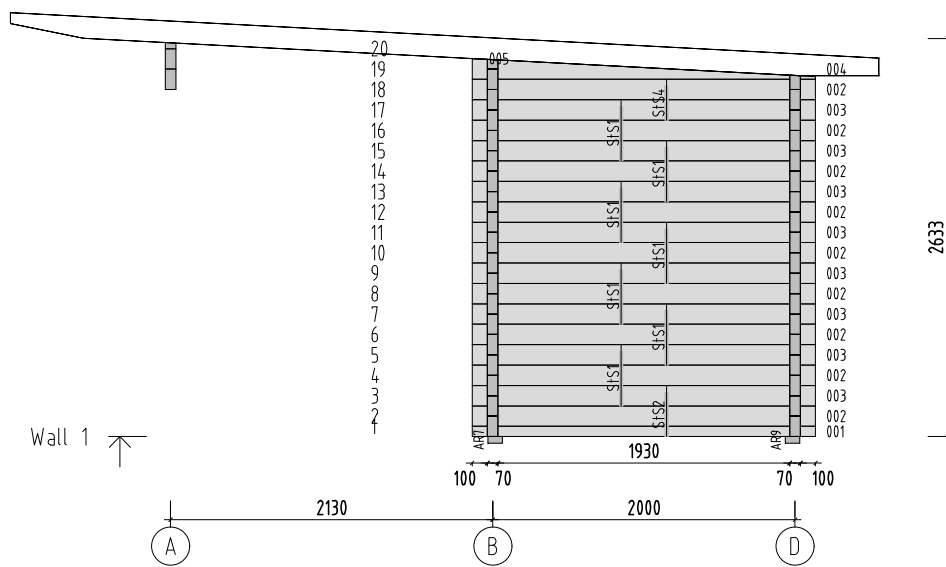

QKRPP 6x160 ZnTX-1	Screw- Schraube- Vis- Vite- Tornillo- 6x160mm TX-1		90	AR1, AR2,...	
AR1		Foundation- Fundament- Fondazione- Vigas de cimentación	2	95x45	3960
AR2		Foundation- Fundament- Fondazione- Vigas de cimentación	1	95x45	3630
AR3		Foundation- Fundament- Fondazione- Vigas de cimentación	8	70x45	2195
AR4		Foundation- Fundament- Fondazione- Vigas de cimentación	8	70x45	1460
AR5		Foundation- Fundament- Fondazione- Vigas de cimentación	8	70x45	3465
AR6		Foundation- Fundament- Fondazione- Vigas de cimentación	1	95x45	3795
AR7		Foundation- Fundament- Fondazione- Vigas de cimentación	1	95x45	4860
AR8		Foundation- Fundament- Fondazione- Vigas de cimentación	4	70x45	1205
AR9		Foundation- Fundament- Fondazione- Vigas de cimentación	1	95x45	4930
AR10		Foundation- Fundament- Fondazione- Vigas de cimentación	1	95x45	1870
AR11		Foundation- Fundament- Fondazione- Vigas de cimentación	2	95x45	4000
AR12		Foundation- Fundament- Fondazione- Vigas de cimentación	4	70x45	4000





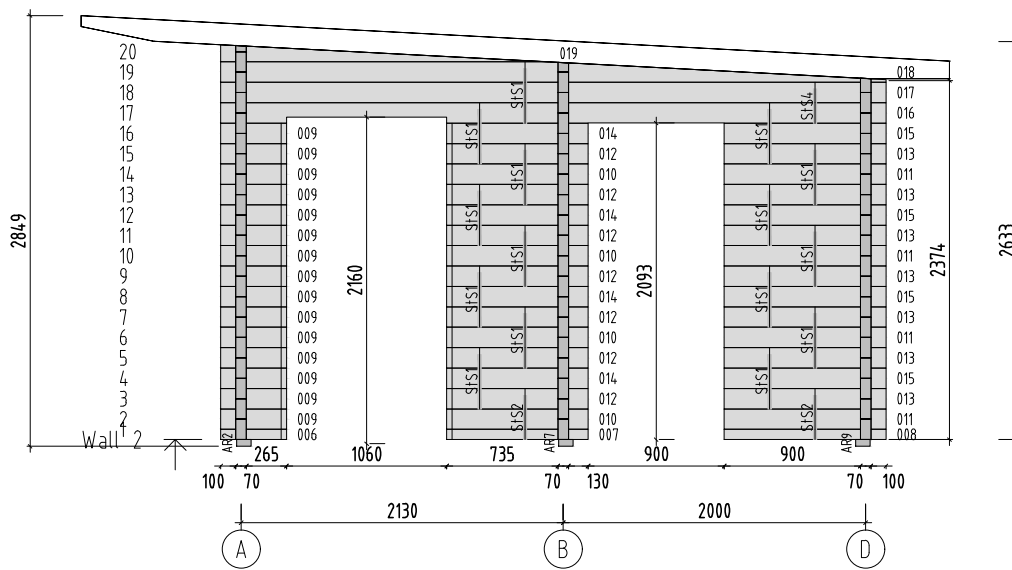



StS1	Stabilizing stick- Stabilisierungsstock- Baton équilibrant- Bastone stabilizzatore- Palo estabilizador		7	16x16	360
StS2	Stabilizing stick- Stabilisierungsstock- Baton équilibrant- Bastone stabilizzatore- Palo estabilizador		1	16x16	290
StS4	Stabilizing stick- Stabilisierungsstock- Baton équilibrant- Bastone stabilizzatore- Palo estabilizador		1	16x16	225

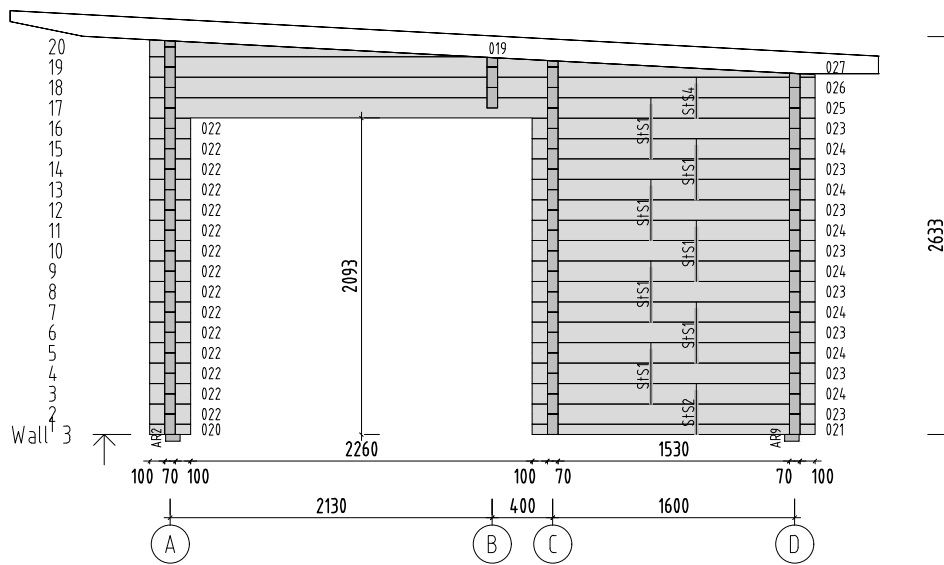



StS1	Stabilizing stick- Stabilisierungsstock- Baton équilibrant- Bastone stabilizzatore- Palo estabilizador		15	16x16	360
StS2	Stabilizing stick- Stabilisierungsstock- Baton équilibrant- Bastone stabilizzatore- Palo estabilizador		2	16x16	290
StS4	Stabilizing stick- Stabilisierungsstock- Baton équilibrant- Bastone stabilizzatore- Palo estabilizador		1	16x16	225



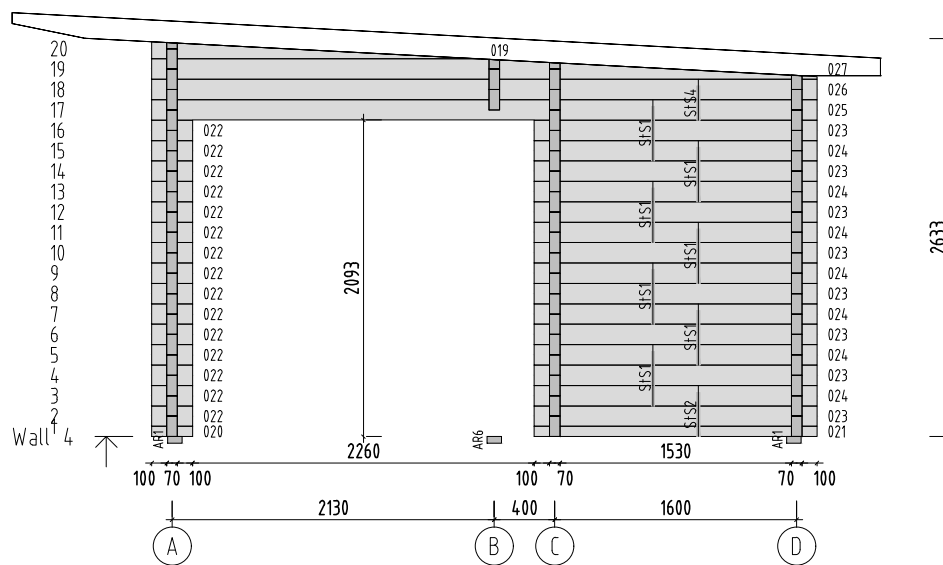

StS1	Stabilizing stick- Stabilisierungsstock- Baton équilibrant- Bastone stabilizzatore- Palo estabilizador		7	16x16	360
StS2	Stabilizing stick- Stabilisierungsstock- Baton équilibrant- Bastone stabilizzatore- Palo estabilizador		1	16x16	290
StS4	Stabilizing stick- Stabilisierungsstock- Baton équilibrant- Bastone stabilizzatore- Palo estabilizador		1	16x16	225



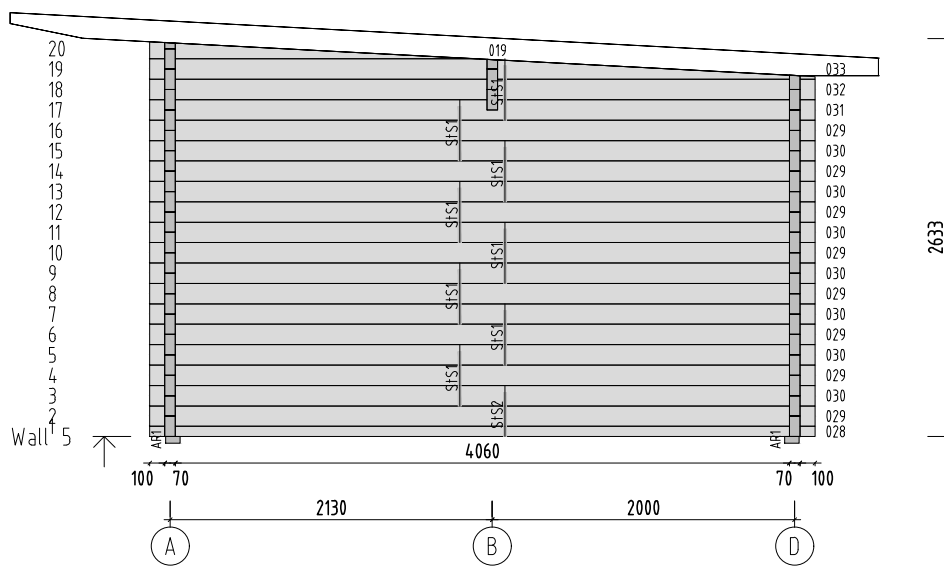







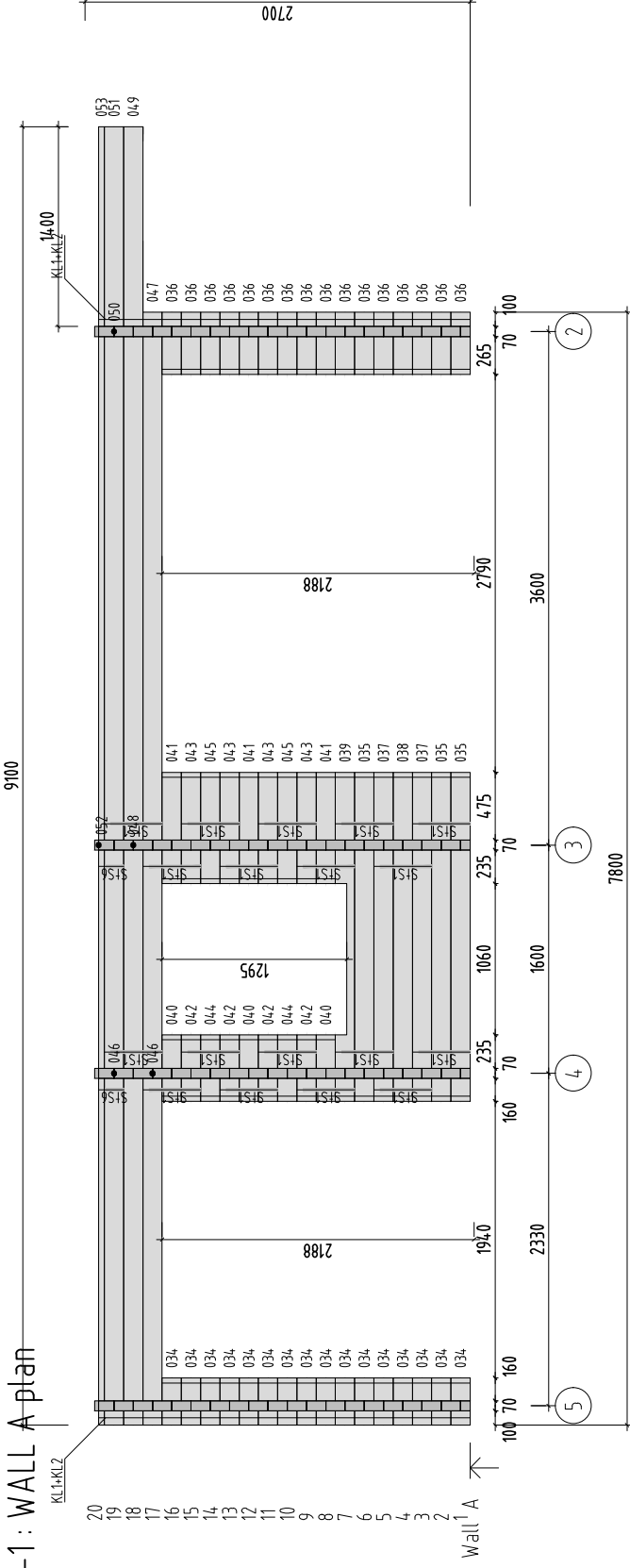



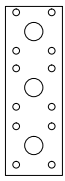



StS1	Stabilizing stick- Stabilisierungsstock- Baton équilibrant- Bastone stabilizzatore- Palo estabilizador		7	16x16	360
StS2	Stabilizing stick- Stabilisierungsstock- Baton équilibrant- Bastone stabilizzatore- Palo estabilizador		1	16x16	290
StS4	Stabilizing stick- Stabilisierungsstock- Baton équilibrant- Bastone stabilizzatore- Palo estabilizador		1	16x16	225



StS1	Stabilizing stick- Stabilisierungsstock- Baton équilibrant- Bastone stabilizzatore- Palo estabilizador		8	16x16	360
StS2	Stabilizing stick- Stabilisierungsstock- Baton équilibrant- Bastone stabilizzatore- Palo estabilizador		1	16x16	290

# Plan 8-1: WALL A plan



QNA4 x40Zn	Nail - Nagel - Clou - Chiodo - Clavo - 4x40mm - EM72801		40	
QLI2 5x10	Connection tape - Verbindungsband für Bohlen - Ruban de connection - Nastro di connessione - Cinta de conexión 1x25x60 mm		5	
KL1	Threaded rod - Gewindestangen - Barre filettata - Asta filettata - Varilla roscada M10		2	2000
KL2	Threaded rod - Gewindestangen - Barre filettata - Asta filettata - Varilla roscada M10		2	656
QMUK K10ZN	Nut - Schraubenmutter - Écrou - Dado - Tuerca - M10mm		2	
QSE10 X30ZN	Washer - Dichtscheibe - Joint - Rondella - Arandela - 10x30mm		2	
QMUJ 10ZN	Extension nut - Verlängerungsmutter - Ecrou rallonge - Dado di prolunga - Tuerca de extension - JM10		2	
QMUP L10ZN	Top nut - Schweissmutter mit Flansch - Ecrou a souder - Dado a saldare - Tuerca soldable - M10		2	
StS1	Stabilizing stick - Stabilisierungsstock - Baton équilibrant - Bastone stabilizzatore - Palo estabilizador		18	16x16 360
StS6	Stabilizing stick - Stabilisierungsstock - Baton équilibrant - Bastone stabilizzatore - Palo estabilizador		2	16x16 210









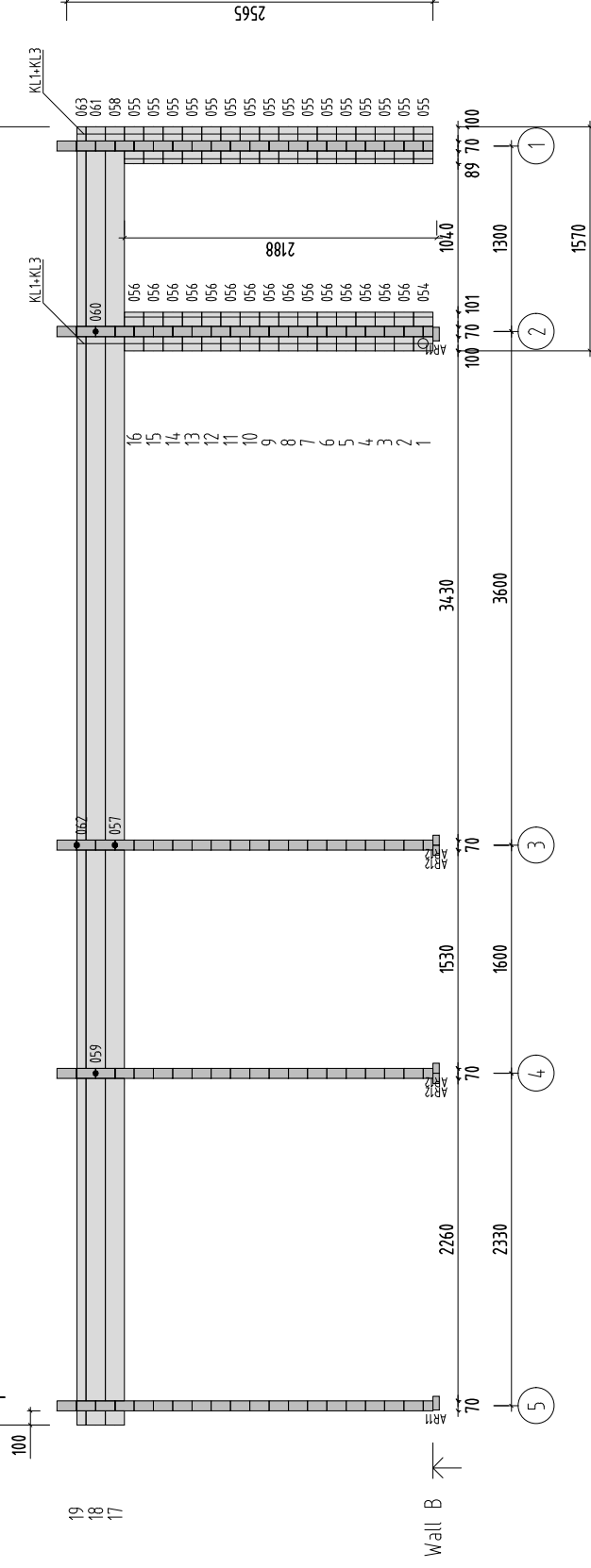



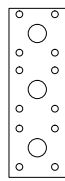

Check instructions guide!



# Plan 8-2 : WALL B plan

9100

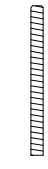









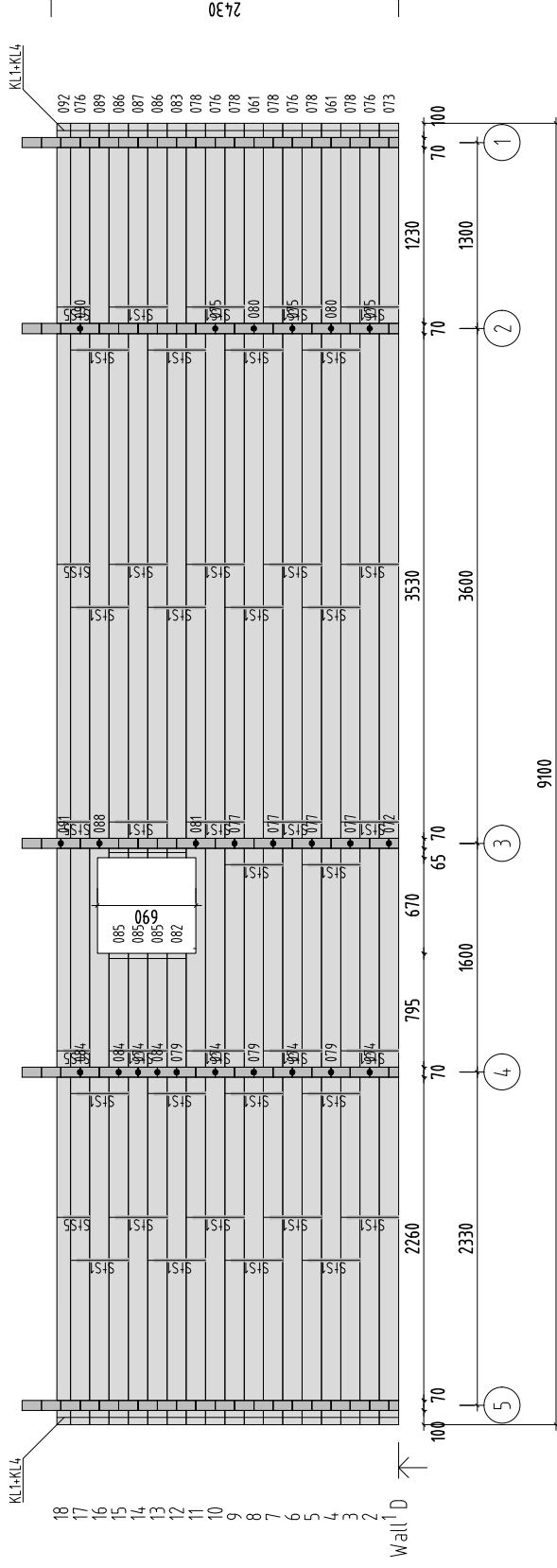



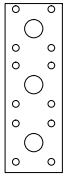
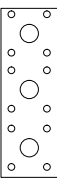
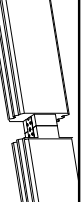



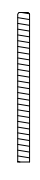

QNA4 x40Zn	Nail- Nagel- Clou- Chiodo- 4x4.0mm- EM72801		32	
QL12 5x1_0	Connection tape - Verbindungsband für Bohlen - Ruban de connection - Nastro di connessione- Cinta de conexion 1x25x60 mm		4	
KL1	Threaded rod- Gewindestangen- Barre filettée- Asta filettata- Varilla roscada M10		2	2000
KL3	Threaded rod- Gewindestangen- Barre filettée- Asta filettata- Varilla roscada M10		2	544
QMUK K10ZN	Nut- Schraubenmutter- Écrou- Dado- Tuerca- M10mm		2	
QSE10 X30ZN	Washer- Dichtscheibe- Joint- Rondella- Arandela- 10x30mm		2	
QMUJ 10ZN	Extension nut- Verlängerungsmutter- Écrou rallonge- Dado di prolunga- Tuerca de extensión- JM10		2	
QMUP L10ZN	Top nut- Schweissmutter mit Flansch- Errou a souder- Dado a saldare- Tuerca soldable- M10		2	
QKA85	Covering cap - Abdeckkappe - Couvertcle - Copertura- Cubierta		1	054

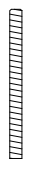
Check instructions guide !

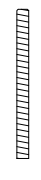

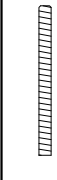
Plan 8-4: WALL D plan

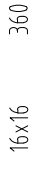



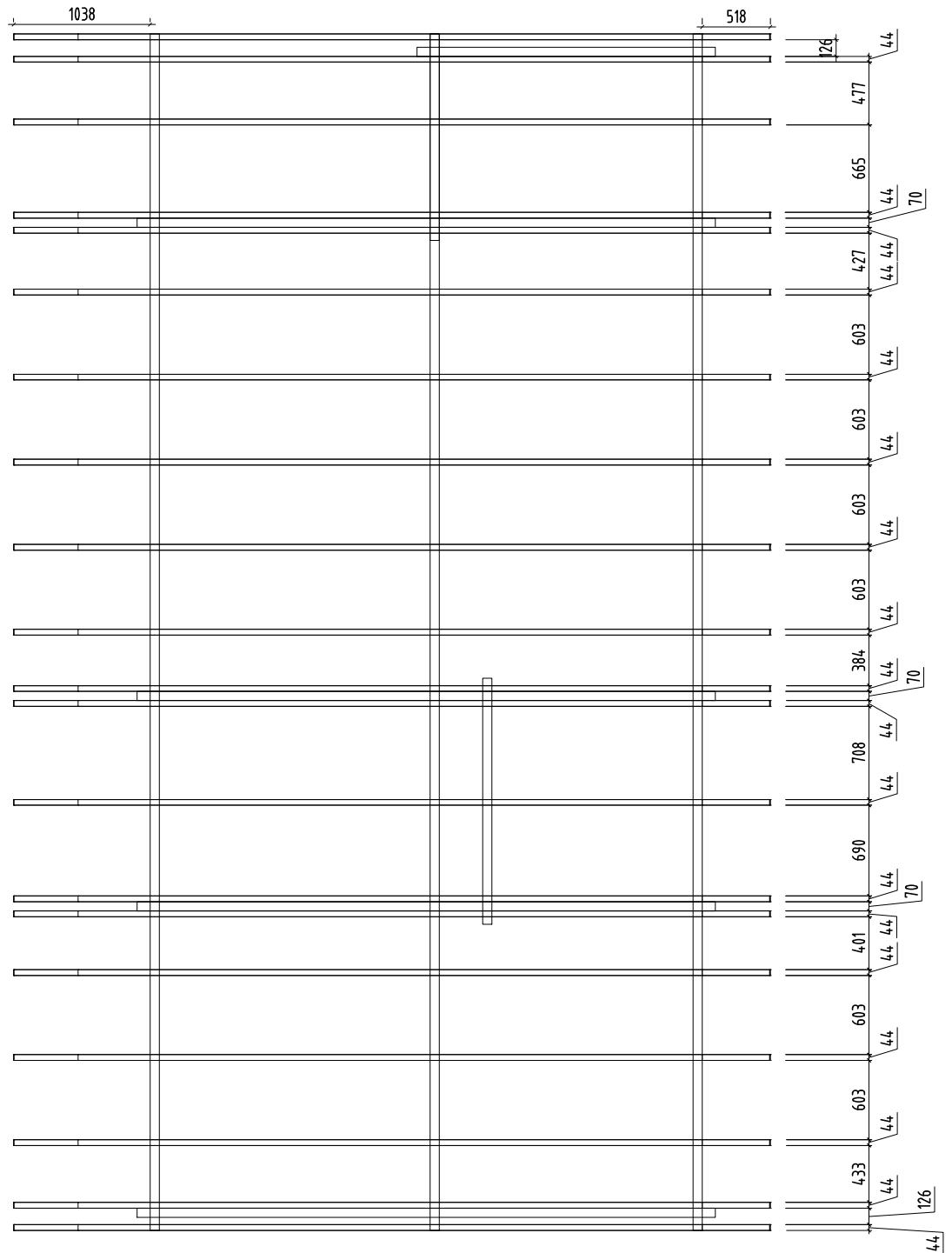

QNA4 x40Zn	Nail- Nagel- Clou- Clavo- 4x4.0mm- EMT2801		192		2000
QL12 5x1_0	Connection tape - Verbindungsband für Bohlen - Ruban de connection - Nastro di connessione - Cinta de conexio 1x25x60 mm		24		440
KL1	Threaded rod- Gewindestangen- Barre fileté- Asta filettata- Varilla roscada M10		2		2000
KL4	Threaded rod- Gewindestangen- Barre fileté- Asta filettata- Varilla roscada M10		2		440
QMUK K10ZN	Nut- Schraubenmutter- Écrou- Dado- Tuerca- M10mm		2		
QSE10 X30ZN	Washer- Dichtscheibe- Joint- Rondella- Arandela- 10x30mm		2		
QMUJ 10ZN	Extension nut- Verlängerungsmutter- Écrou rallonge- Dado di prolunga- Tuerca de extensión- JM10		2		
QMUP L10ZN	Top nut- Schweissmutter mit Flansch- Écrou a souder- Dado a saldare- Tuerca soldable- M10		2		
STS1	Stabilizing stick- Stabilisierungsstock- Baton équilibrant- Bastone stabilizzatore- Palo estabilizador		36		360
STS5	Stabilizing stick- Stabilisierungsstock- Baton équilibrant- Bastone stabilizzatore- Palo estabilizador		5		180

Check instructions guide !

# Plan 9: Rafter plan



Check instructions guide !

QKRYP8 x260Zn	Screw- Schraube- Vis- Vite- Tornillo- 8x260mm ZnY		60	
QKRPP4 5x70Zn	Screw- Schraube- Vis- Vite- Tornillo- 4.5x70mm		152	
	Rafter- Sparre- Chevron- Trave- Cabrio			
RoR1		20	140x44	5756
	Rafter- Sparre- Chevron- Trave- Cabrio			
RoR2		8	140x44	4500

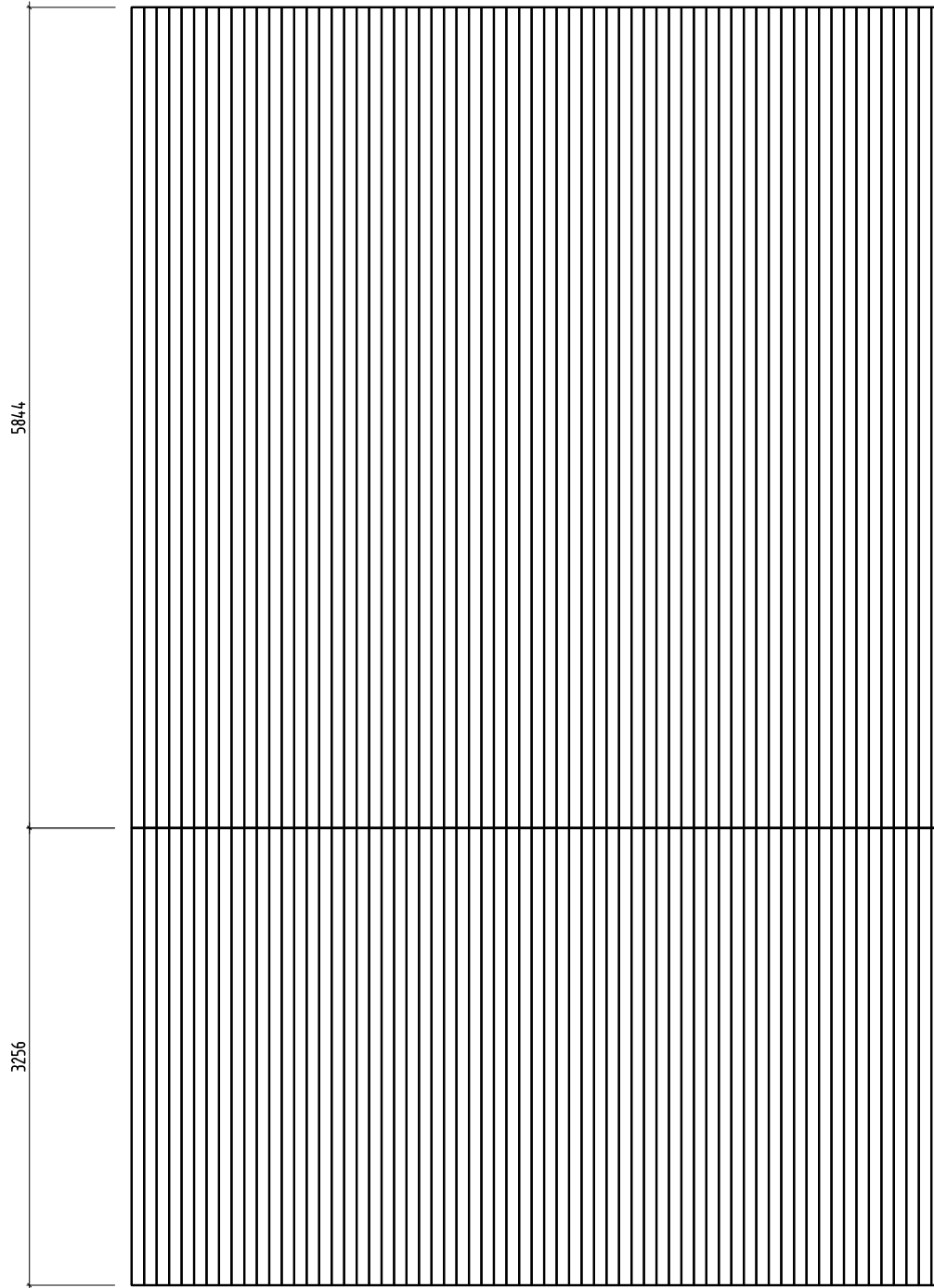

QNA2  
2x50Zn Nail - Nagel - Clou - Chiodo - Clavo - 2.5x50mm



1300

RB2-1  
RB2-2

RB2-2 Roof board - Dachbrett - Madrier du toit - Tavola tetto - Tabla de tejado



65+1

89x19

3256

RB2-1 Roof board - Dachbrett - Madrier du toit - Tavola tetto - Tabla de tejado



65+1

89x19

5844

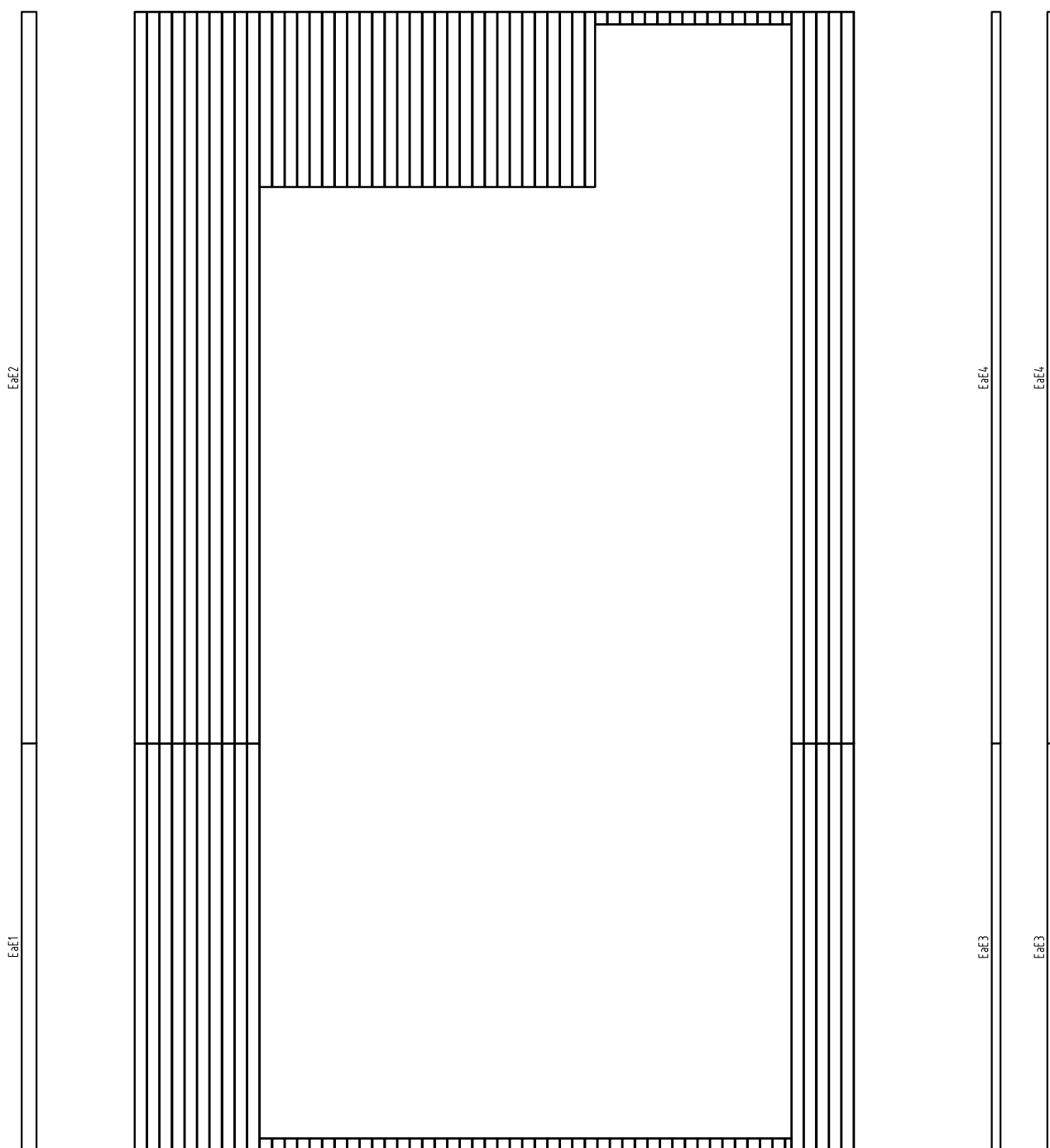
QKRPP3  
5x50Zn

Screw- Schraube- Vis- Vite- Tornillo- 3.5x50mm



500

TB3-1	Ceiling board- Dachbodenbrett- Madrier du Grenier- Tavola soffitta- Tabla de techo		15+2	95x16	5844
TB3-2	Ceiling board- Dachbodenbrett- Madrier du Grenier- Tavola soffitta- Tabla de techo		15+2	95x16	3256
TB3-3	Ceiling board- Dachbodenbrett- Madrier du Grenier- Tavola soffitta- Tabla de techo		27+1	95x16	1400
TB3-4	Ceiling board- Dachbodenbrett- Madrier du Grenier- Tavola soffitta- Tabla de techo		59+2	95x16	100
EaE1	Eave edging- Dachrandbrett- Madrier en bordure du toit- Tavola bordo tetto- Tabla de valadizo		1	120x28	3256
EaE2	Eave edging- Dachrandbrett- Madrier en bordure du toit- Tavola bordo tetto- Tabla de valadizo		1	120x28	5844
EaE3	Eave edging- Dachrandbrett- Madrier en bordure du toit- Tavola bordo tetto- Tabla de valadizo		2	70x28	3256
EaE4	Eave edging- Dachrandbrett- Madrier en bordure du toit- Tavola bordo tetto- Tabla de valadizo		2	70x28	5844

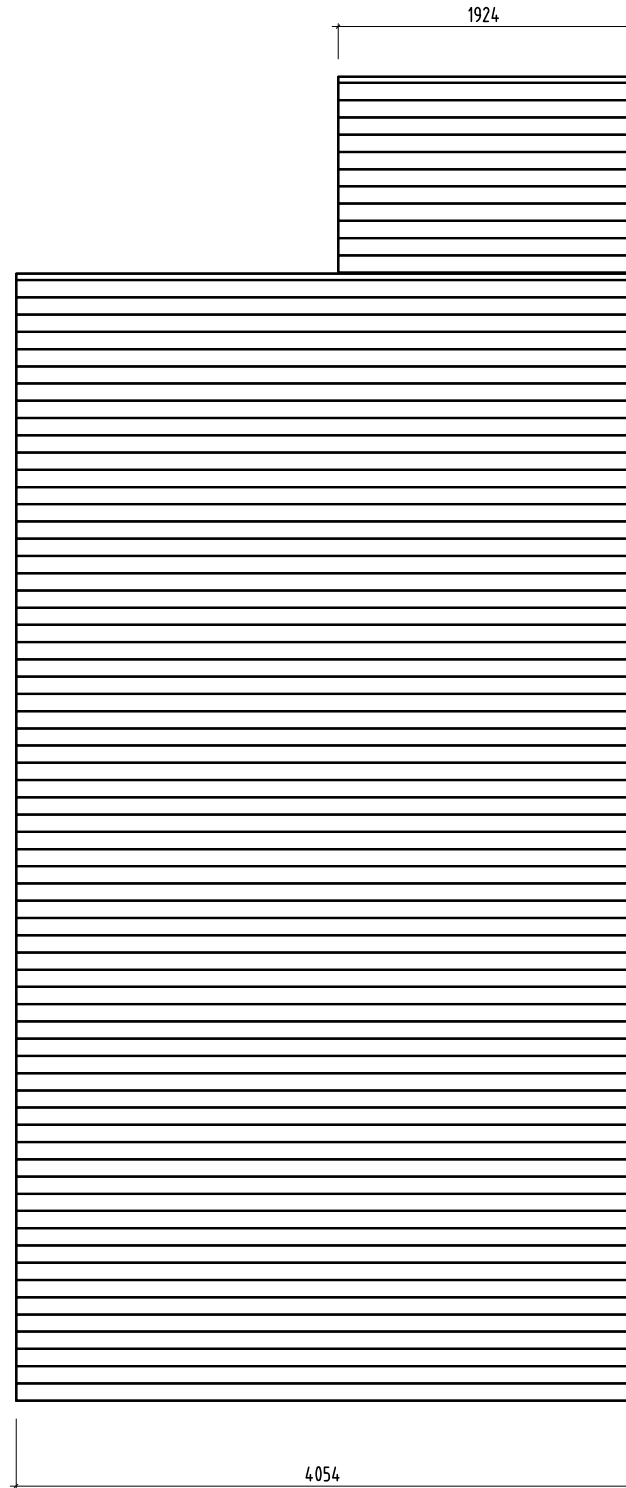

2FB3-1	Floor board- Fussbodenbrett- Madrier du plancher - Tavola pavimento- Tabla de suelo		66+1	114x28	4054
2FB3-2	Floor board- Fussbodenbrett- Madrier du plancher - Tavola pavimento- Tabla de suelo		12+1	114x28	1924
F1B3-1	Floor beading- Fussbodenleiste- Baguette du plancher- Listello pavimento- Listón de suelo		20	19x45	1600
QNA3 x70Zn	Nail- Nagel- Clou- Chiodo- Clavo- 3x70mm		800	2FB3-1 2FB3-2	

# Plan 13-A : Window - Fenster - Fenetre - Finestra-Ventana 600x600



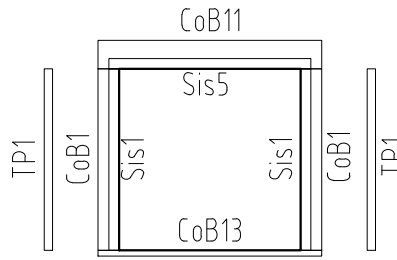



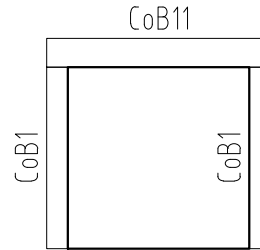





COB INTERNAL

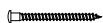

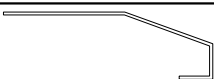
COB EXTERNAL

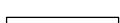

Check instructions guide !

QLY-A CVG45Z	Window fittings- Fenstergriff- Poigne de la fenetre- Maniglia finestra- Manilla- QLY-ACVG45Z		1		
QLY-A CMAS29	Window fittings- Fenstergriff- Poigne de la fenetre- Maniglia finestra- Manilla- QLY-ACMAS29		1		
QLY-A CMAS33	Window fittings- Fenstergriff- Poigne de la fenetre- Maniglia finestra- Manilla- QLY-ACMAS33		1		
QKRPP3 _5x50Zn	Screw- Schraube- Vis- Vite- Tornillo- 3.5x50mm		22		
QKRYP 5x60Zn	Screw- Schraube- Vis- Vite- Tornillo- 5x60mm ZnY		4	U51-5 A51-13	
A51-13 P-7016	Window - Fenster - Fenetre - Finestra-Ventana 600x600	  500x500mm	1		
QP40x3 0x740MU	Water gutter- Wasserleiste- Rejet d'eau- Protección de lluvia- Protezione dalla pioggia- QP40x30x740		1	A51-13	
QTI40-1	Seal- Dichtung- Joint d'isolation- Guarnizione- Burlete- QTI40				
TP1	Tender post- Tenderleiste- T-poste- Rinforzo- Refuerzo		2	28x28	600
Sis1	Side slat- Randleiste- Baguette en bordure- Listón de borde- Listello bordo		2	34x70	600
Sis5	Side slat- Randleiste- Baguette en bordure- Listón de borde- Listello bordo		1	34x70	668
CoB1	Covering board- Deckbrett- Madrier de couverture- Tavola di copertura- Listón de cubierta		4	70x16	600
CoB11	Covering board- Deckbrett- Madrier de couverture- Tavola di copertura- Listón de cubierta		2	95x16	740
CoB13	Covering board- Deckbrett- Madrier de couverture- Tavola di copertura- Listón de cubierta		1	19x95	740



# Plan 13 - B : Window - Fenster - Fenetre - Finestra-Ventana 990X1200

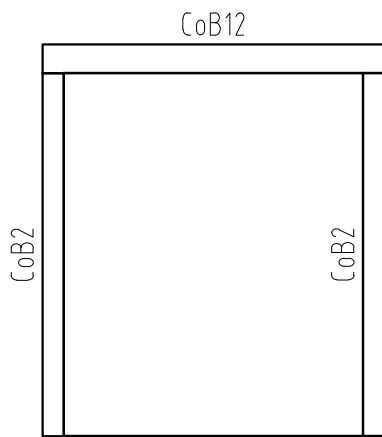



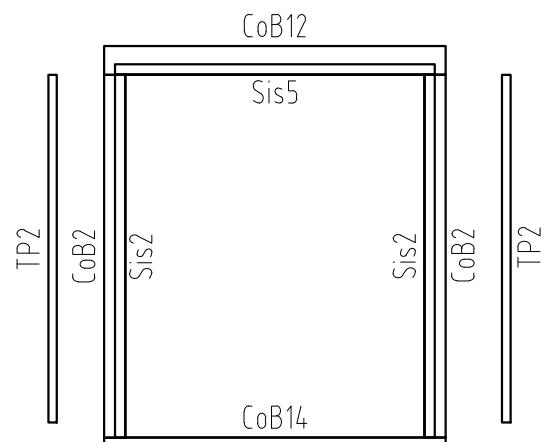







COB EXTERNAL

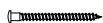
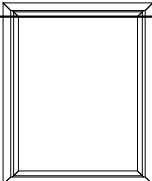
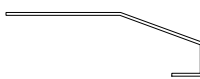

COB INTERNAL

Check instructions guide !

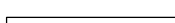



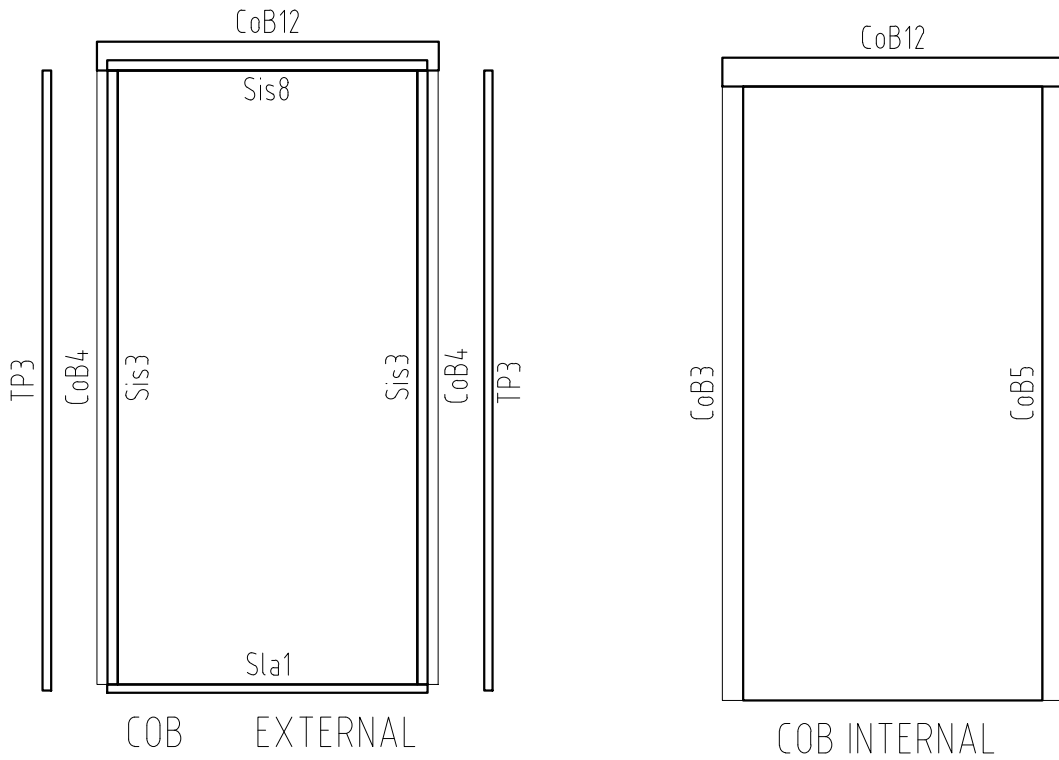







QLY-A CVG45Z	Window fittings- Fenstergriff- Poigne de la fenetre- Maniglia finestra- Manilla- QLY-ACVG45Z		1	
QLY-A CMAS29	Window fittings- Fenstergriff- Poigne de la fenetre- Maniglia finestra- Manilla- QLY-ACMAS29		1	
QLY-A CMAS33	Window fittings- Fenstergriff- Poigne de la fenetre- Maniglia finestra- Manilla- QLY-ACMAS33		1	
QKRPP3 _5x50Zn	Screw- Schraube- Vis- Vite- Tornillo- 3.5x50mm		22	
QKRYP 5x60Zn	Screw- Schraube- Vis- Vite- Tornillo- 5x60mm ZnY		8	U51-5 A51-13
A51-14 P-7016	Window - Fenster - Fenetre - Finestra-Ventana 990x1200	 890x1100mm	1	
QP40x30 x1128MU	Water gutter- Wasserleiste- Rejet d'eau- Protección de lluvia- Protezione dalla pioggia- QP40x30x1128		1	A51-14 P-7016
QTI40-1	Seal- Dichtung- Joint d'isolation- Guarnizione- Burlate- QTI40			
TP2	Tender post- Tenderleiste- T-poste- Rinforzo- Refuerzo		4	28x28 1150
Sis2	Side slat- Randleiste- Baguette en bordure- Listón de borde- Listello bordo		4	34x70 1200
Sis5	Side slat- Randleiste- Baguette en bordure- Listón de borde- Listello bordo		2	34x70 1058
CoB2	Covering board- Deckbrett- Madrier de couverture- Tavola di copertura- Listón de cubierta		8	70x16 1200
CoB12	Covering board- Deckbrett- Madrier de couverture- Tavola di copertura- Listón de cubierta		4	95x16 1130
CoB14	Covering board- Deckbrett- Madrier de couverture- Tavola di copertura- Listón de cubierta		1	19x95 1130

# Plan 13 - C : Window - Fenster - Fenetre - Finestra-Ventana 990x2050



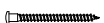

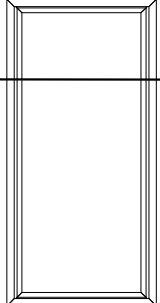





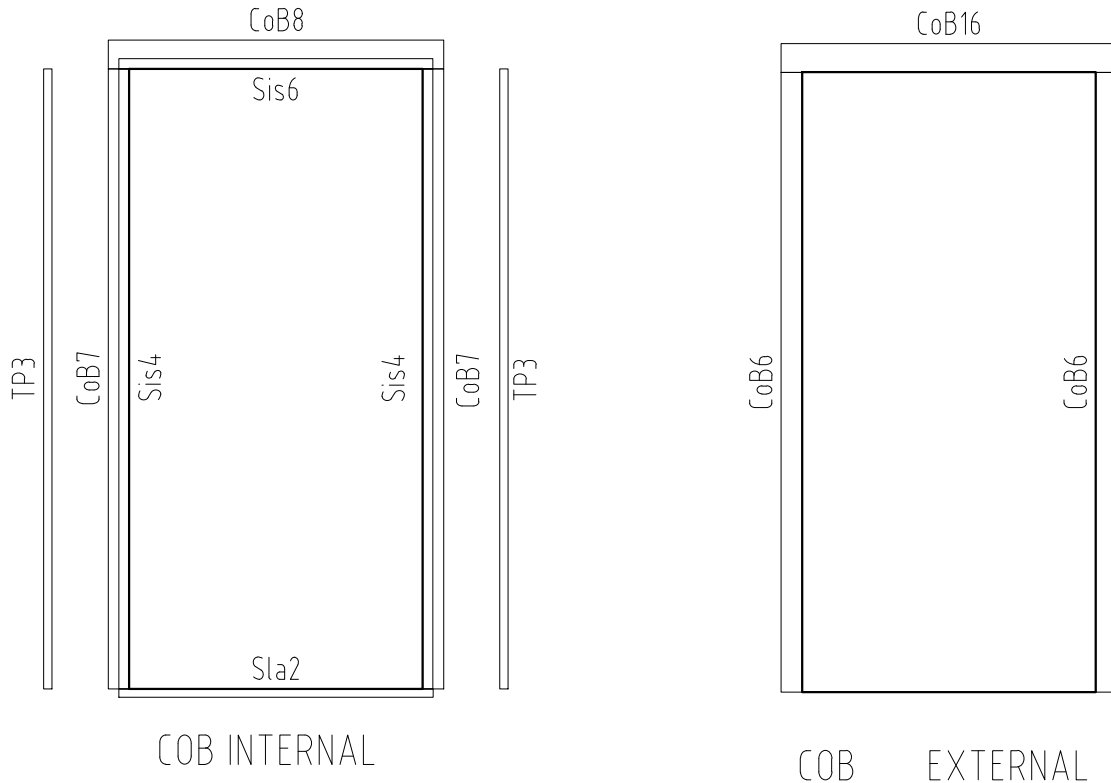

COB EXTERNAL

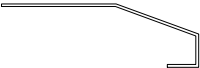
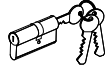
COB INTERNAL

CoB3	Covering board- Deckbrett- Madrier de couverture- Tavola di copertura- Listón de cubierta		1	70x28	2031
CoB4	Covering board- Deckbrett- Madrier de couverture- Tavola di copertura- Listón de cubierta		2	70x28	2030
CoB5	Covering board- Deckbrett- Madrier de couverture- Tavola di copertura- Listón de cubierta		1	70x28	2030
CoB12	Covering board- Deckbrett- Madrier de couverture- Tavola di copertura- Listón de cubierta		2	95x16	1130
Sis3	Side slat- Randleiste- Baguette en bordure- Listón de borde- Listello bordo		1	34x70	2030
Sis8	Side slat- Randleiste- Baguette en bordure- Listón de borde- Listello bordo		1	34x70	1058
TP3	Tender post- Tenderleiste- T-poste- Rinforzo- Refuerzo		2	28x28	2050
Sla1	Slat- Leiste- Baguette- Listello- Listón		1	28x70	1059
QKRPP3_5x50Zn	Screw- Schraube- Vis- Vite- Tornillo- 3.5x50mm		22		
QKRYP 5x60Zn	Screw- Schraube- Vis- Vite- Tornillo- 5x60mm ZnY		8	U51-5 A51-13	
QP40x30 x1128MU	Water gutter- Wasserleiste- Rejet d'eau- Protección de lluvia- Protezione dalla pioggia- QP40x30x1128		1	A51-14 P-7016	
QT140-1	Seal- Dichtung- Joint d'isolation- Guarnizione- Burlate- QT140				
A51-1 5-7016	Window - Fenster - Fenetre - Finestra-Ventana 990x2050		1		
QLY-A CVG45Z	Window fittings- Fenstergriff- Poigne de la fenetre- Maniglia finestra- Manilla- QLY-ACVG45Z		1		

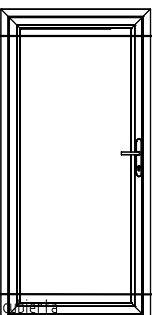
# Plan 14 : Door - Tür - Porte - Porta-Puerta 990x2050

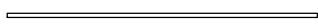
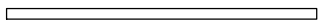
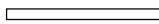

QTI40-1	Seal- Dichtung- Joint d'isolation- Guarnizione- Burlete- QTI40				
QP40x30 x1109MU	Water gutter- Wasserleiste- Rejet d'eau- Protección de lluvia- Protezione dalla pioggia- QP40x30x1109		1	U51-5	
QLY- LWB02	Cylinder- Zylinderschloss- Serrure a mortaiser- Serratura a cilindro- Bombin- QLY-LWB02		1		
QLY-A CWKS92	Door fittings- Türbeschlag- Ferrure- Ferramenta porta- Manilla (puerta)- QLY-ACWKS92		1		
QKRPP3 5x50Zn	Screw- Schraube- Vis- Vite- Tornillo- 3.5x50mm		28		
QKRYP 5x60Zn	Screw- Schraube- Vis- Vite- Tornillo- 5x60mm ZnY		8	U51-5 A51-13	
U51-5 P-7016	Door - Tür - Porte - Porta-Puerta 990x2050		1		
CoB6	Covering board- Deckbrett- Madrier de couverture- Tavola di copertura- Listón de cubierta 874x1986mm		2	70x16	2049
CoB7	Covering board- Deckbrett- Madrier de couverture- Tavola di copertura- Listón de cubierta		2	70x28	2050
CoB8	Covering board- Deckbrett- Madrier de couverture- Tavola di copertura- Listón de cubierta		1	95x28	1109
CoB16	Covering board- Deckbrett- Madrier de couverture- Tavola di copertura- Listón de cubierta		1	95x16	1110
TP3	Tender post- Tenderleiste- T-poste- Rinforzo- Refuerzo		2	28x28	2050
Sis4	Side slat- Randleiste- Baguette en bordure- Listón de borde- Listello bordo		2	34x70	2050
Sla2	Slat- Leiste- Baguette- Listello- Listón		1	28x70	1039

# Plan 15 : MLU59-5P-7016

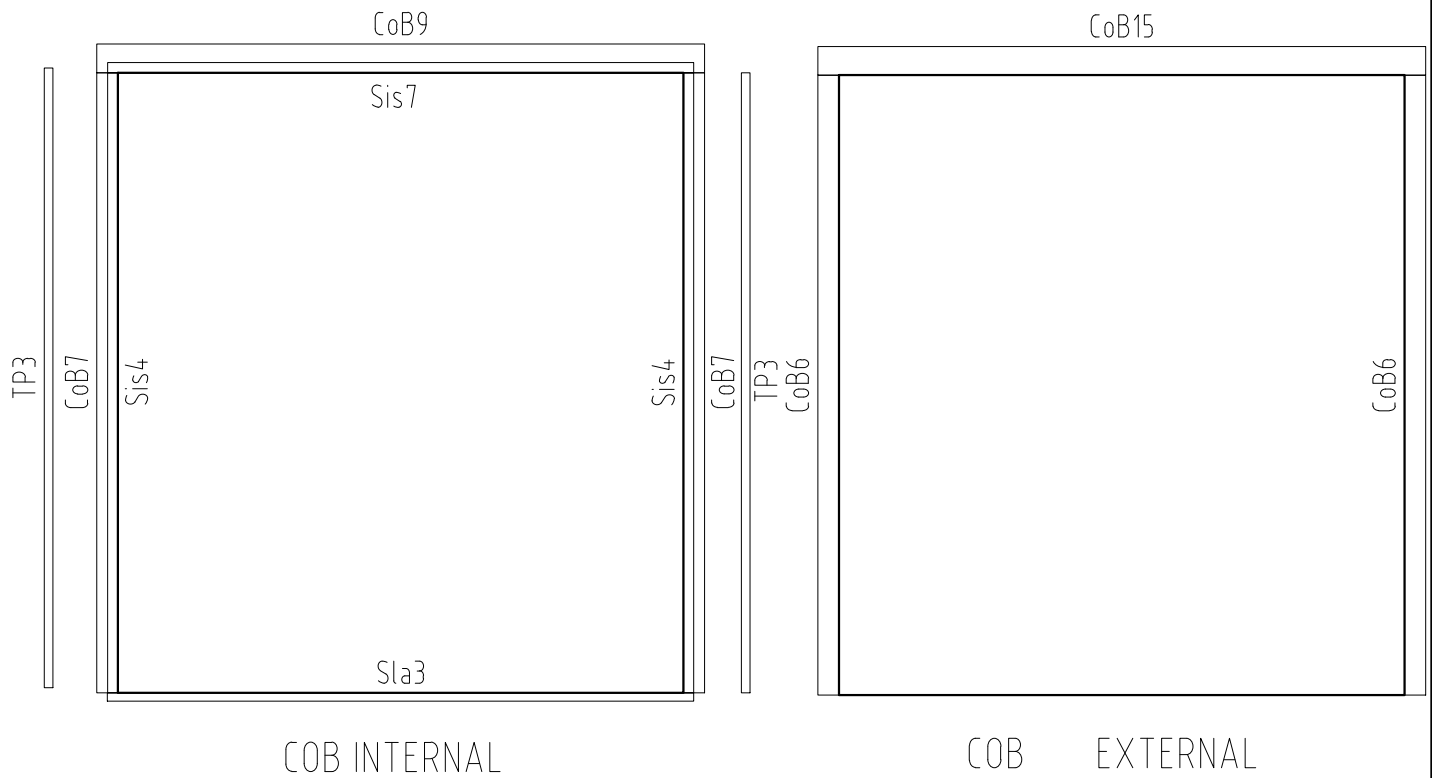

Check instructions guide !

QP40x30 x2010MU Water gutter- Wasserleiste- Rejet d'eau- Protección de lluvia- Protezione dalla pioggia- QP40x30x2010

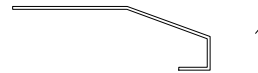

1

QTI40-1 Seal- Dichtung- Joint d'isolation- Guarnizione- Burlete- QTI40



QKRPP3\_5x50Zn Screw- Schraube- Vis- Vite- Tornillo- 3.5x50mm



28

QKRYP 5x60Zn Screw- Schraube- Vis- Vite- Tornillo- 5x60mm ZnY



10

U51-5  
A51-13

Covering board- Deckbrett- Madrier de couverture- Tavola di copertura- Listón de cubierta

CoB6



2

70x16

2049

Covering board- Deckbrett- Madrier de couverture- Tavola di copertura- Listón de cubierta

CoB7



2

70x28

2050

Covering board- Deckbrett- Madrier de couverture- Tavola di copertura- Listón de cubierta

CoB9



1

95x28

2010

Covering board- Deckbrett- Madrier de couverture- Tavola di copertura- Listón de cubierta

CoB15



1

95x16

2010

Tender post- Tenderleiste- T-poste- Rinforzo- Refuerzo

TP3



2

28x28

2050

Side slat- Randleiste- Baguette en bordure- Listón de borde- Listello bordo

Sis7



1

34x70

1938

Side slat- Randleiste- Baguette en bordure- Listón de borde- Listello bordo

Sis4

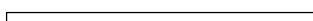

2

34x70

2050

Slat- Leiste- Baguette- Listello- Listón

Sla3



1

28x70

1939

Plan 15 : MLU59-5P-7016 x 2

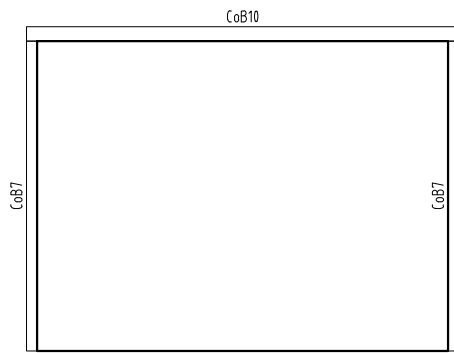

COB INTERNAL

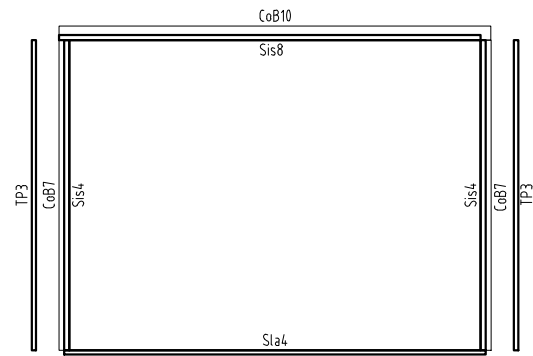

COB EXTERNAL

Check instructions guide !

QP40  
x30x  
2858MU

Water gutter- Wasserleiste- Rejet d'eau- Protección de lluvia- Protezione dalla pioggia- QP40x30x2858



1

QTI40-1

Seal- Dichtung- Joint d'isolation- Guarnizione- Burlete- QTI40



QKRPP3  
5x50Zn

Screw- Schraube- Vis- Vite- Tornillo- 3.5x50mm



28

QKRYP  
5x60Zn

Screw- Schraube- Vis- Vite- Tornillo- 5x60mm ZnY



10

U51-5  
A51-13

Covering board- Deckbrett- Madrier de couverture- Tavola di copertura- Listón de cubierta

CoB7



4

70x28

2050

Covering board- Deckbrett- Madrier de couverture- Tavola di copertura- Listón de cubierta

CoB10

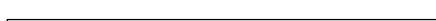

2

95x28

2857

Tender post- Tenderleiste- T-poste- Rinforzo- Refuerzo

TP3



2

28x28

2050

Side slat- Randleiste- Baguette en bordure- Listón de borde- Listello bordo

Sis4



2

34x70

2050

Side slat- Randleiste- Baguette en bordure- Listón de borde- Listello bordo

Sis8

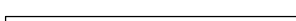

1

34x70

2788

Slat- Leiste- Baguette- Listello- Listón



Sla4



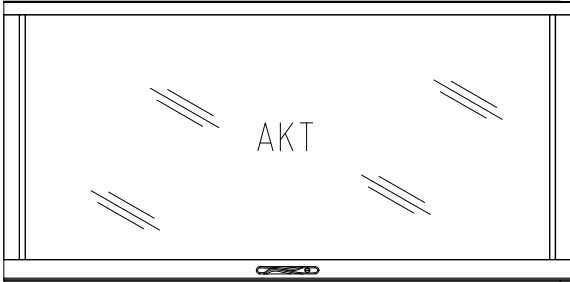
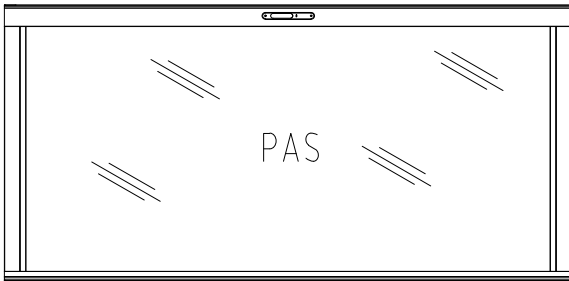
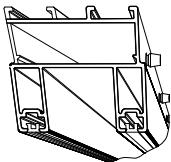
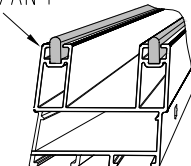
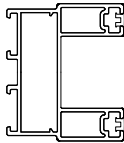

1

28x70

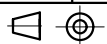

2787

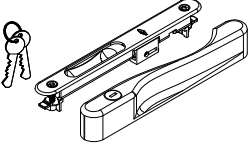
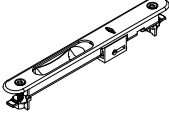
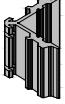
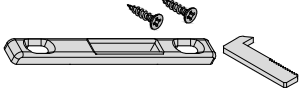
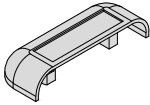
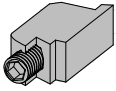
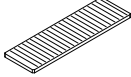
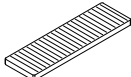
Pos	SPECIFICATION-STÜCKLISTE-NOMENCLATURE-ELEMENTI-ESPECIFICACIÓN LU59-5P-7016	4/5	Pcs	Profile (mm)	Length (mm)
A-2			1	916x42	1968
B-2			1	916x42	1968
SL8110 S-1			1	59x50	1870
SL8110 S-2	<p data-bbox="550 1214 715 1243">QLY-VG53/AN 1</p> 		1	59x50	1870
SL8110 S-3			2	59x50	2050
QLY-SL076S-1			1		1870



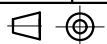

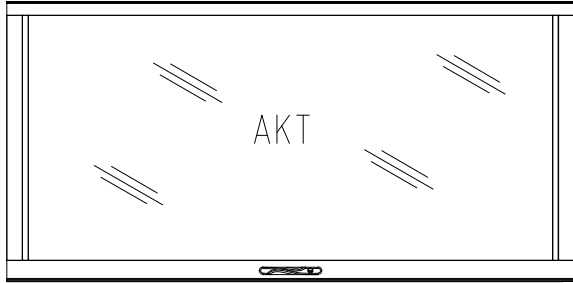
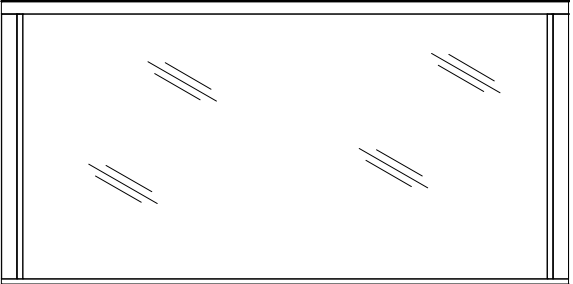
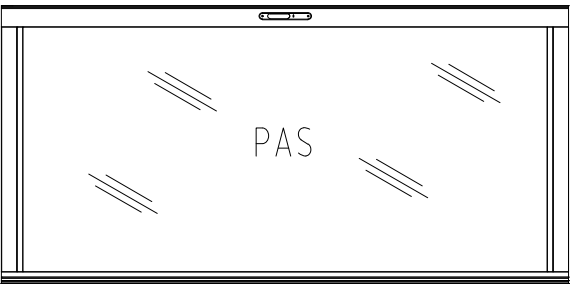
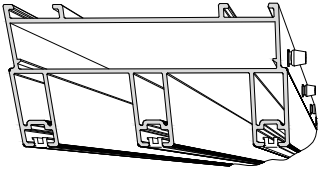
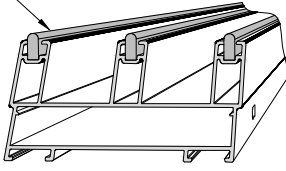
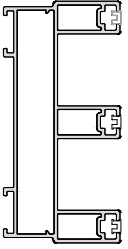

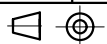

Pos	SPECIFICATION-STÜCKLISTE-NOMENCLATURE-ELEMENTI-ESPECIFICACIÓN LU59-5P-7016	5/5	Pcs	Profile (mm)	Length (mm)
QLY- ACSL243			1		
QLY- ACSL240			1		
QLY- ACSL813A			4		
QLY- ACSL246			2		
QLY- ACSL024Z			2		
QLY- AL1170			16		
QPL20x 100x2PET			8		
QPL20x 100x3PET			8		
QSE3x8_5	Seal- Dichtung- Joint d'isolation- Guarnizione- Burlate		3		
QG-2	Hole plug- Abdeckkappe- Cache-vis- Tappi in legno- Embellecedor		3		

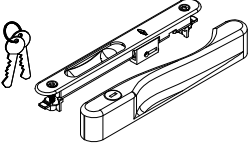
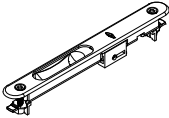

Pos	06.03.2024 SPECIFICATION-STÜCKLISTE-NOMENCLATURE-ELEMENTI-ESPECIFICACIÓN LU104-5P-7016	2/3	Pcs	Profile (mm)	Length (mm)
A-1			1	830x42	1855
B-1			1	830x42	1855
C-1			1	830x42	1855
SL8311 S-1			1	104x50	2719
SL8311 S-2	QLY-VG53/AN 2 		1	104x50	2719
SL8311 S-3			2	104x50	2050
QLY-SL076S-2			1		2050

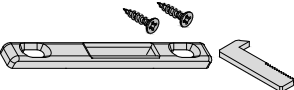
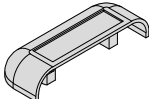
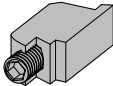
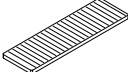
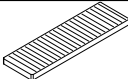



Pos	06.03.2024 SPECIFICATION-STÜCKLISTE-NOMENCLATURE-ELEMENTI-ESPECIFICACIÓN LU104-5P-7016	3/3	Pcs	Profile (mm)	Length (mm)
QLY- ACSL243			1		
QLY- ACSL240			1		
QLY- ACSL815			4		
QLY- ACSL246			2		
QLY- ACSL024Z			3		
QLY- ALI170			16		
QPL20x 100x2PET			8		
QPL20x 100x3PET			8		
QSE3x8_5	Seal- Dichtung- Joint d'isolation- Guarnizione- Burtete		8		
QG-2	Hole plug- Abdeckkappe- Cache-vis- Tappi in legno- Embellecedor		8		
 	Object name PM70-9144			Page	13/13

Plan 16 : Door - Tür - Porte - Porta-Puerta 835x2023

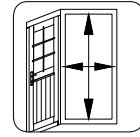
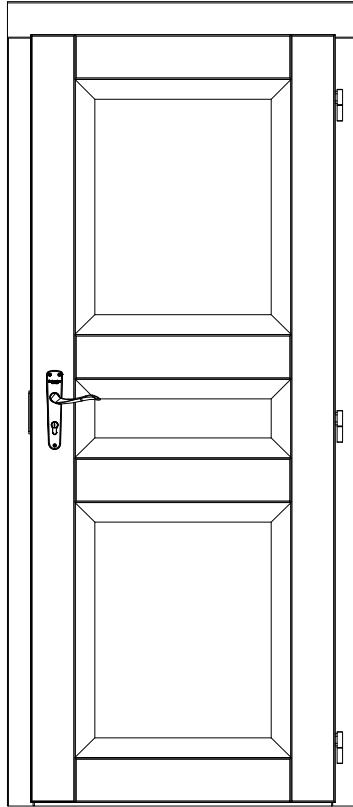

735x1954mm

Check instructions guide !

QVKA Door fittings- Türbeschlag- Ferrure- Ferramenta porta- Manilla (puerta)- QVKA  1

QLIUY-1 Door fittings- Türbeschlag- Ferrure- Ferramenta porta- Manilla (puerta)- QLIUY-1  1

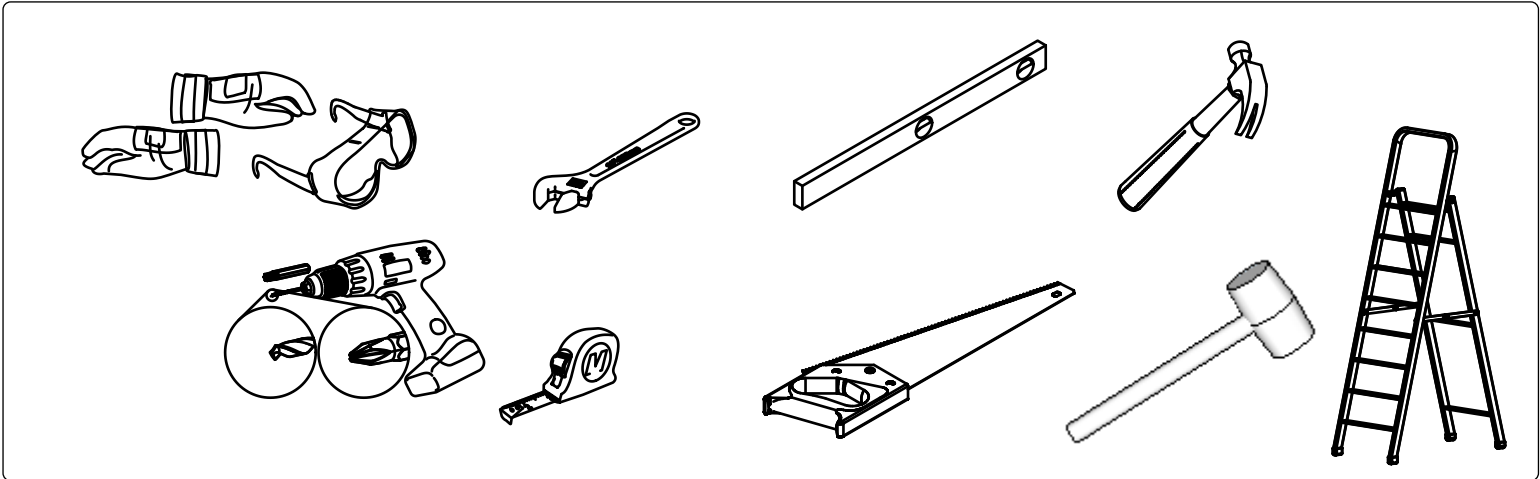
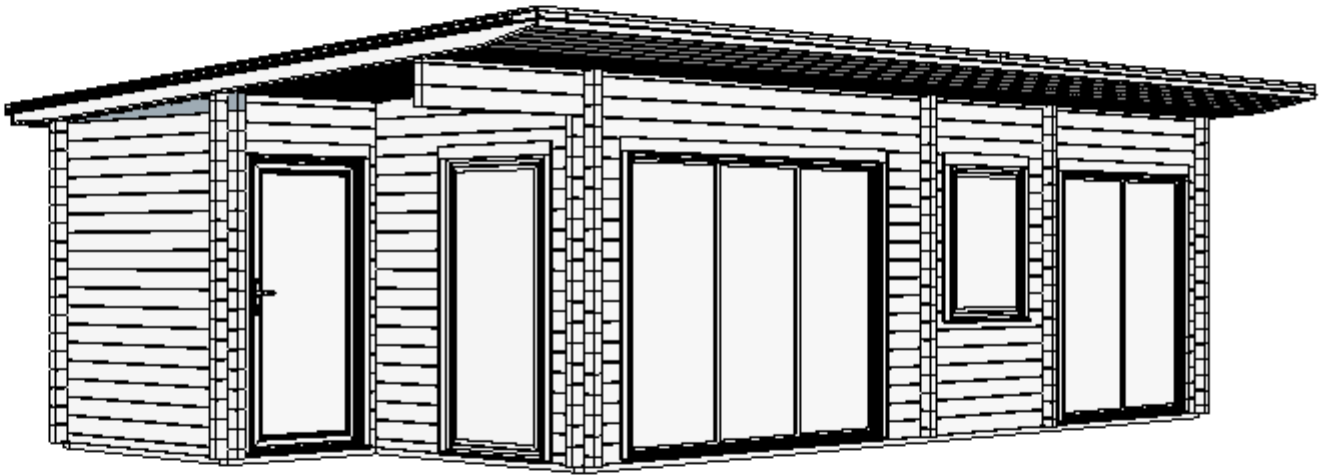

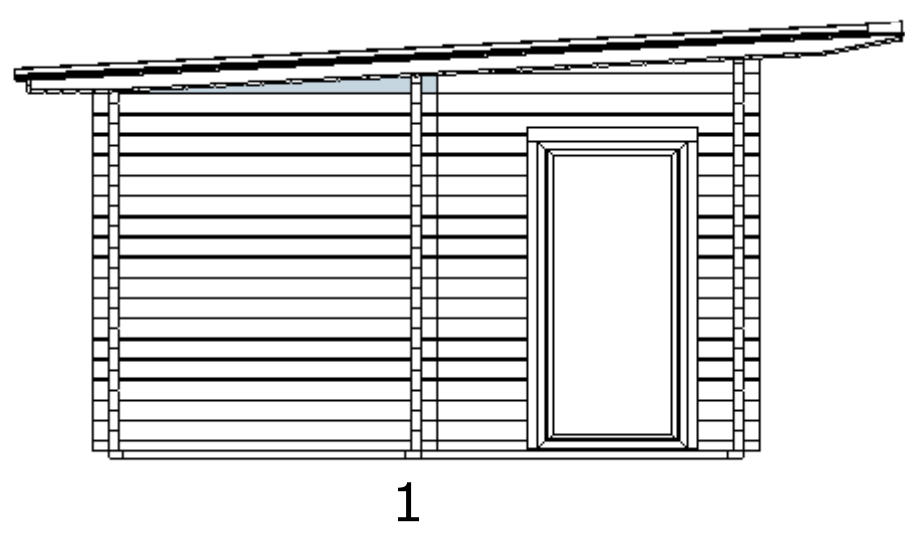
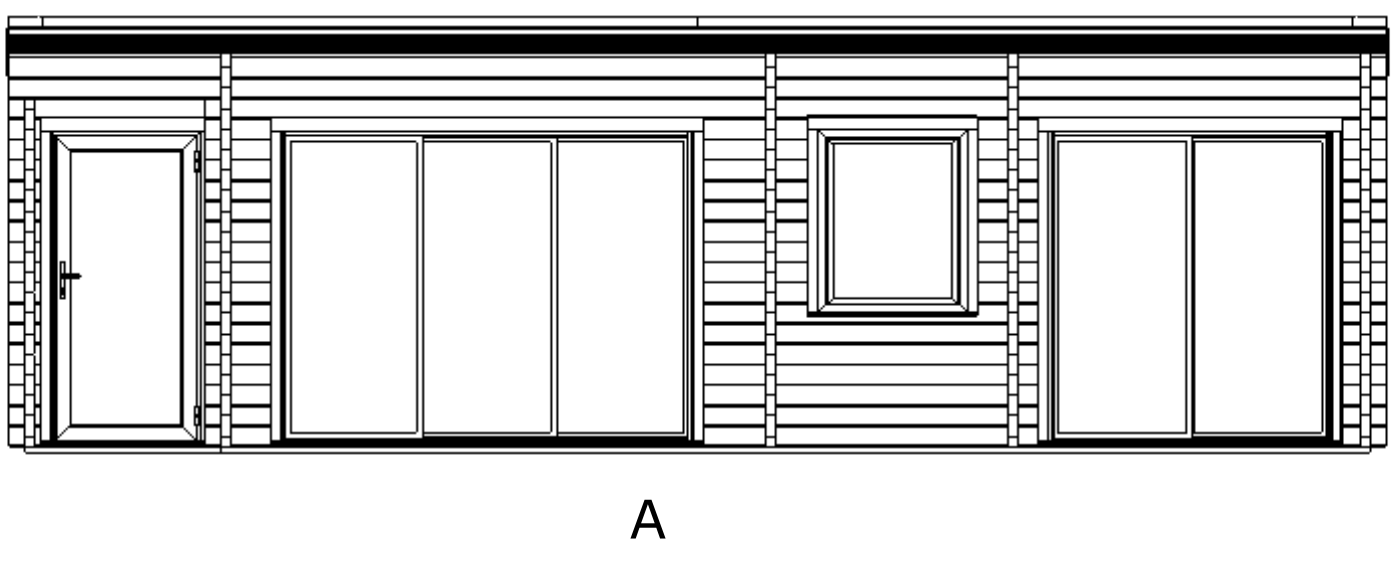
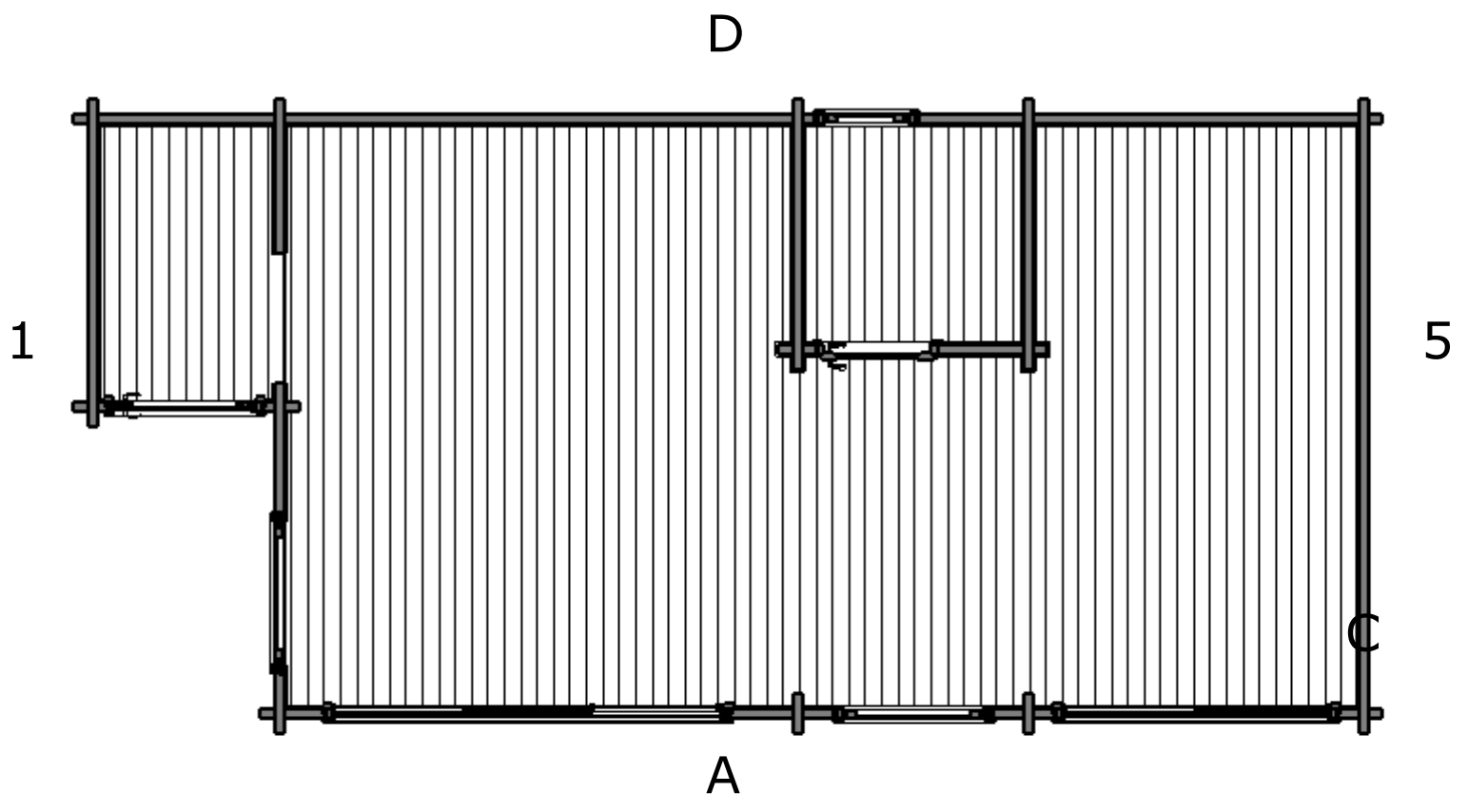

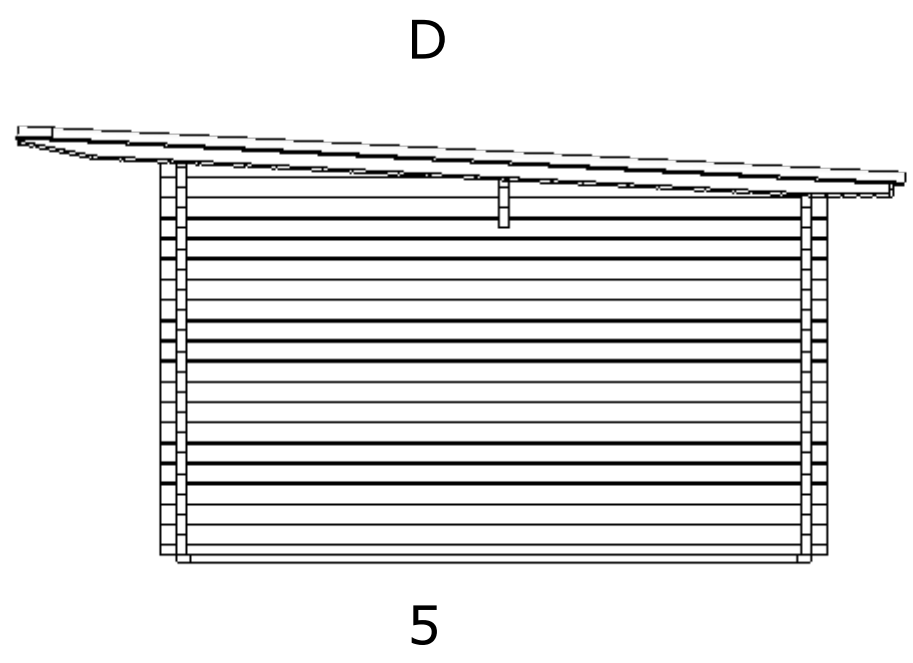
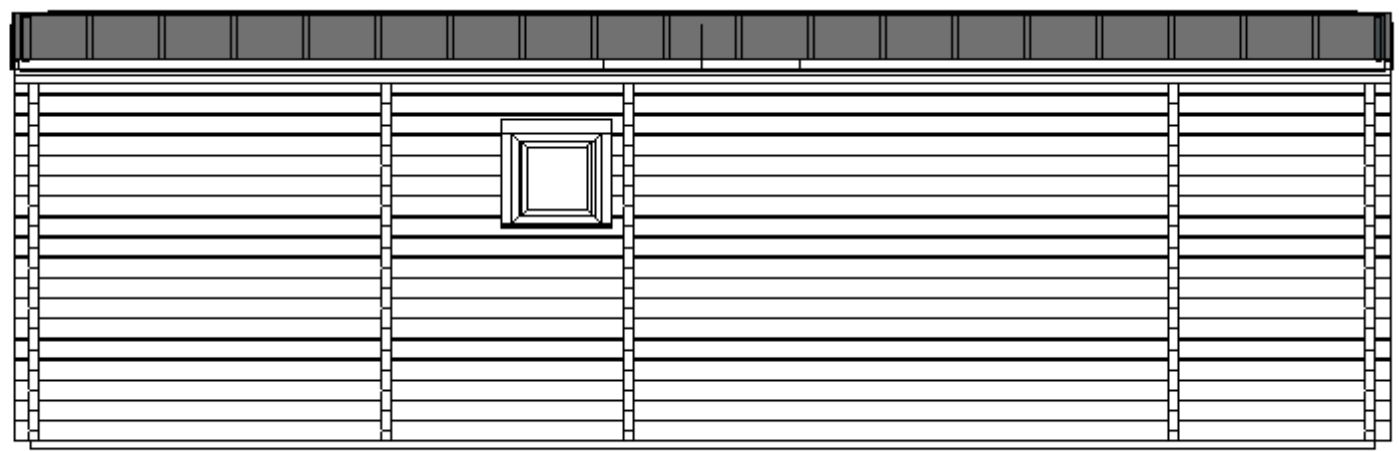
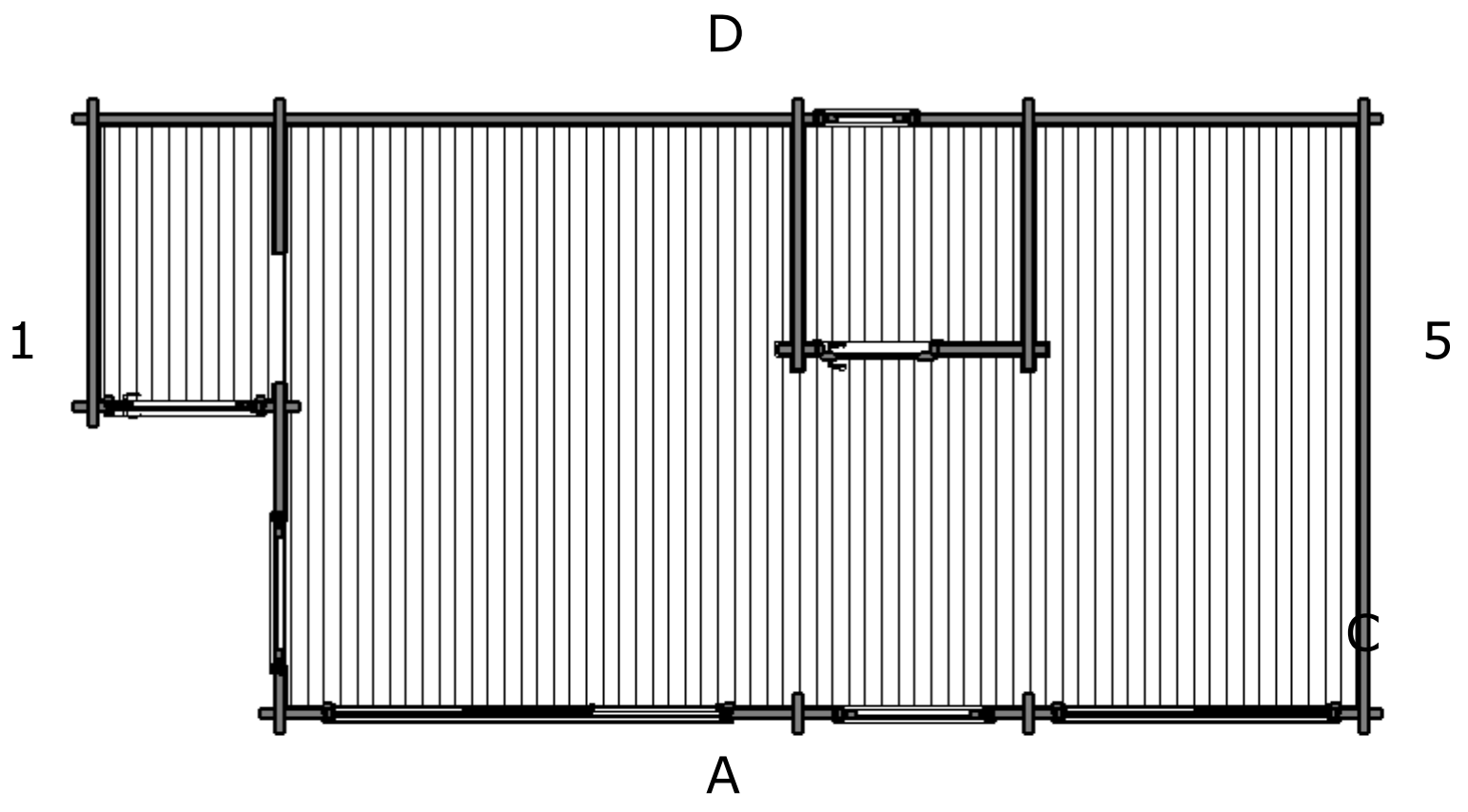

Plan: 1 Foundation  
Positions: AR1, AR2, ....

 QKRPP6x160ZnTX-1

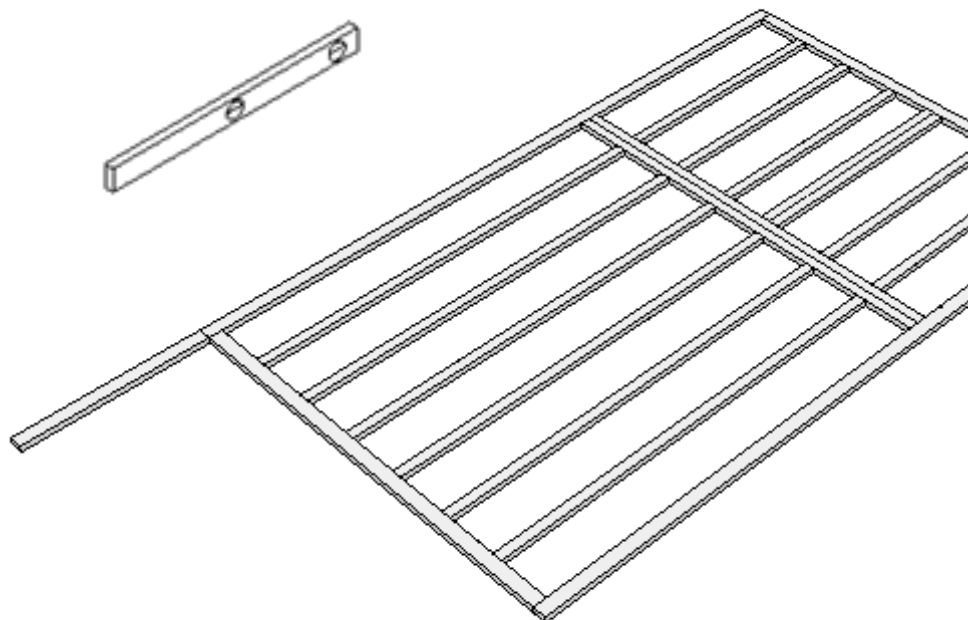

**NOT INCLUDED**

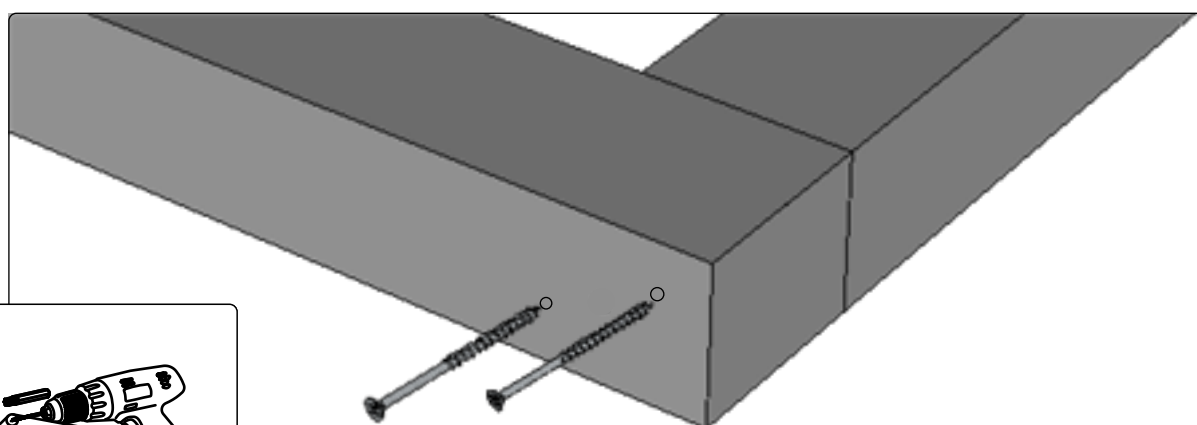
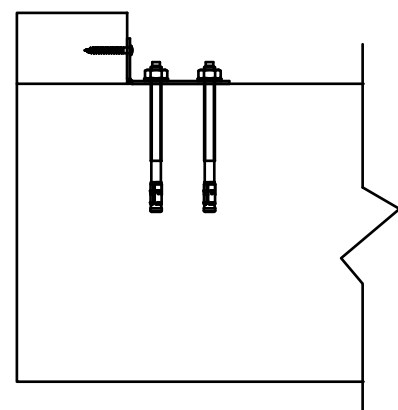
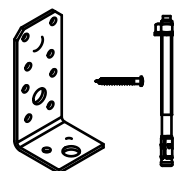

**1**

Plan: 1 Foundation + walls  
Positions: AR1, AR2, ...+ LOGS

 QKRYP5X40ZnTX

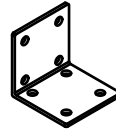

QNU20X20X40

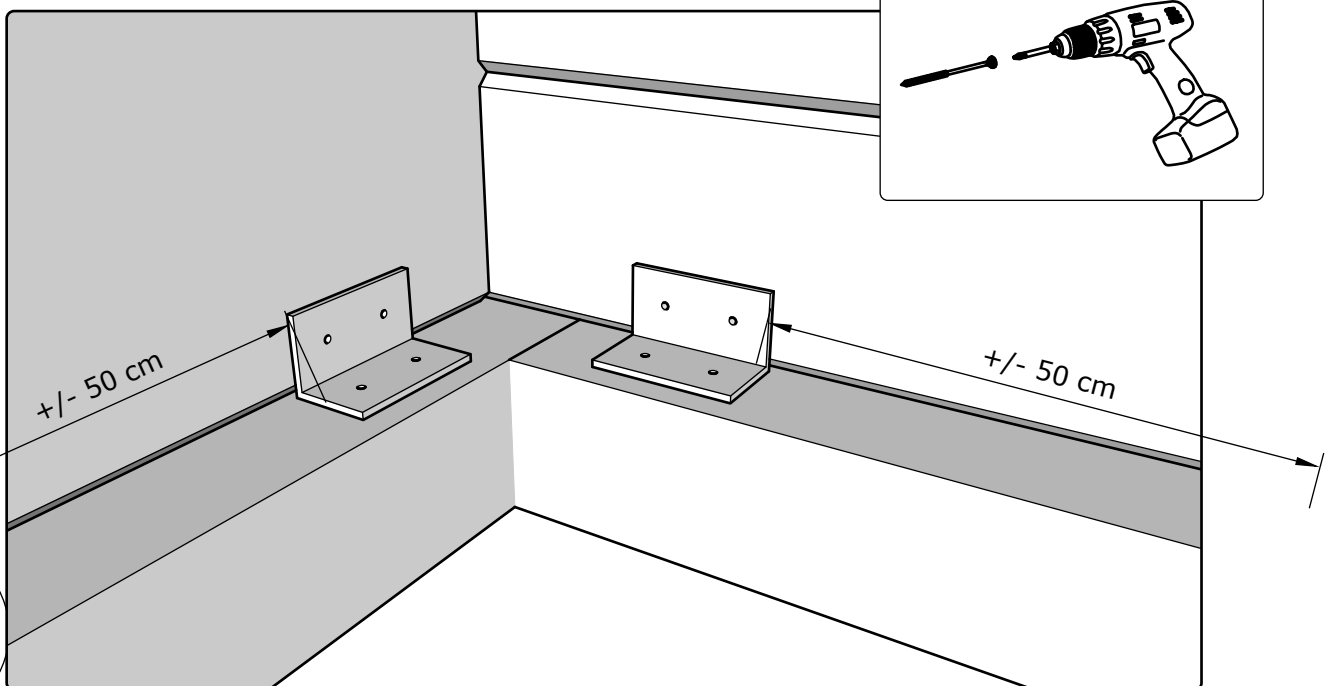
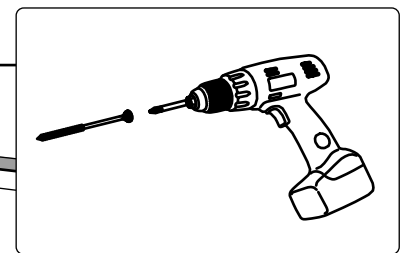
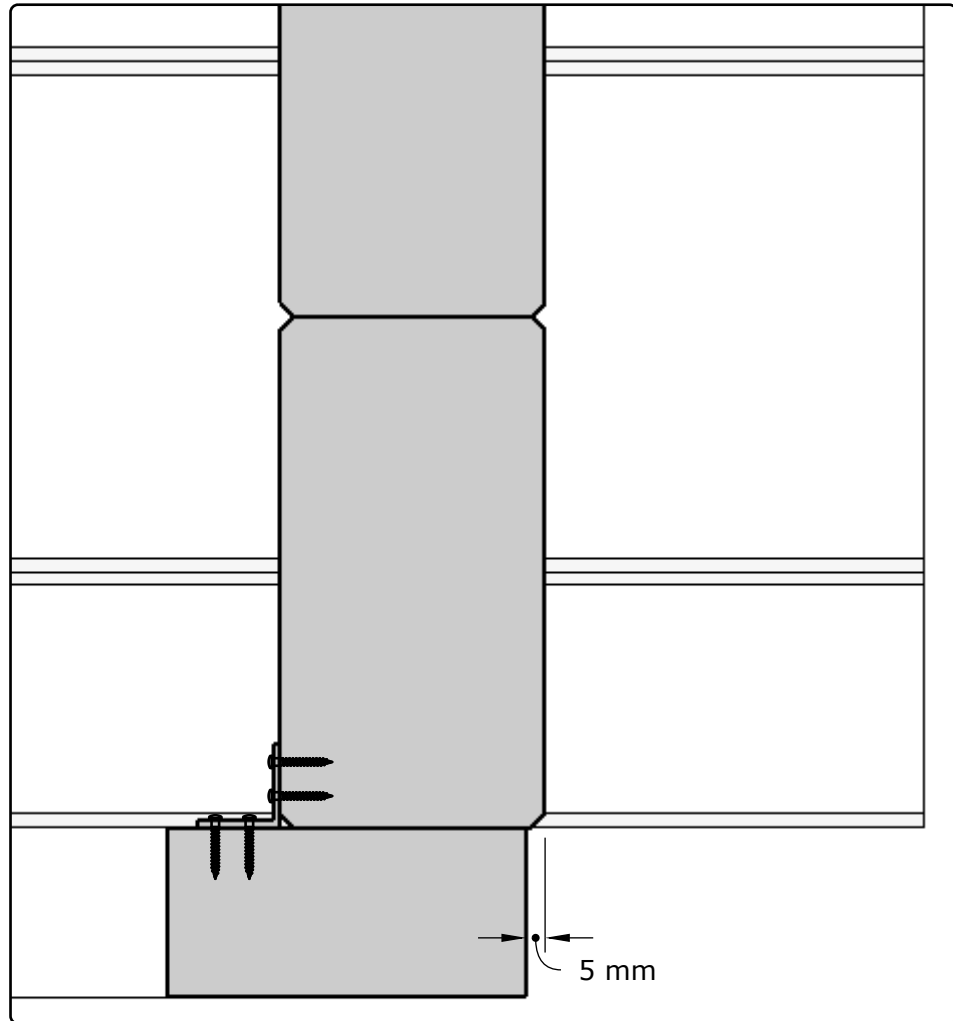
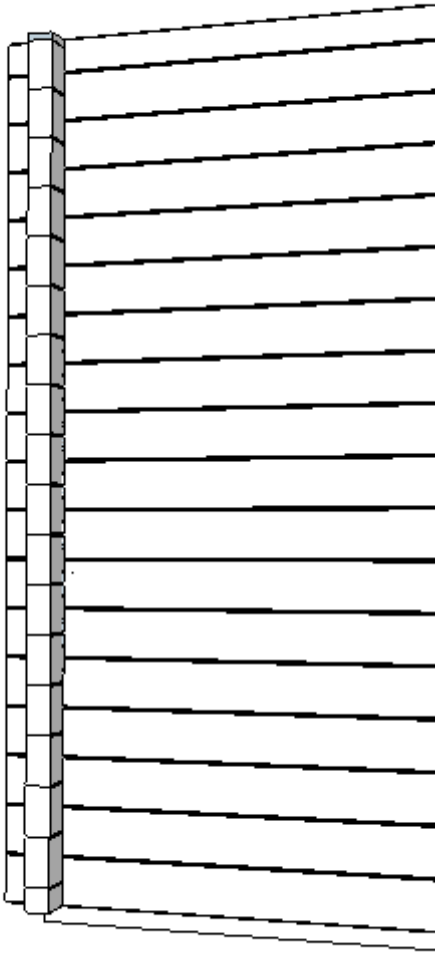

2

Plan: 2...8 Log wall assembly  
 Positions: 001,002,...045,..

**EXAMPLE**

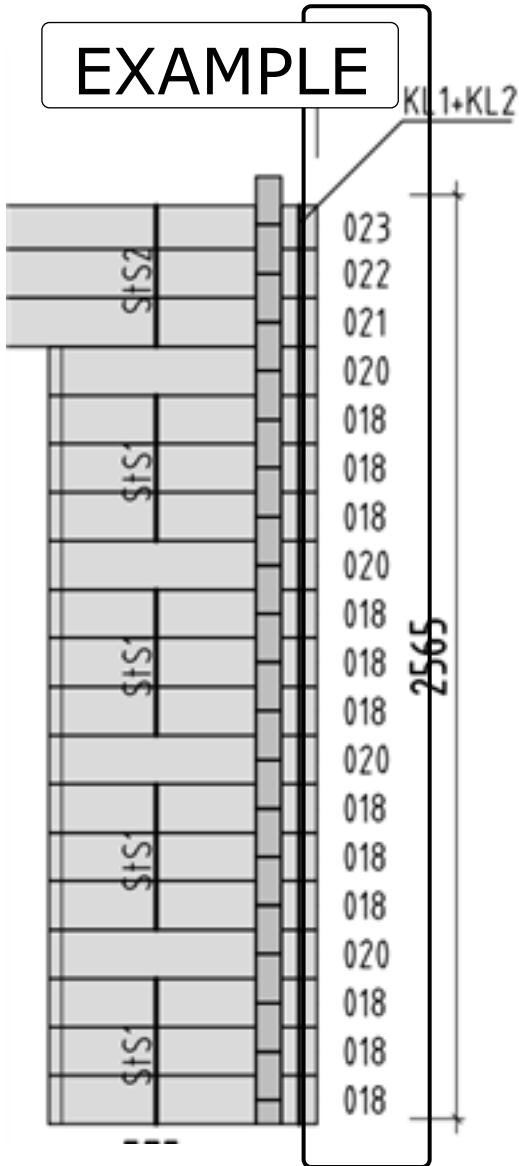

Pos	SPECIFICATION-STÜCKLISTE-NOMENCLATURE-ELEMENTI-ESPECIFICACIÓN PM70-5233	Pcs	Profile (mm)	Length (mm)
001		5	70x135	5200
002		7	70x135	5200
003		4	70x135	5200

**EXAMPLE**



Plan: 2...8 Log wall assembly

Positions: 001,002,...045,...

StS1, StS2,....

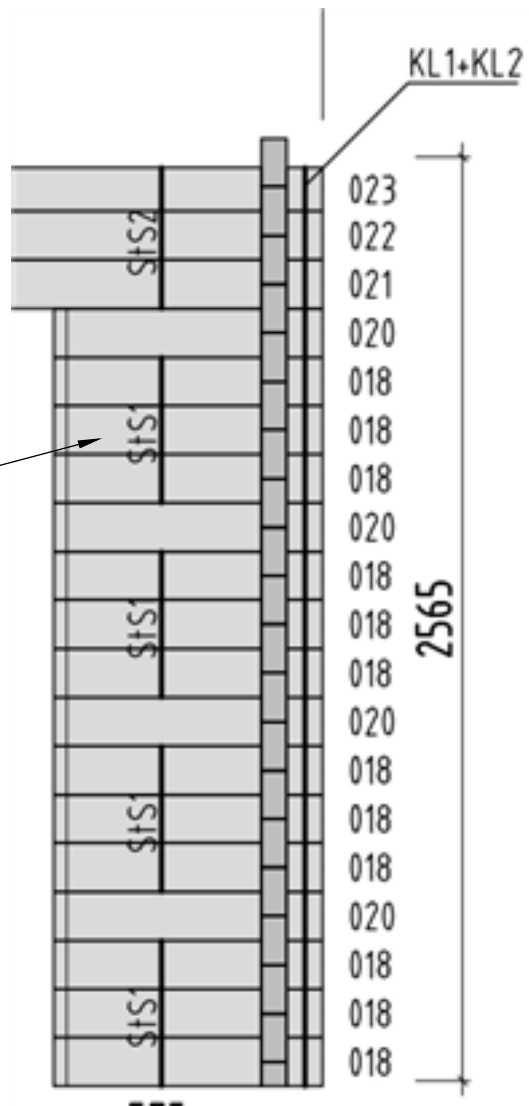
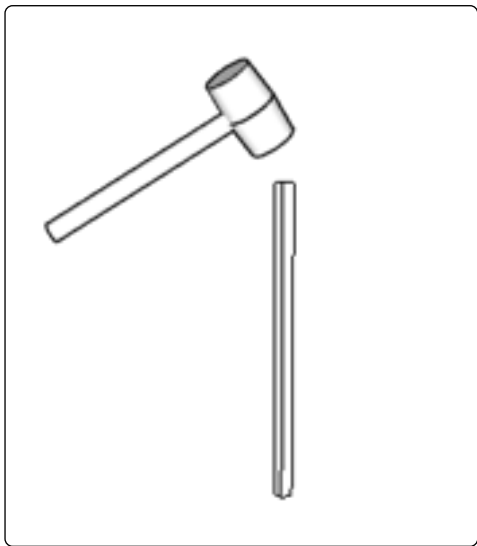

Plan: 2...8 Log wall assembly

Positions: 001,002,...045,...

(QMUPL10Zn)x4

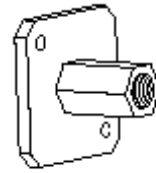

(QSE10Zn)x4



KL1, KL2,...



(QMUJ10Zn)x4



(QMUKK10Zn)x4

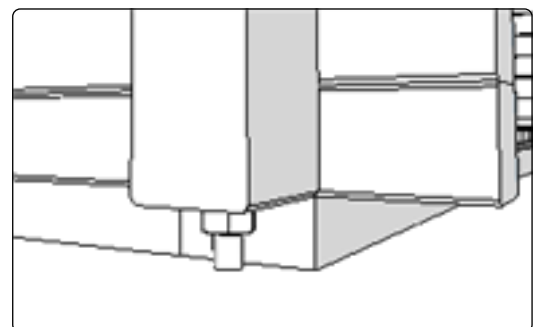
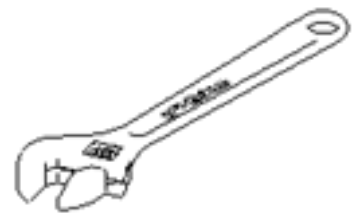
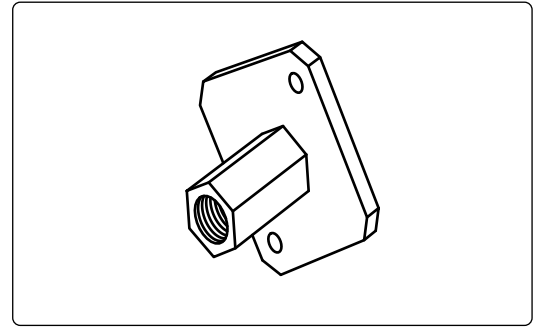
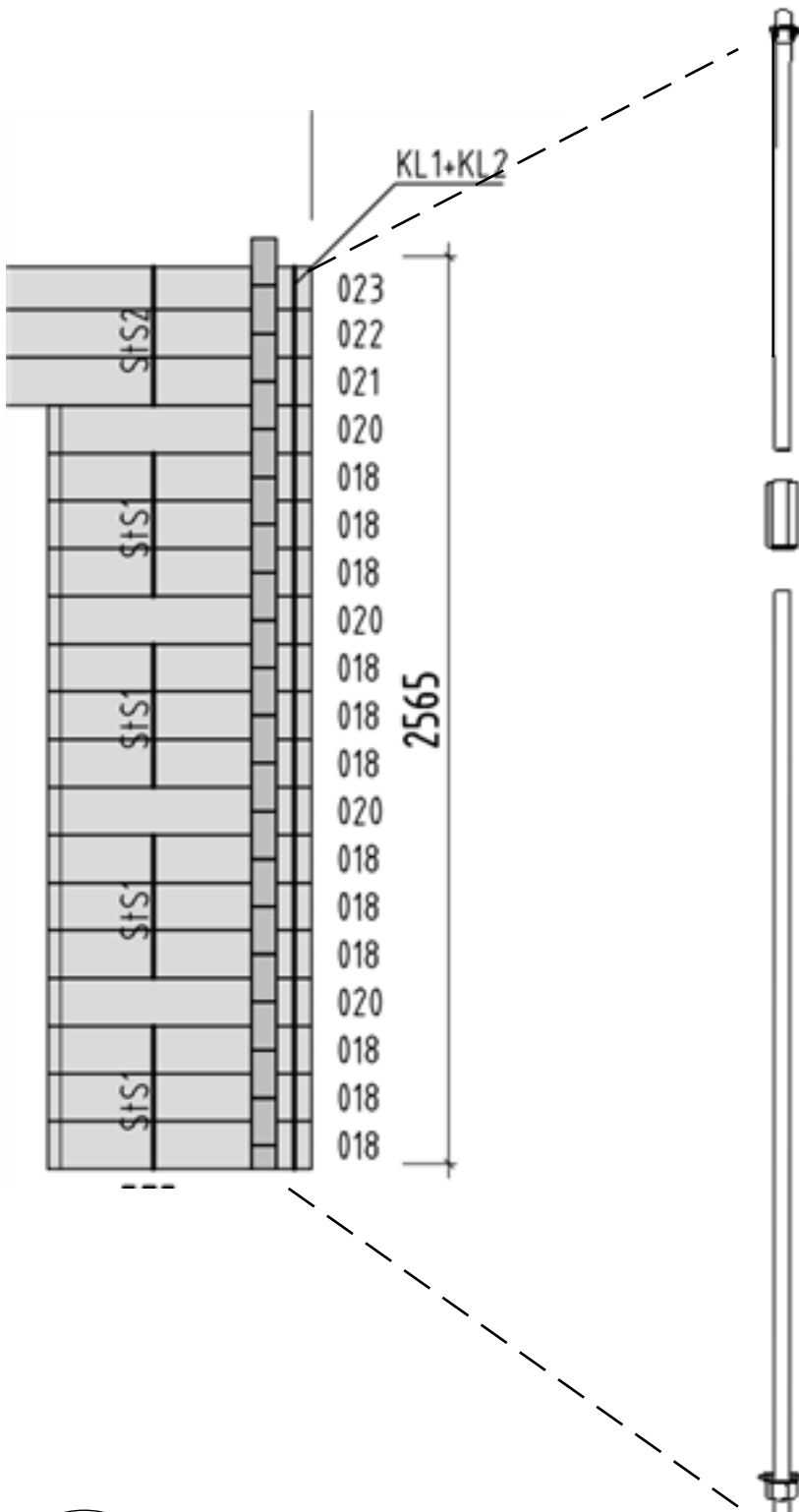

Plan: 8\_3 WALL5

Positions: Pst

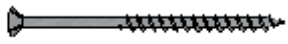

10 (QKRPP4\_5X70Zn)

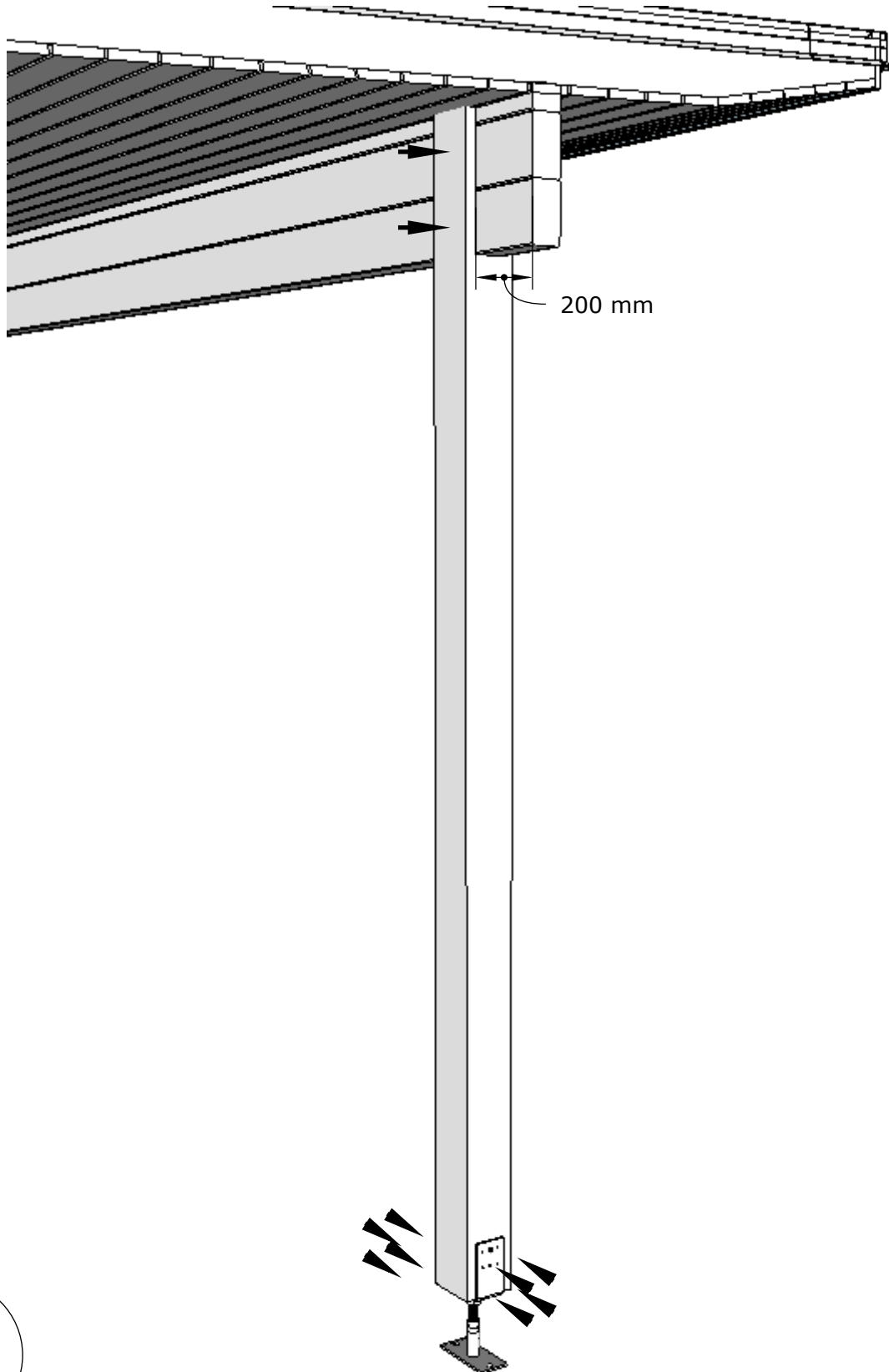
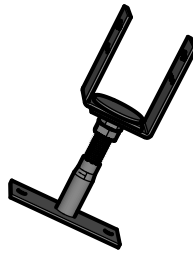

6

Plan: 9 Rafter plan  
Positions: RoR1



QKRYP8x260Zn

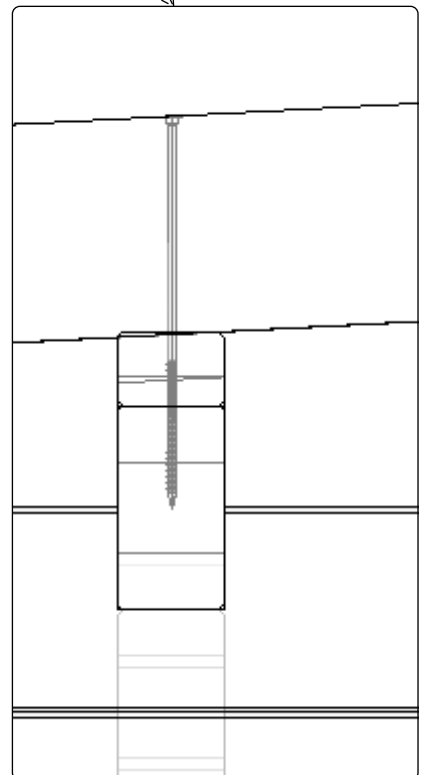
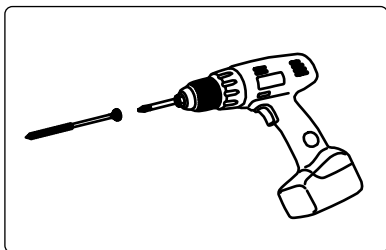
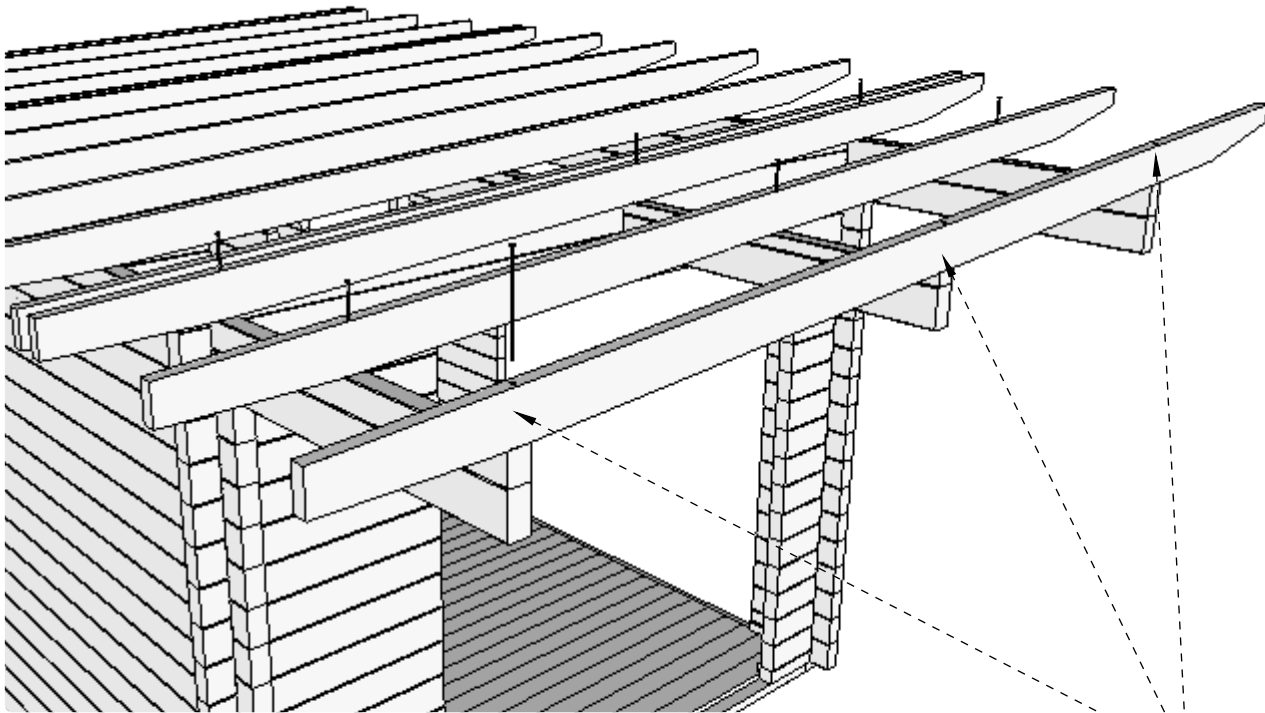

Plan: 9 Rafter plan

Positions: RoR1

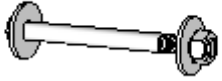

QPOKK8X60ZN

QSE8X28ZN

QMUKK8ZN

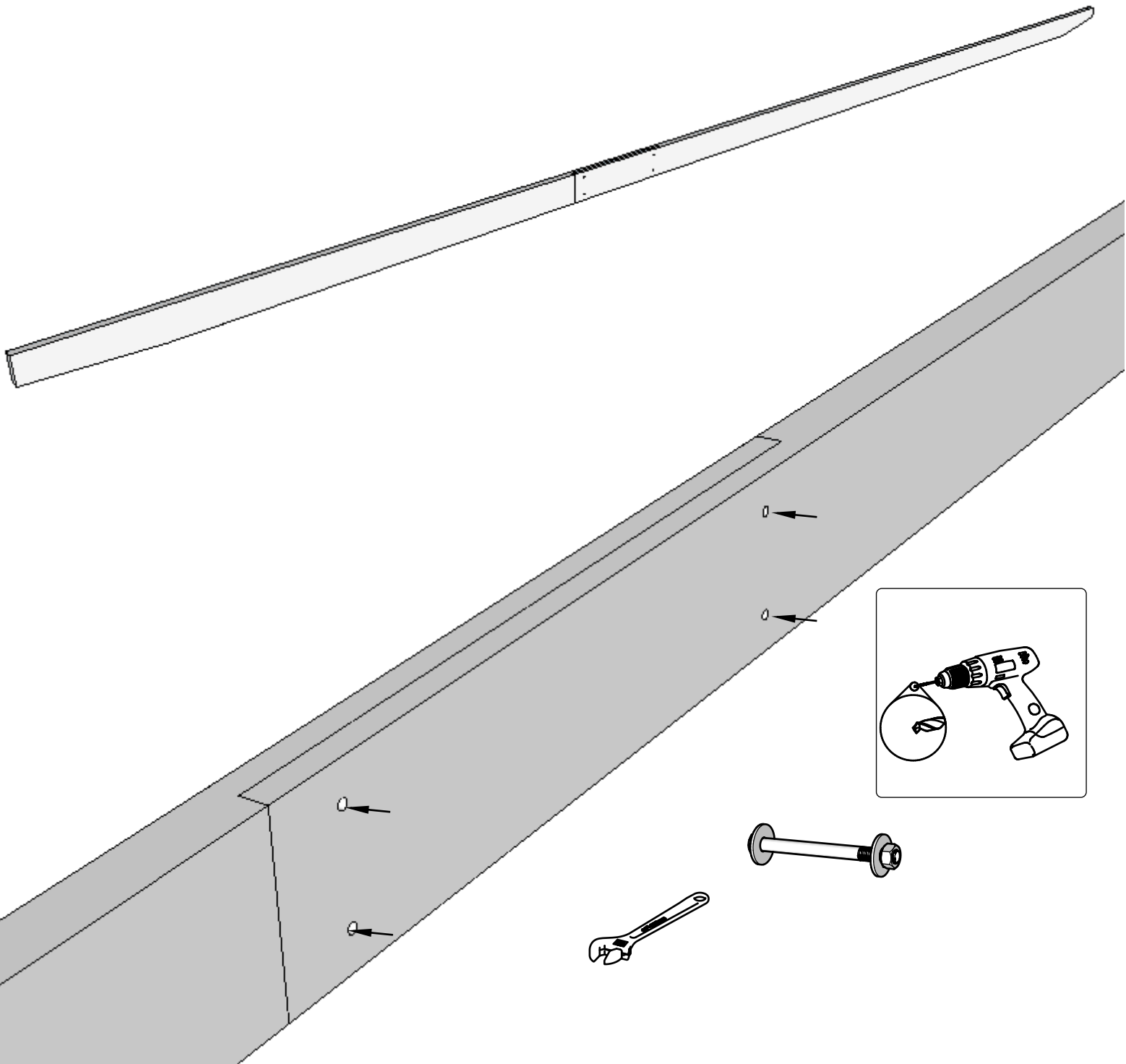

Plan: 9 Rafter plan

Positions: RoR2

 QKRPP4\_5X70Zn

RoR2

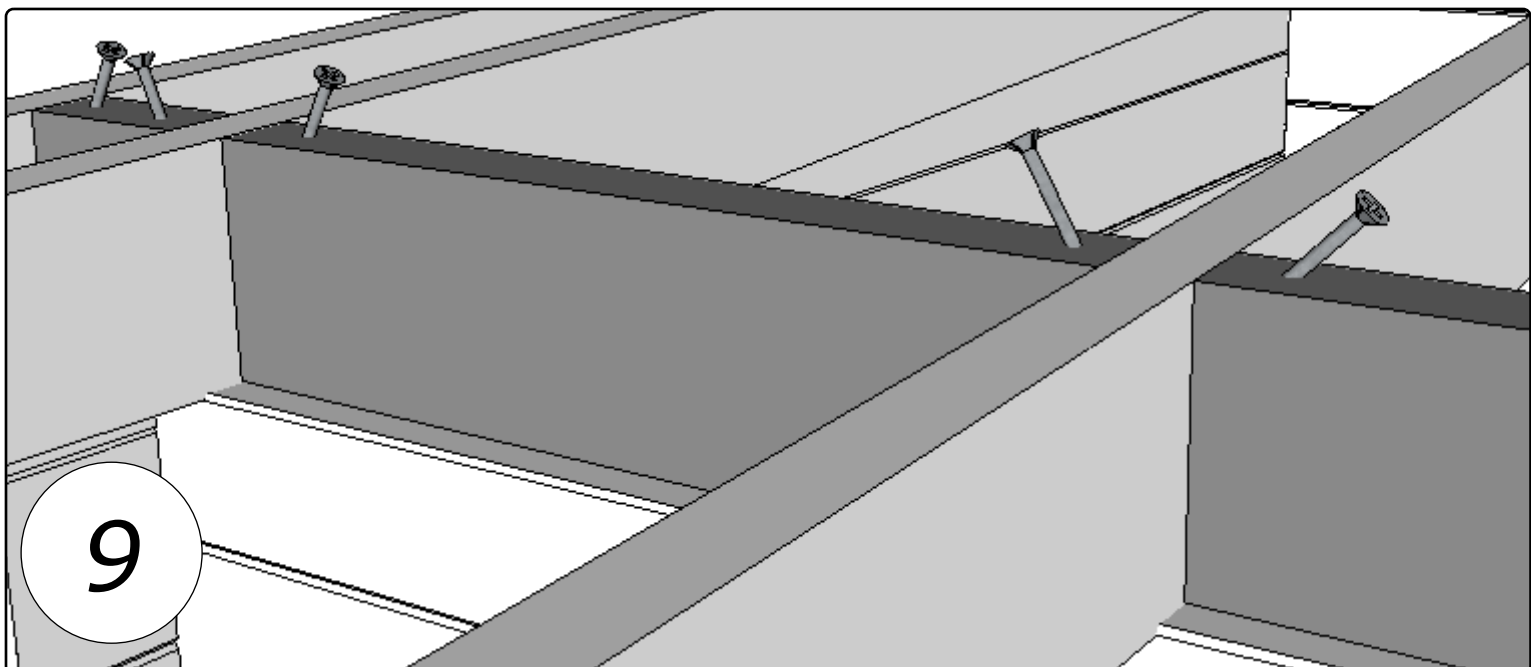
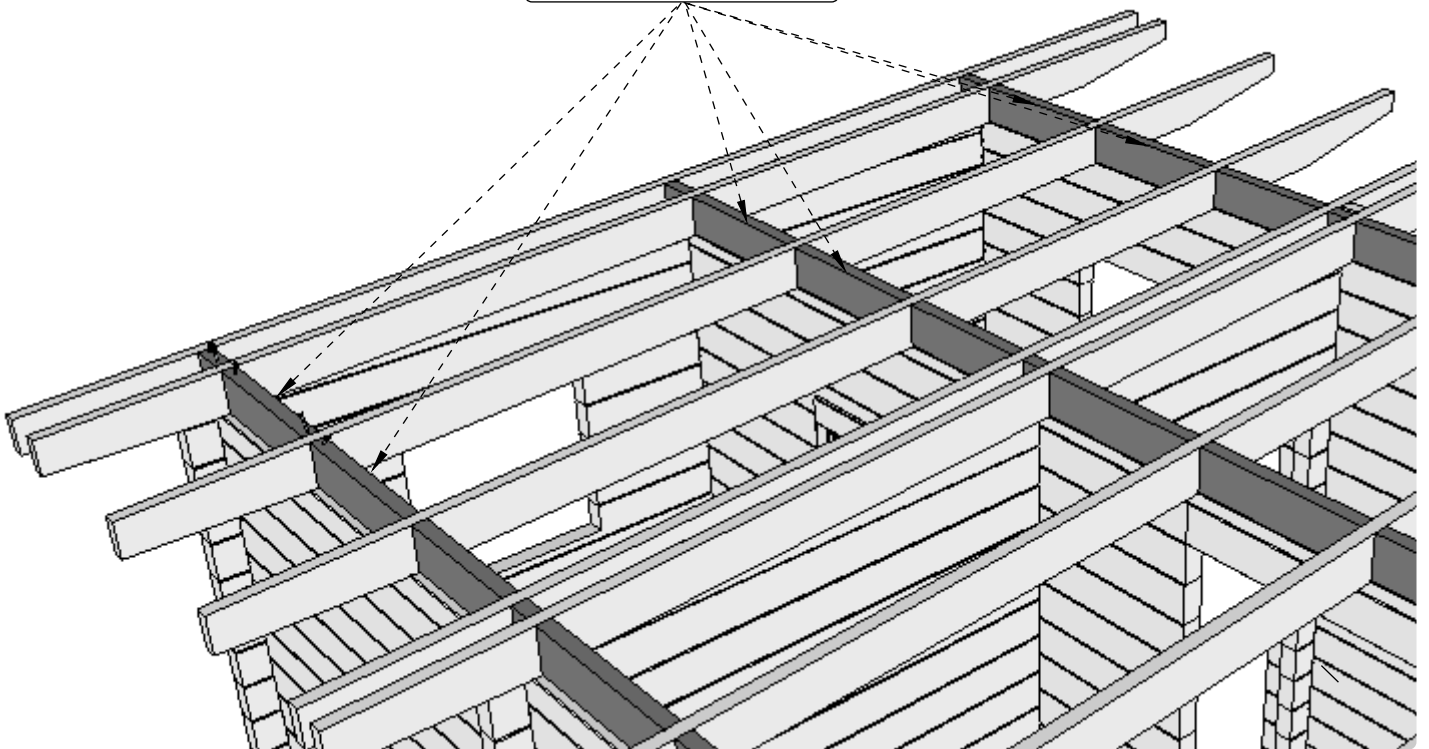
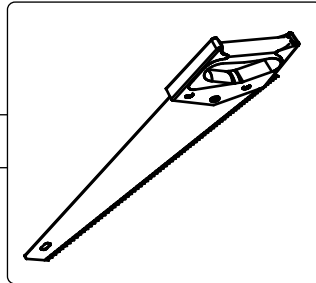

Plan: 10 Roof plan  
Positions: RB2-1, RB2 - 2

 QNA2\_2x50Zn

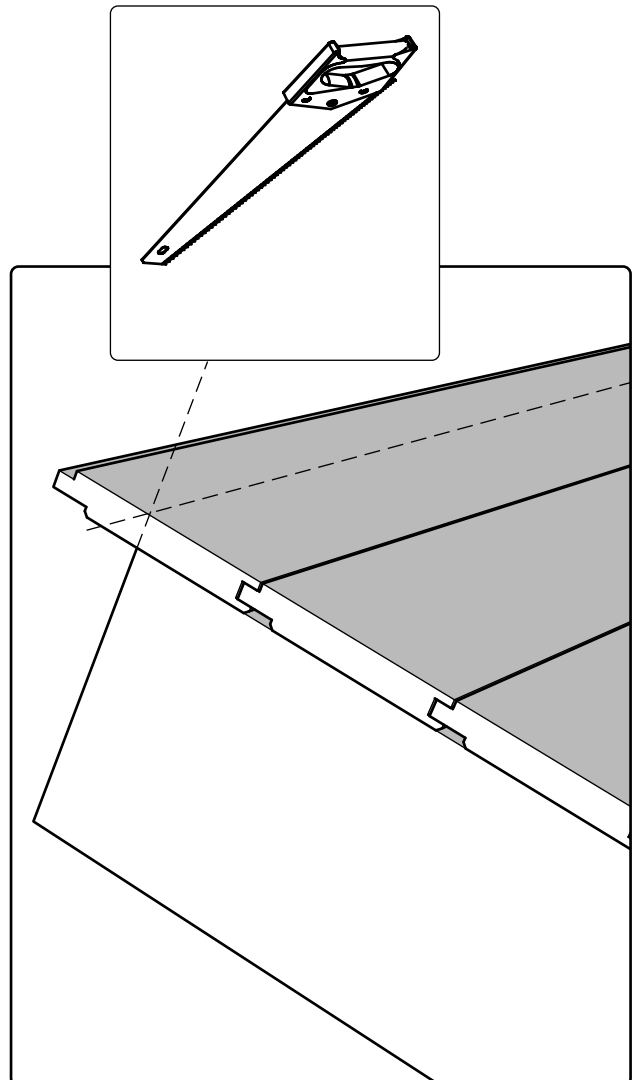
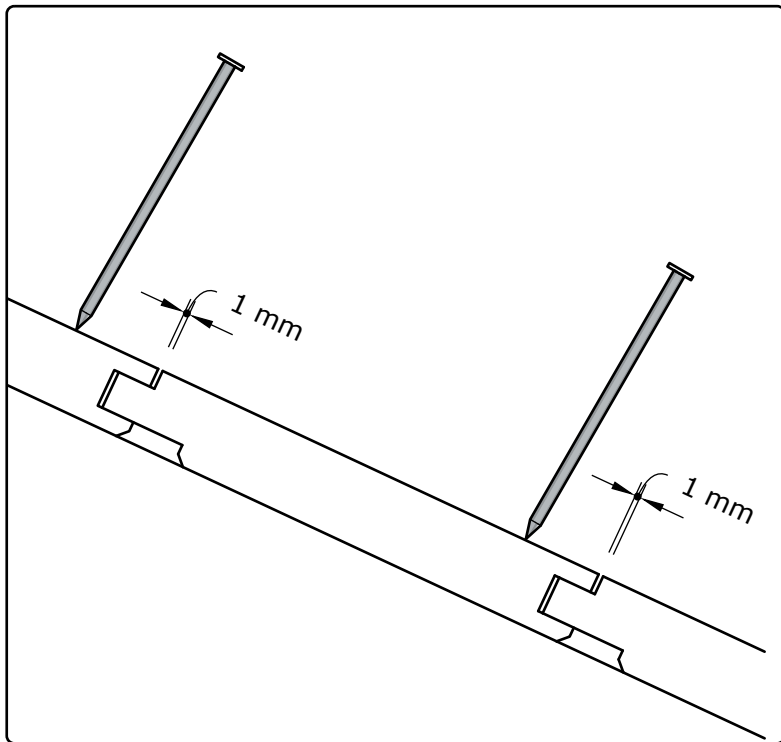
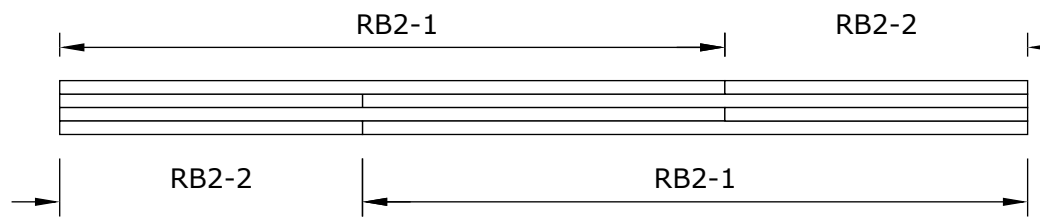
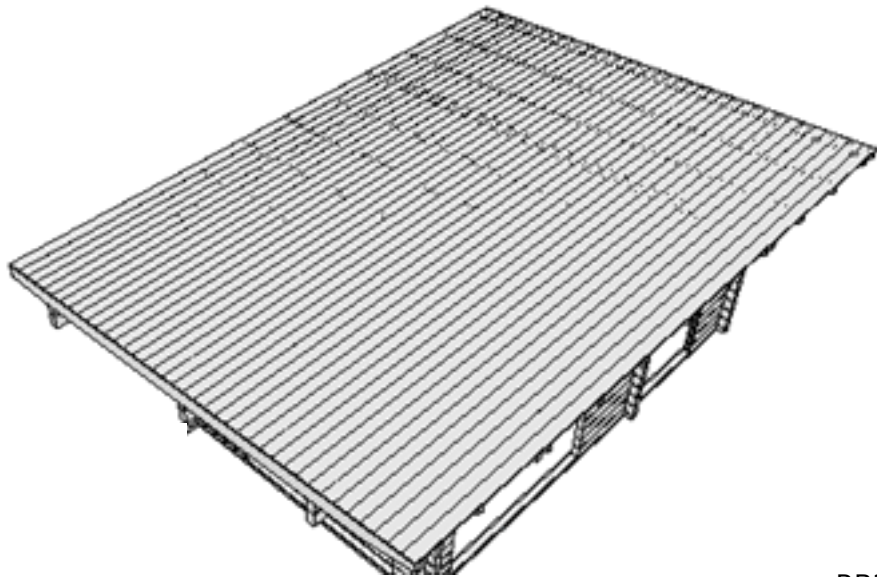

10

Plan: 11 Roof overhang boarding plan

Positions: TB3-1, TB3-2, TB3-3, EaE1, EaE2, EaE3, EaE4

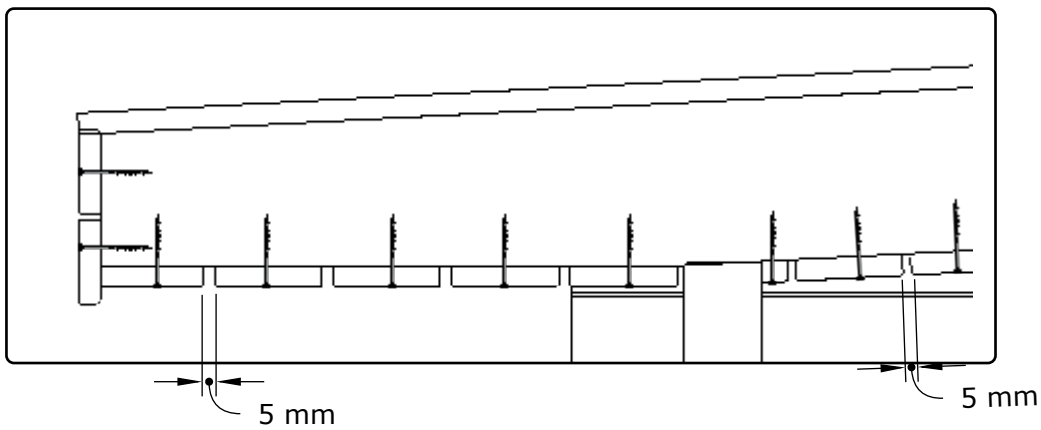
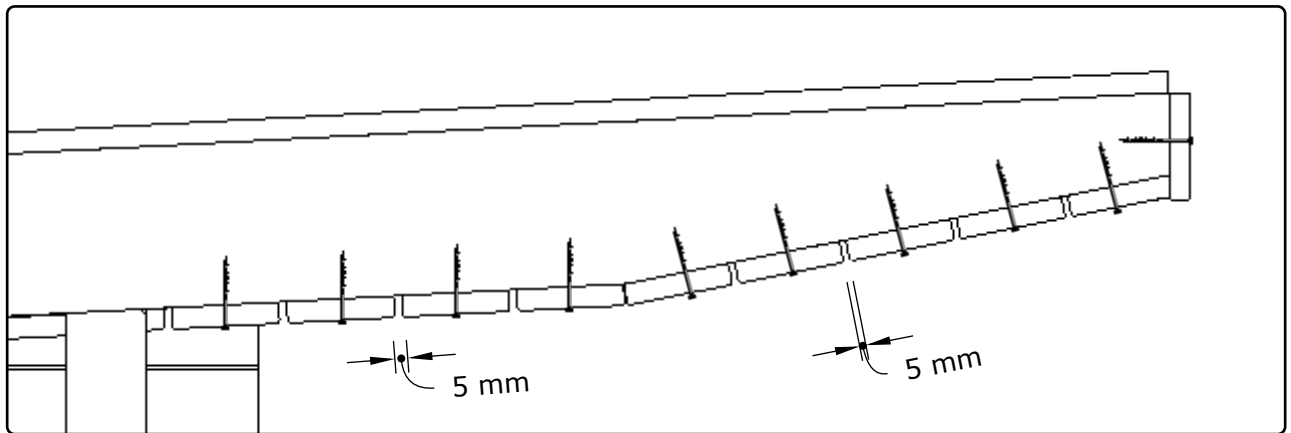
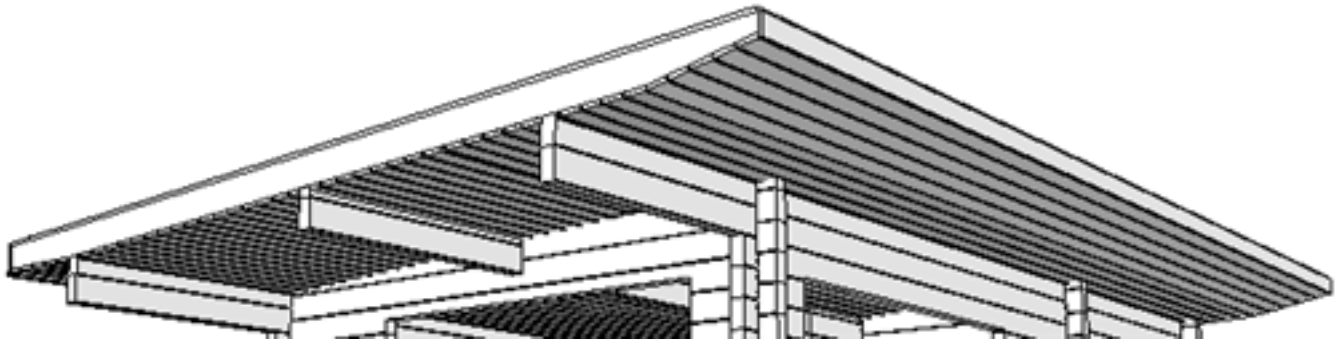



Plan: 11 Roof  
Positions:

QP151x52\_4x2000MU

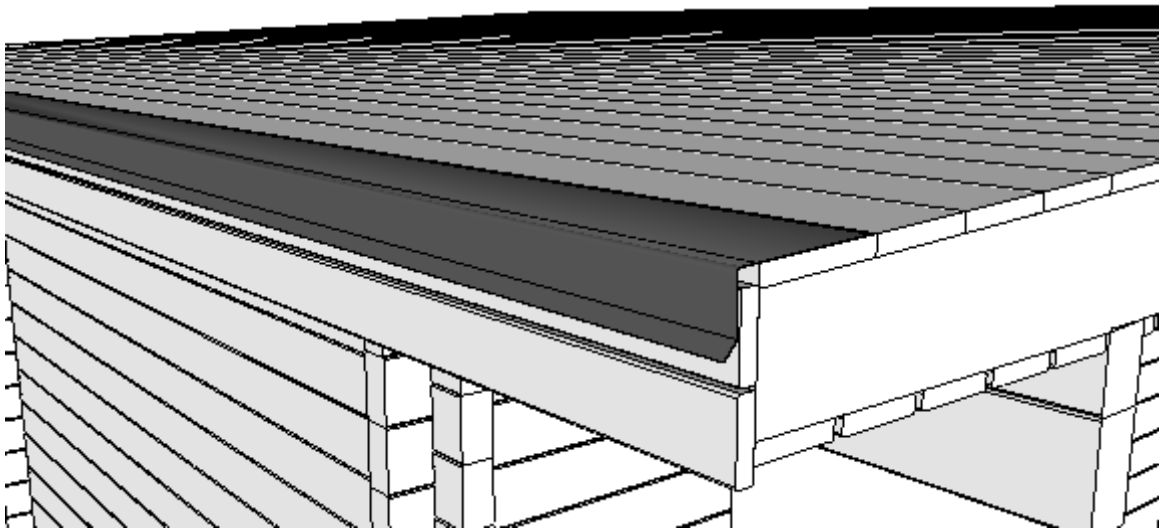
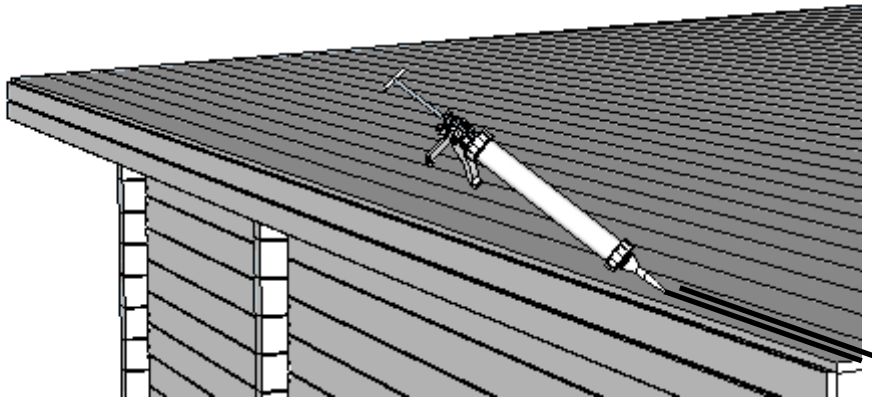
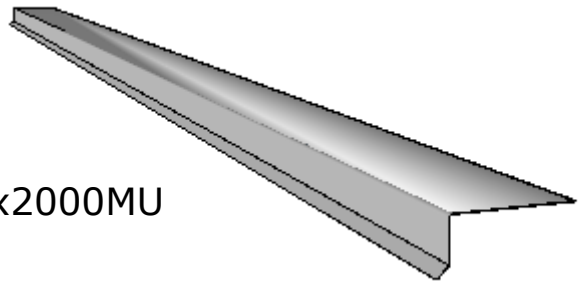

EPDM optional

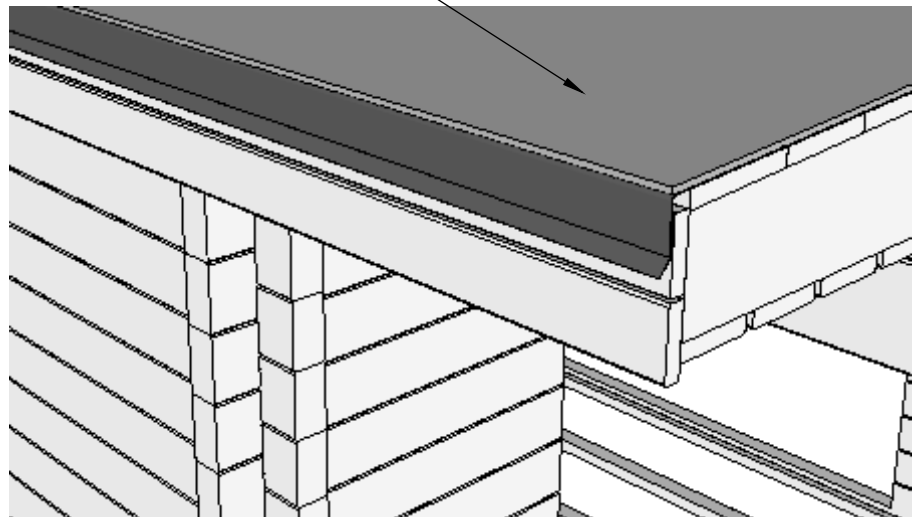

Plan: 11 Roof  
Positions:

QKRKK4\_8X28MU



QP151x52\_4x2000MU

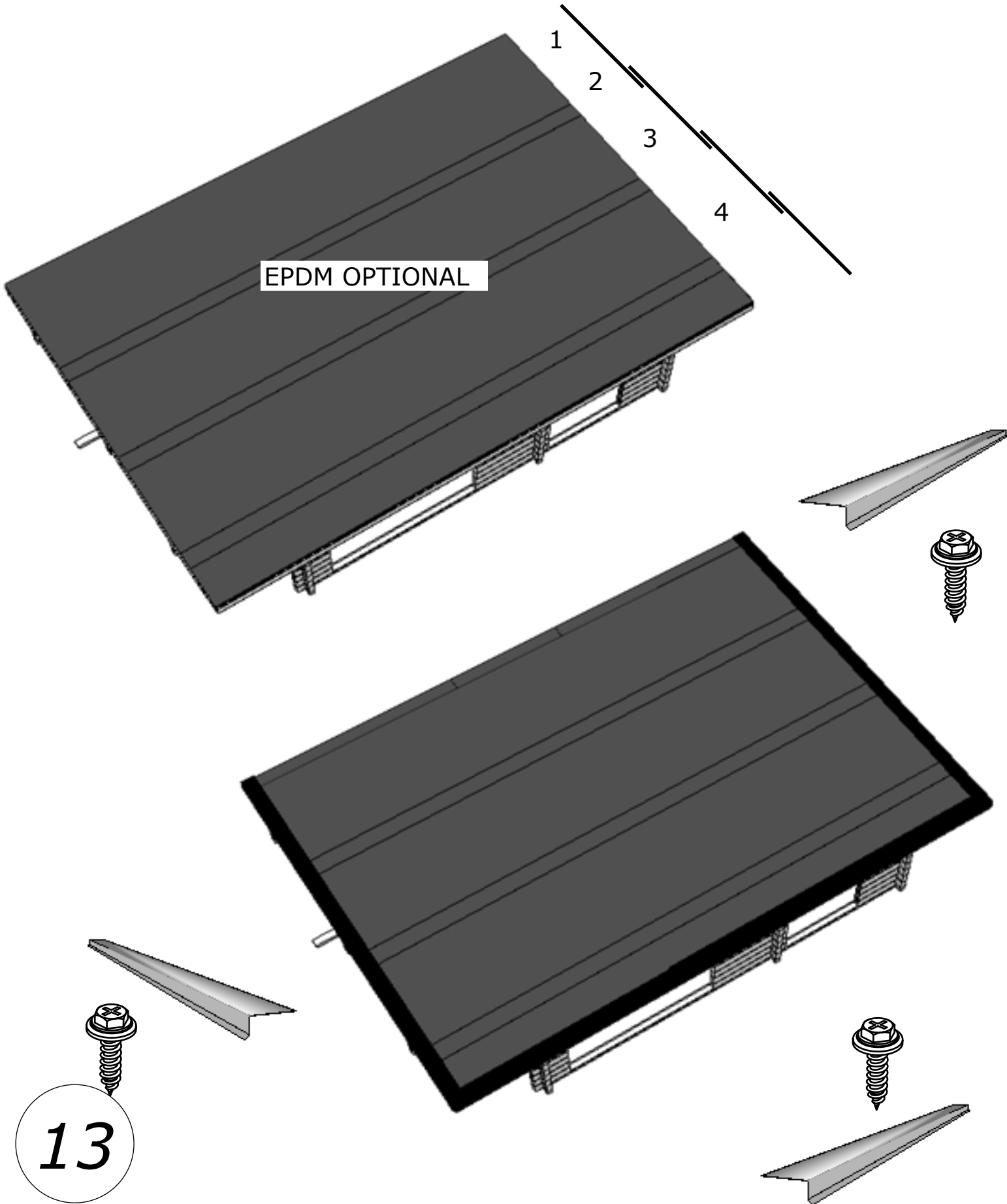
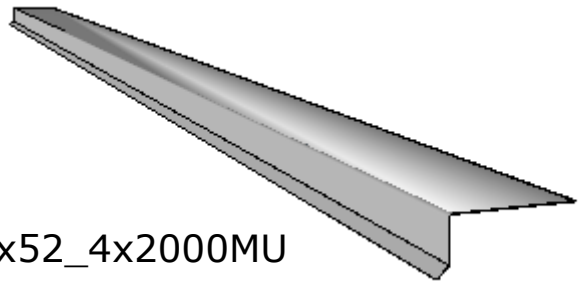

EPDM OPTIONAL

1  
2  
3  
4

13

Plan: 11 Roof  
Positions:

QKRKK4\_8X28MU



QP151x52\_4x2000MU

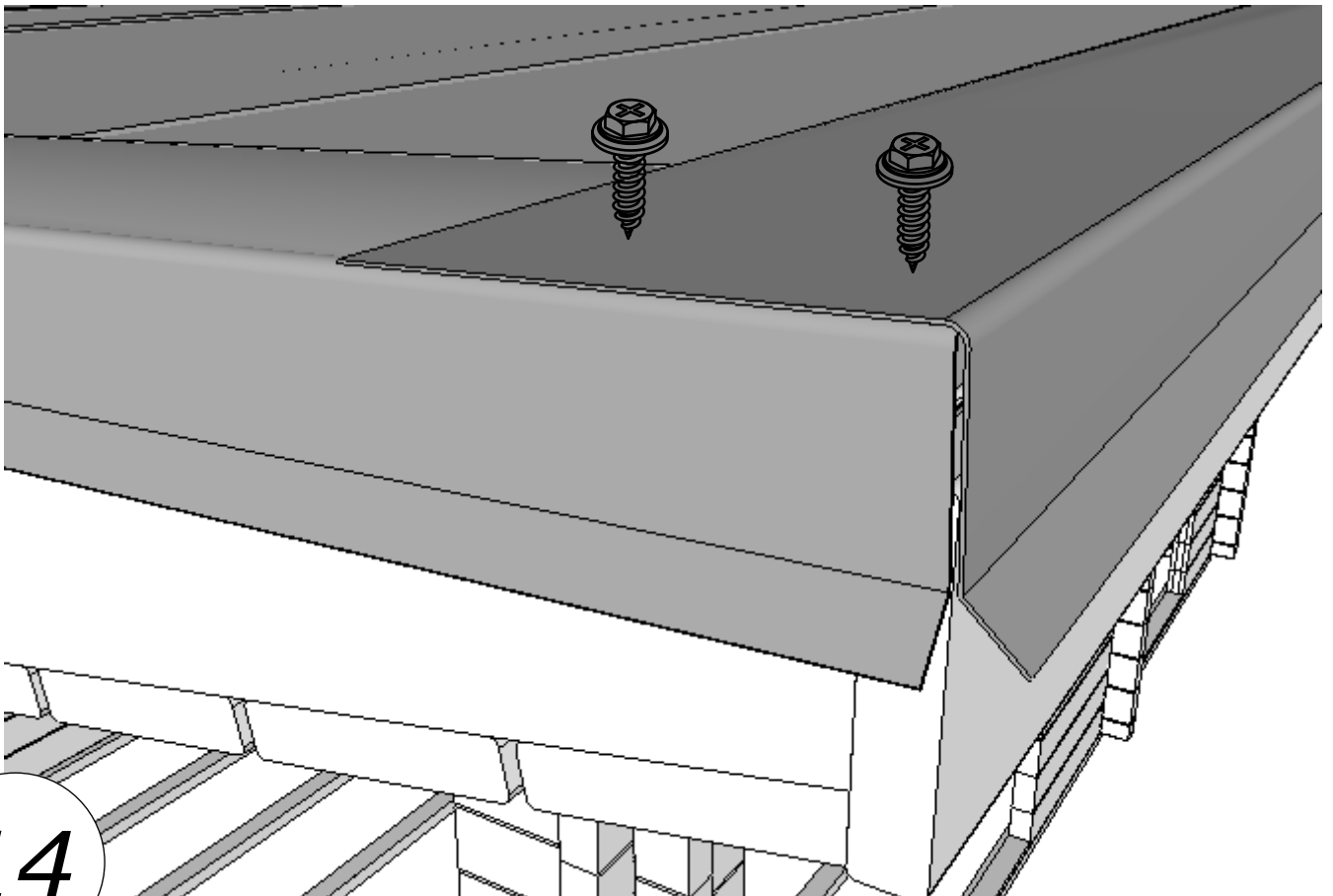
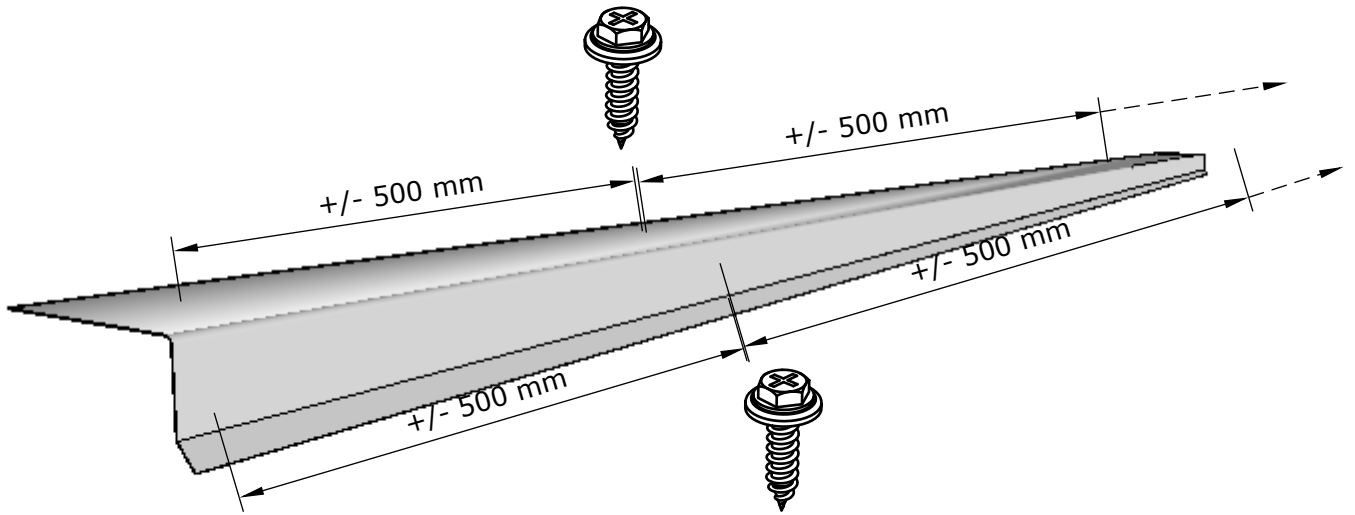
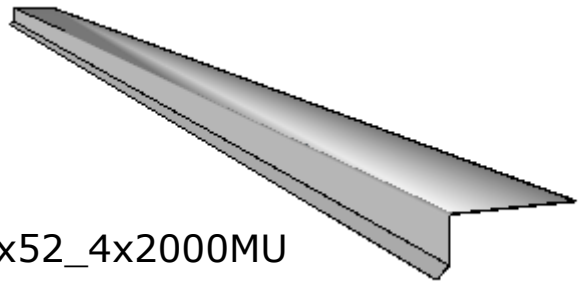

Plan: 9 Rafter plan  
Positions:

## Recommmended, NOT included

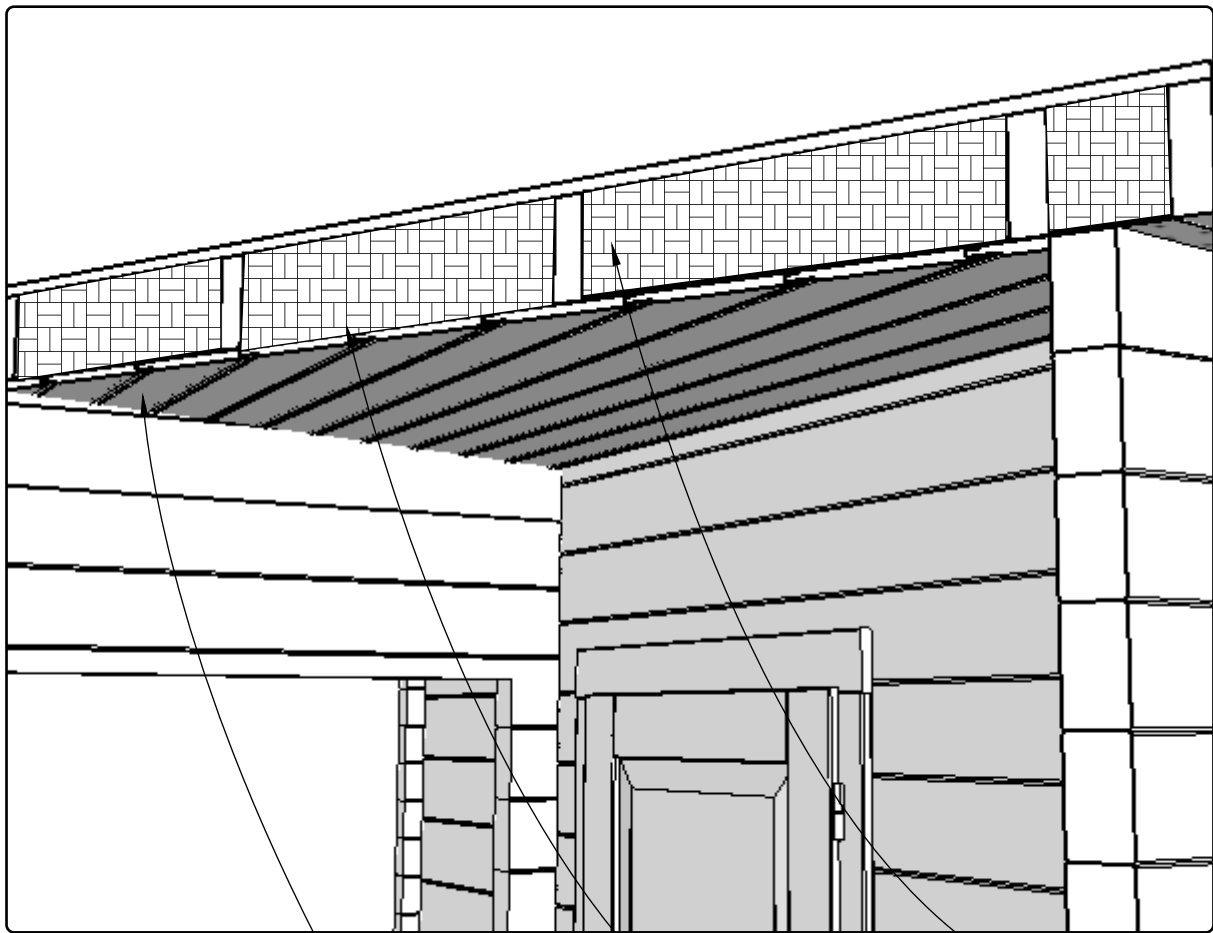

• Insulation NOT INCLUDED

• Vapor barrier NOT INCLUDED

• Ceiling boarding NOT INCLUDED



Plan: 13, 14, 15 Doors - Windows  
Positions:

Plan: 14  
Positions: TU51



Exterior



I

Plan: 13-C ASI-15-7016  
Positions:

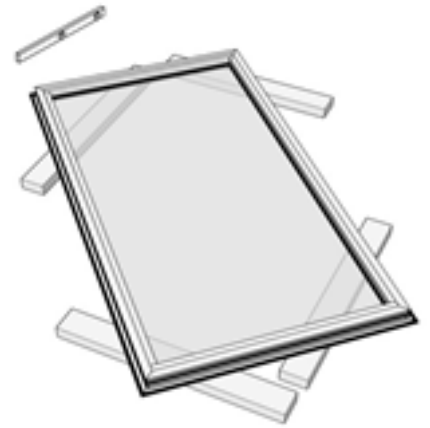

I

Plan: 13  
Positions: ASI-13

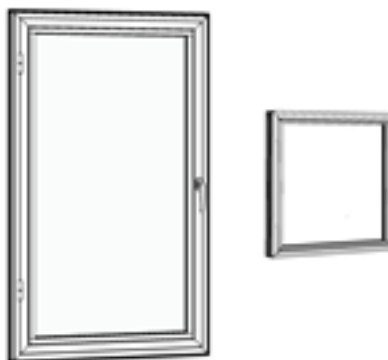

I

Plan: 15-A LU104-SP-7016  
Positions:



17

Plan: 15  
Positions: LU59-SP-7016



I

Plan: 16 Doors INSIDE  
Positions: U71

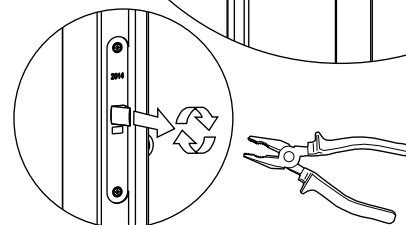
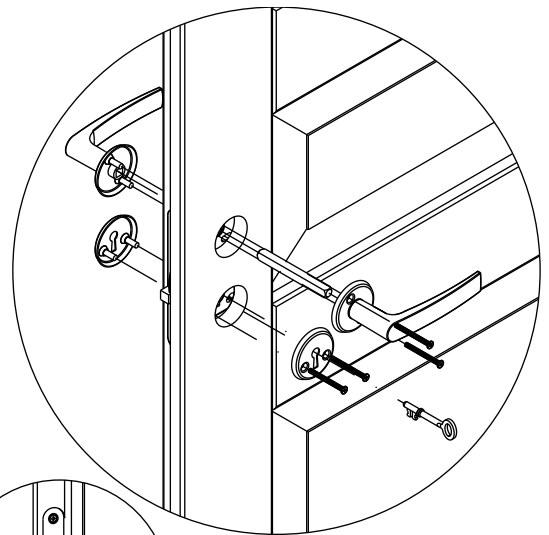
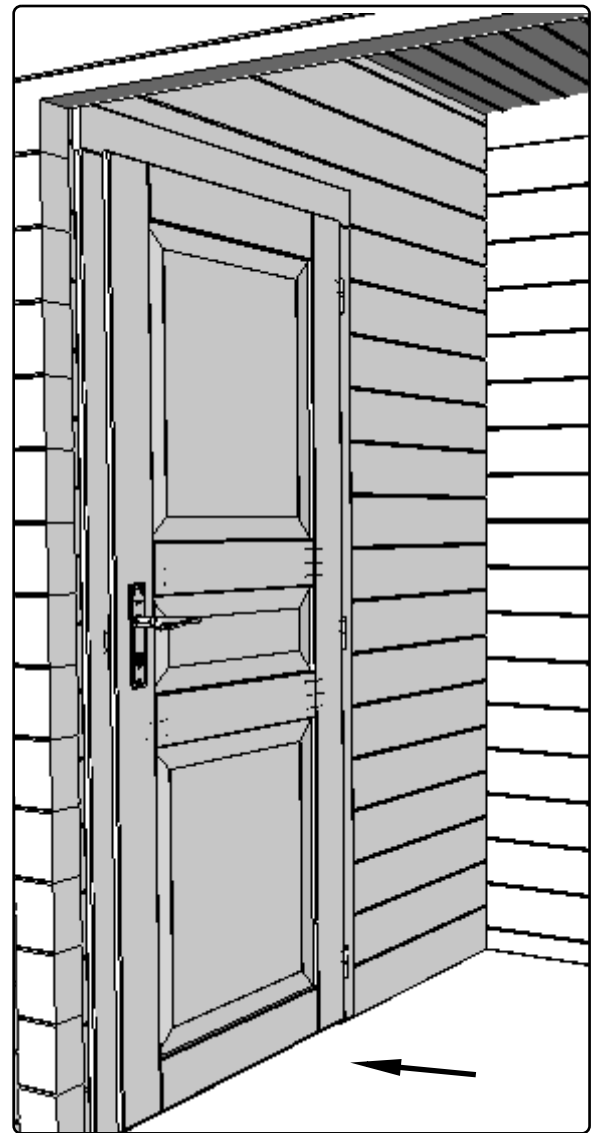
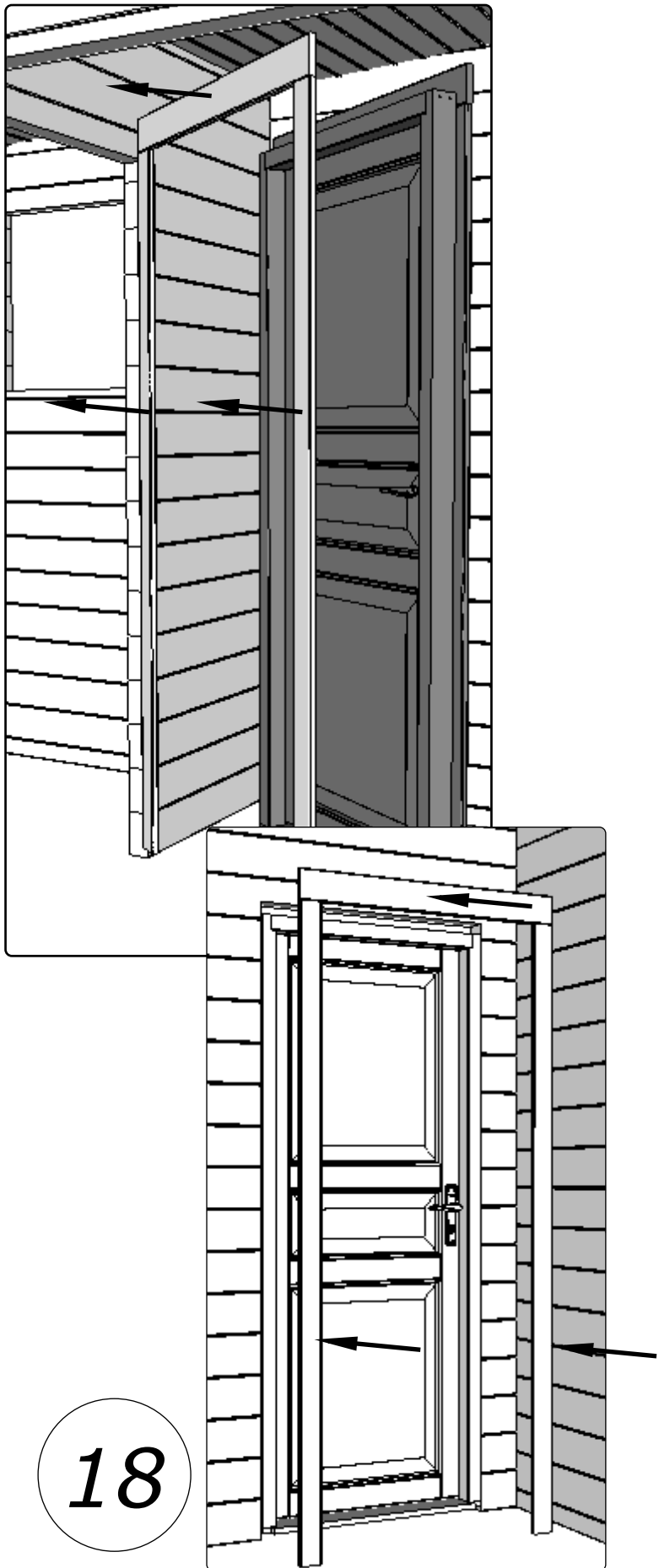

18

Plan: 17 Zalusii  
Positions:

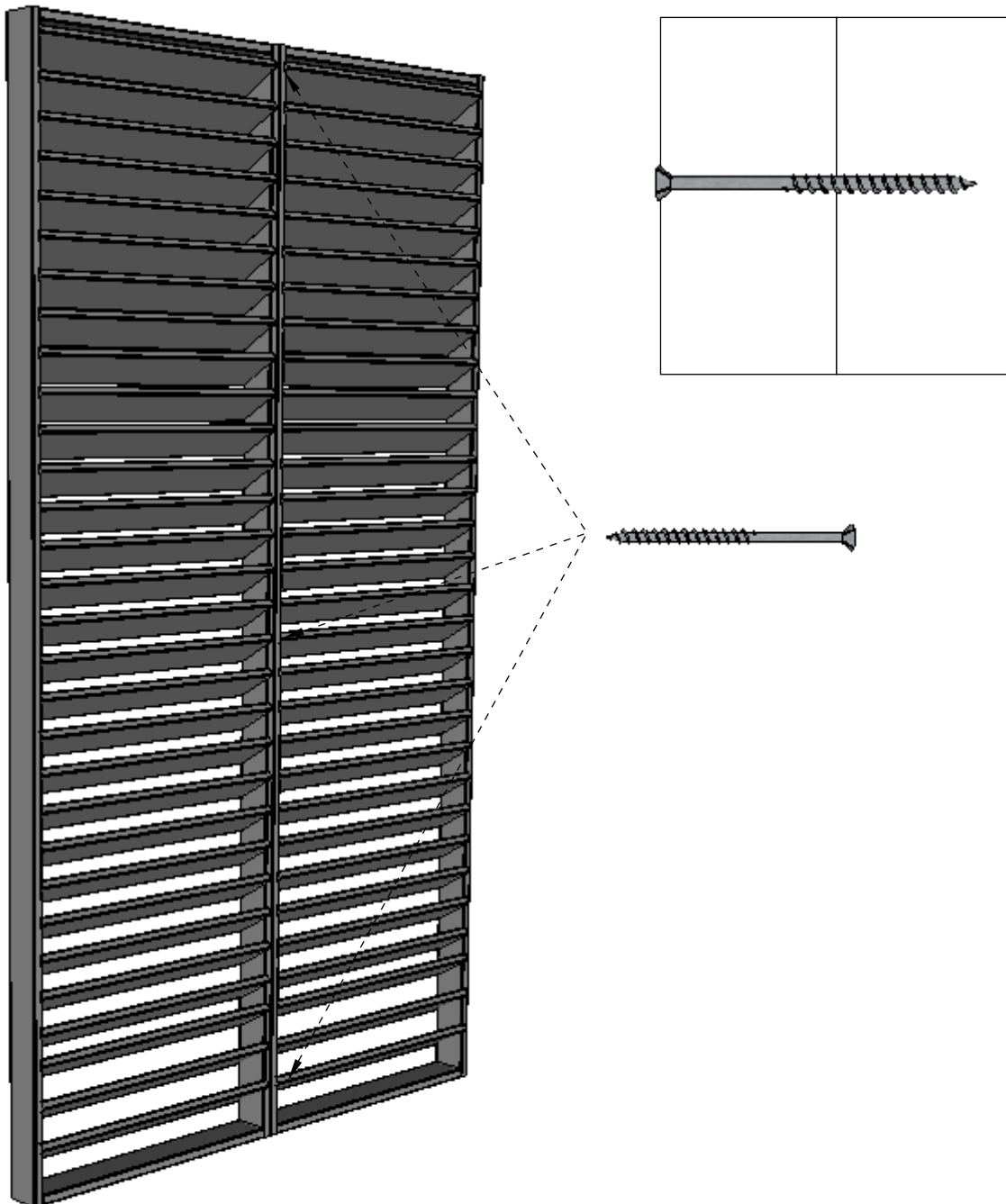

19



Plan: 17 Zalusii  
Positions:

QNU35x35x130Zn

 QKRYP5X40ZnTX

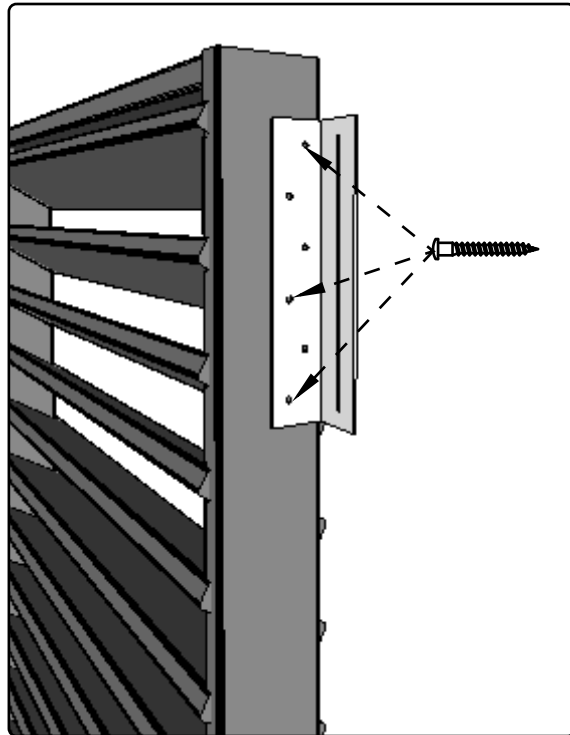
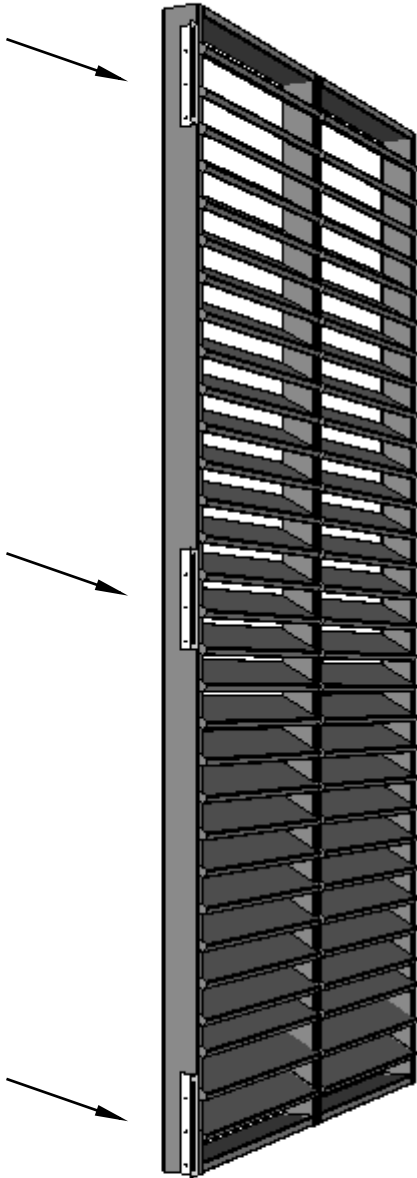
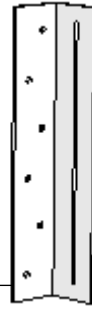

Plan: 17 Zalusii  
Positions:

QNU35x35x130Zn



QKRKK8X30Zn

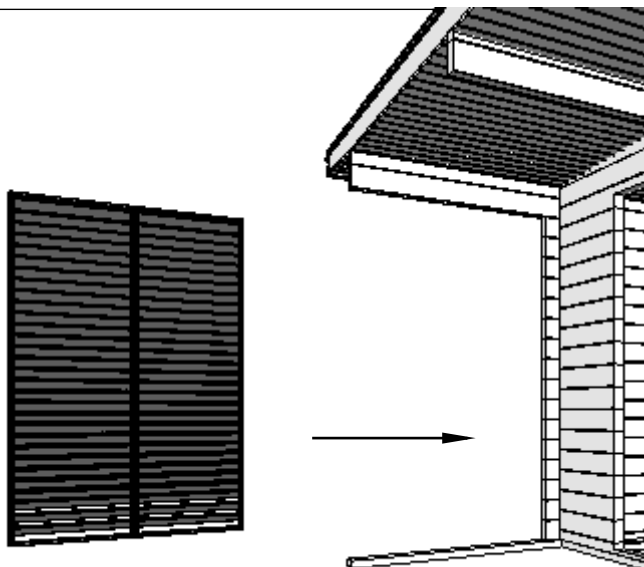
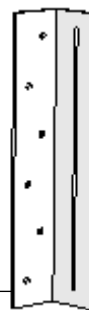

21

Plan: 17 Zalusii

Positions:

 QKRYP5X40ZnTX

 QKRKK8X30Zn

 QKRPP3\_5X70Zn

QNU50x60x130Zn

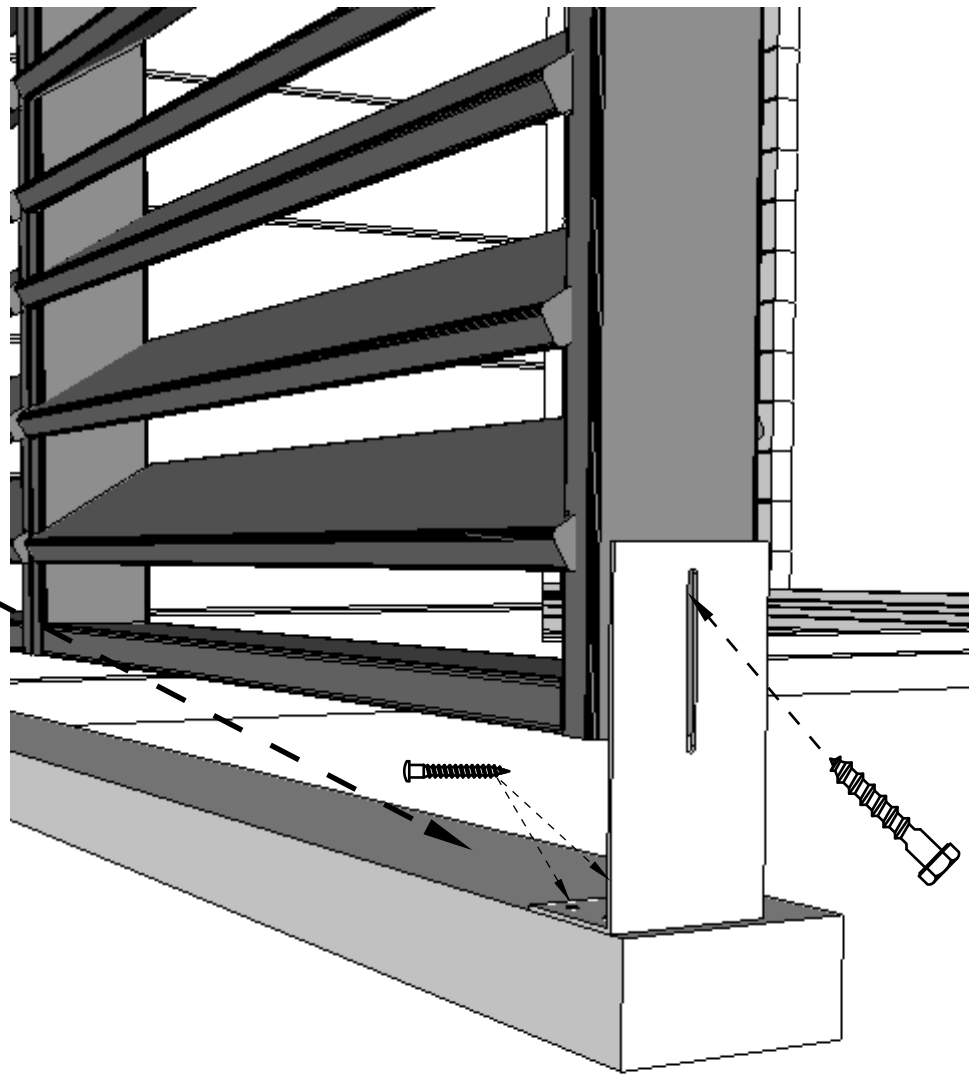
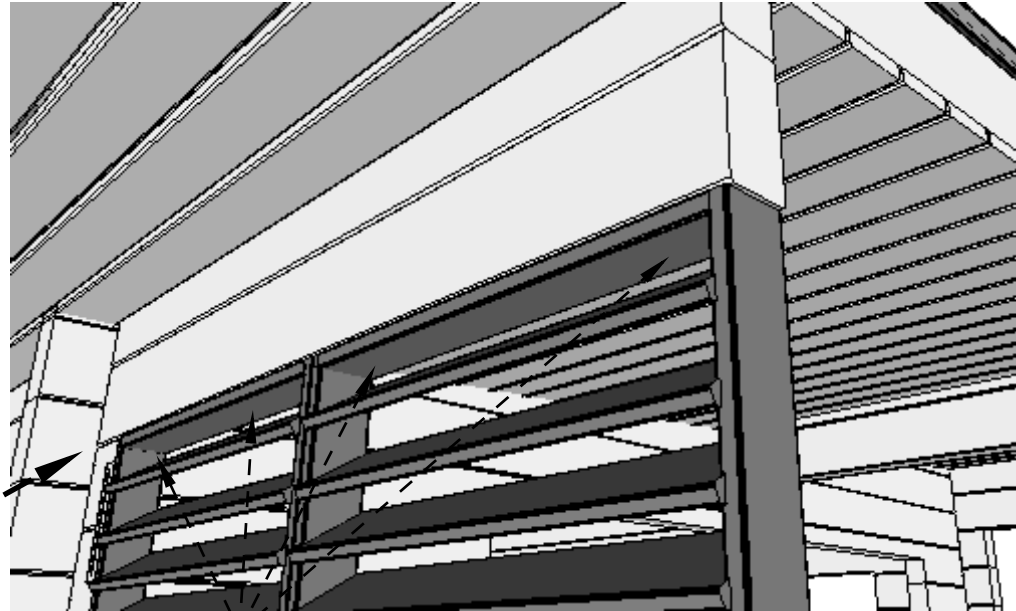
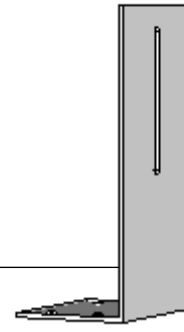

Plan: 15 LU59-5P-7016

Positions:

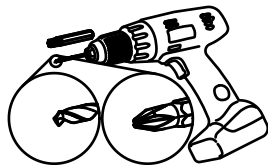
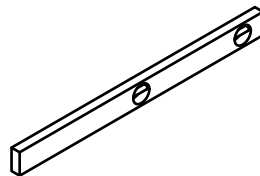
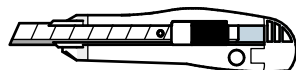
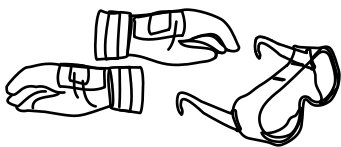

*I*

Plan: 15 LU59-5P-7016

Positions:

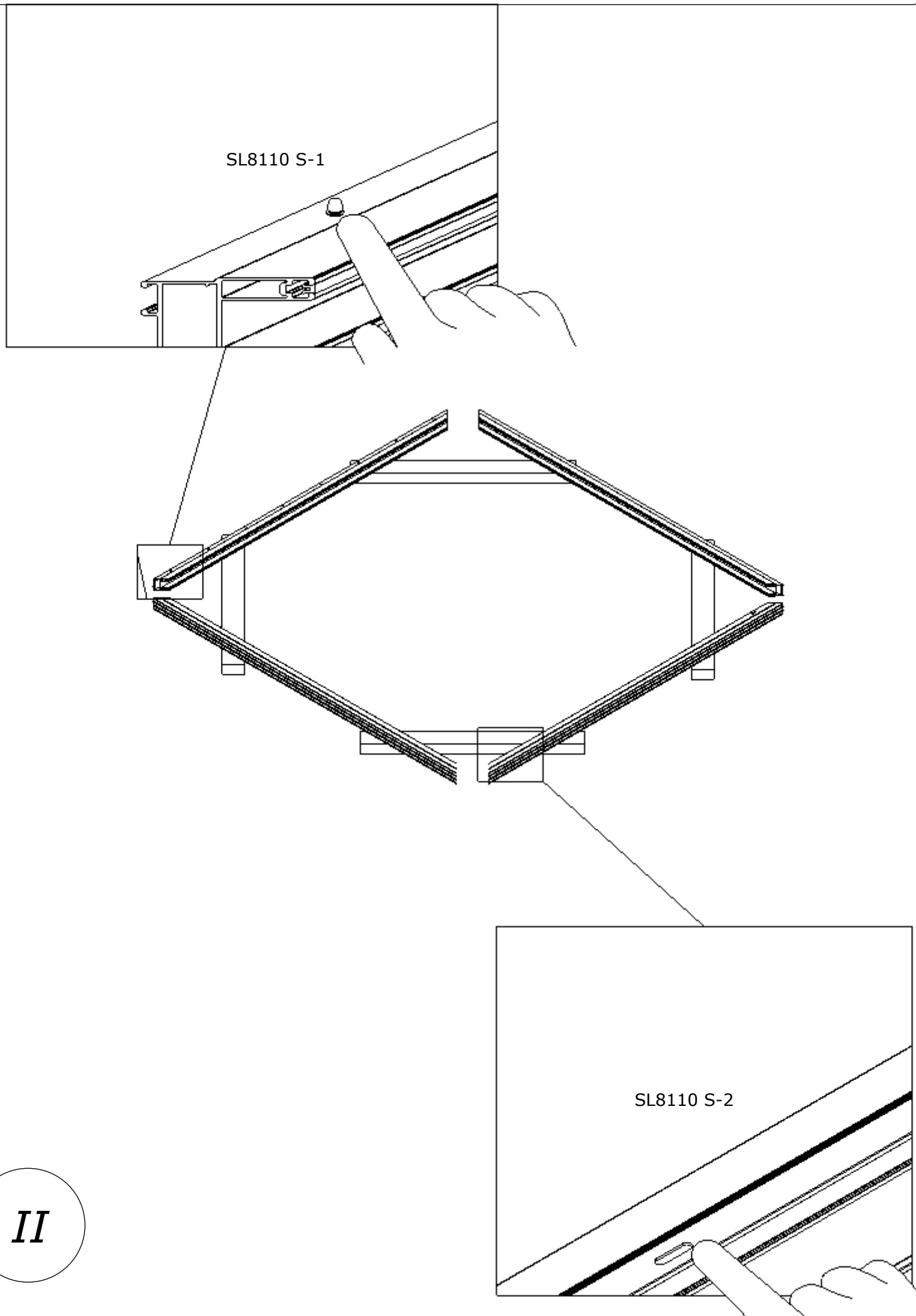

Plan: 15 LU59-5P-7016

Positions:

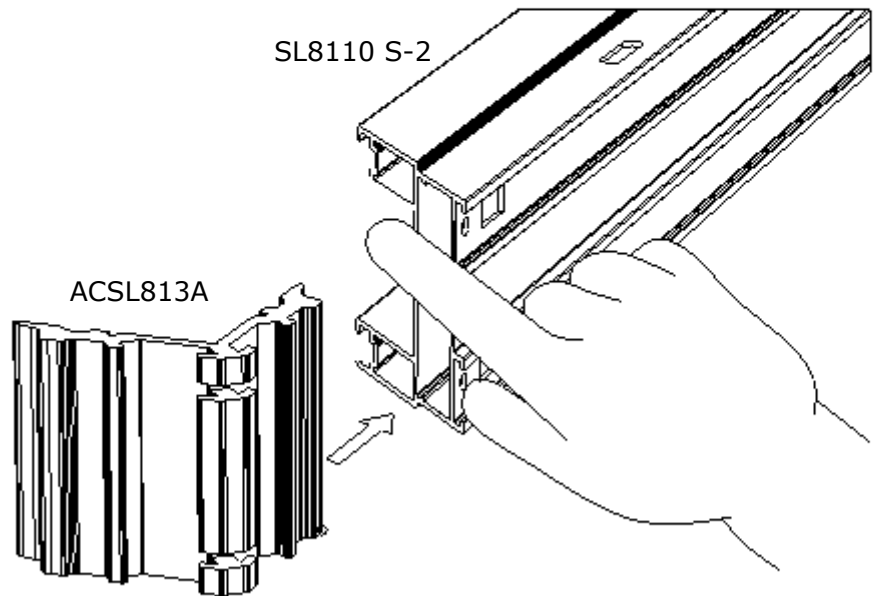
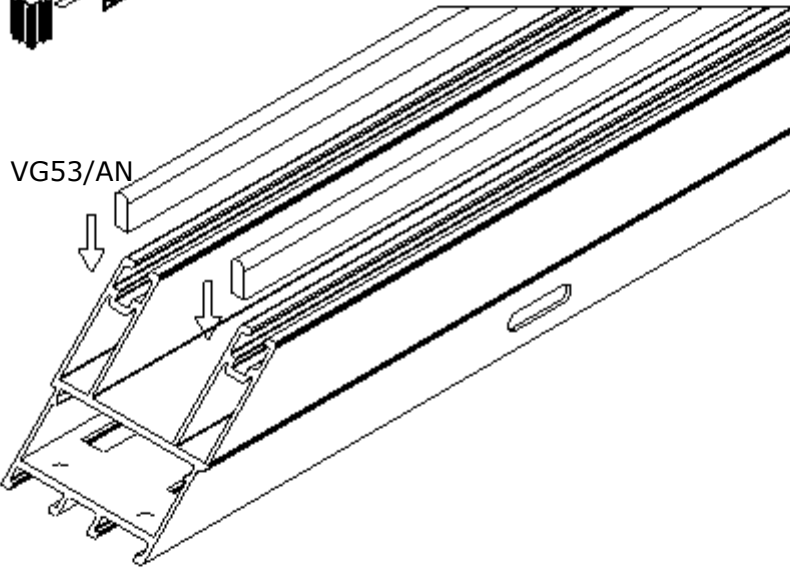
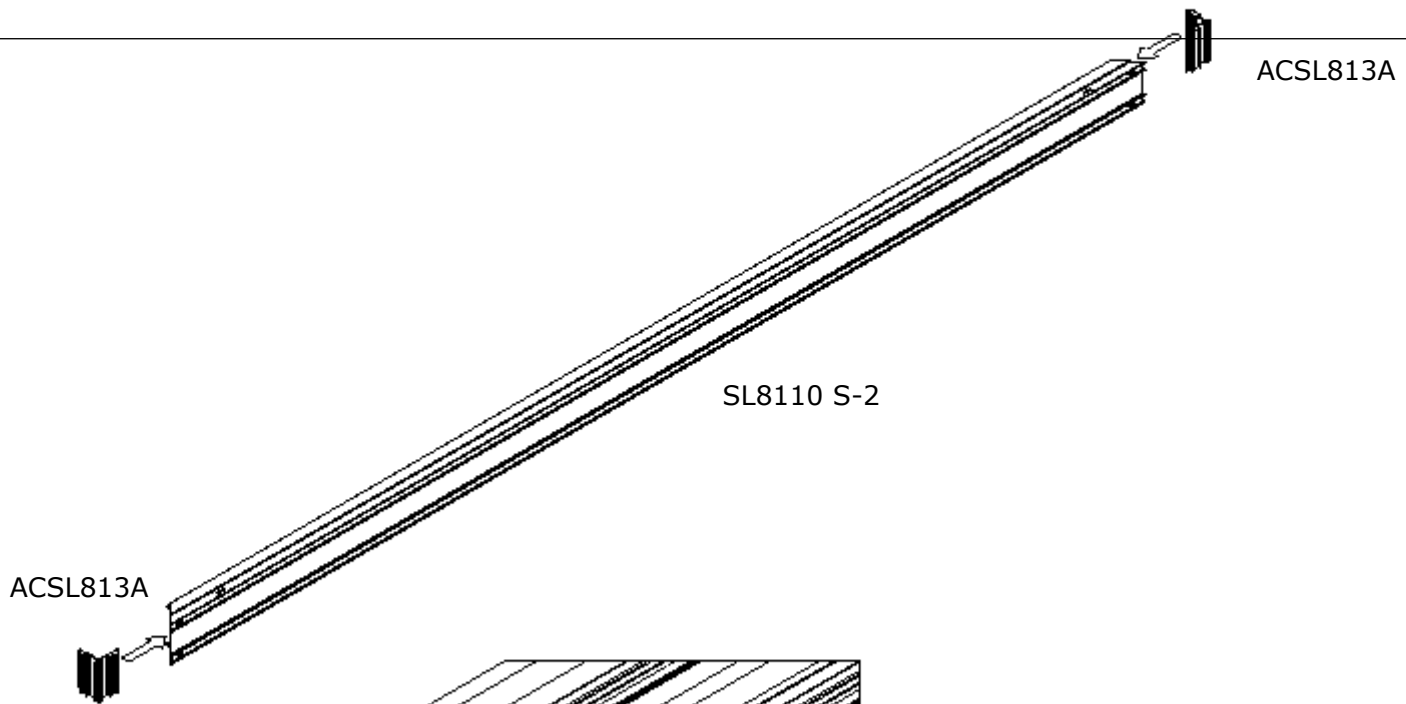

Plan: 15 LU59-5P-7016

Positions:

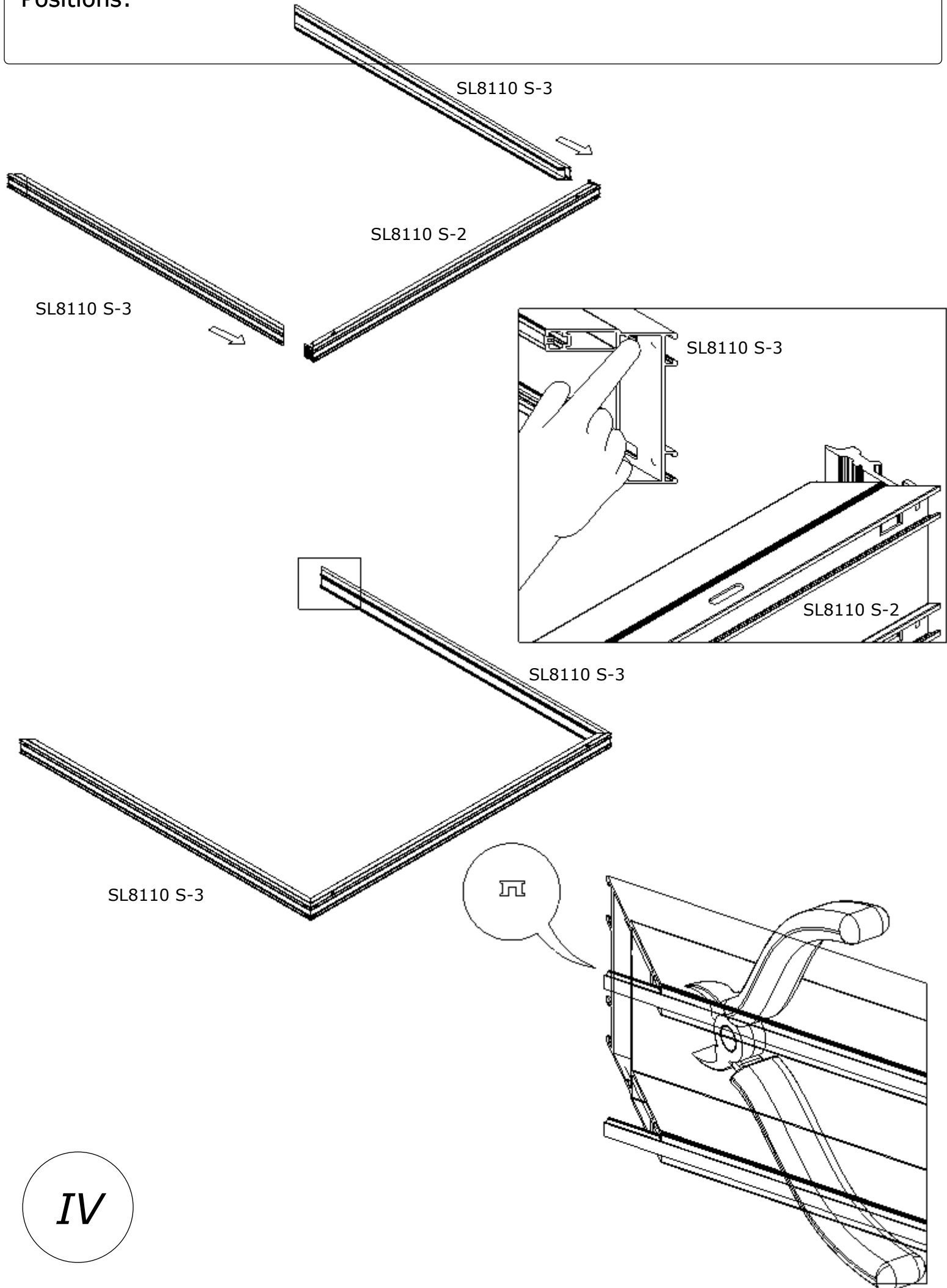

IV

Plan: 15 LU59-5P-7016

Positions:

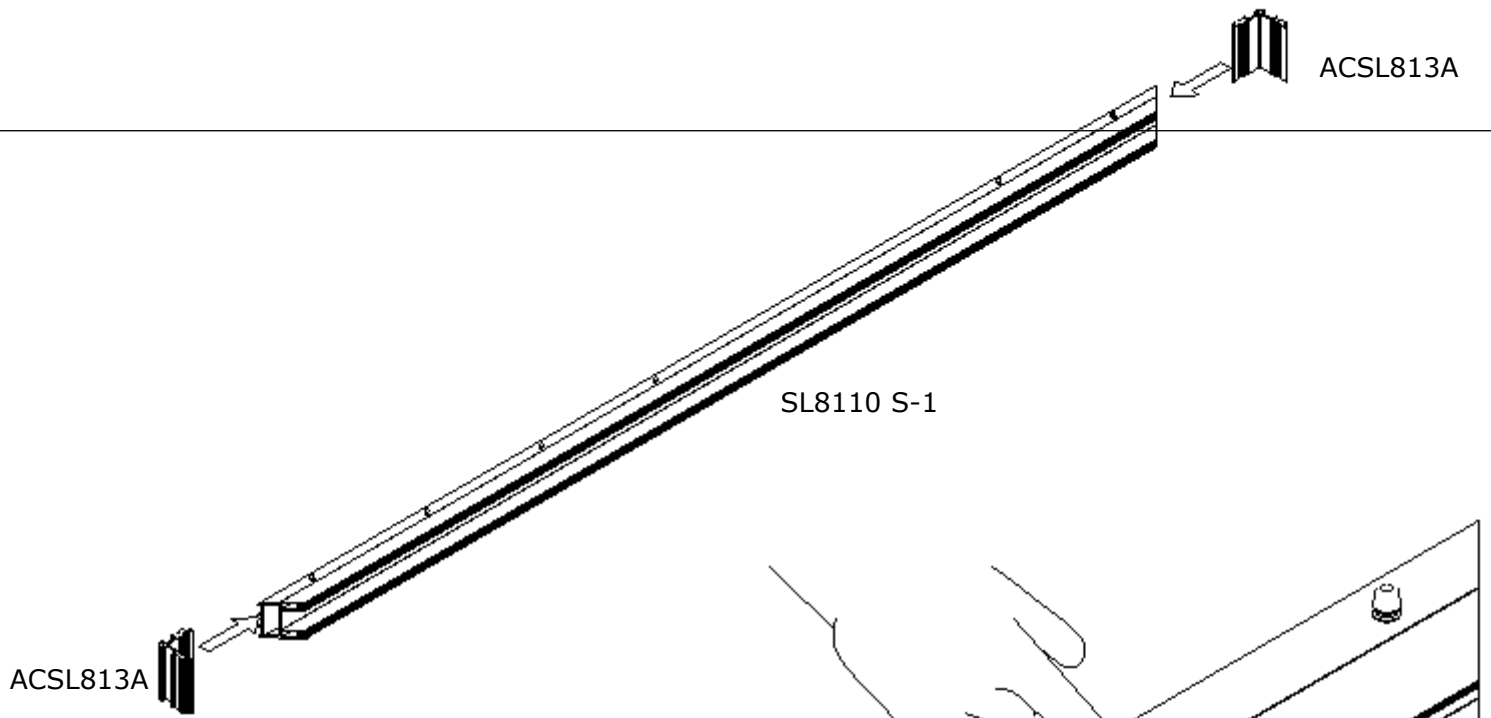

SL8110 S-1

ACSL813A

ACSL813A

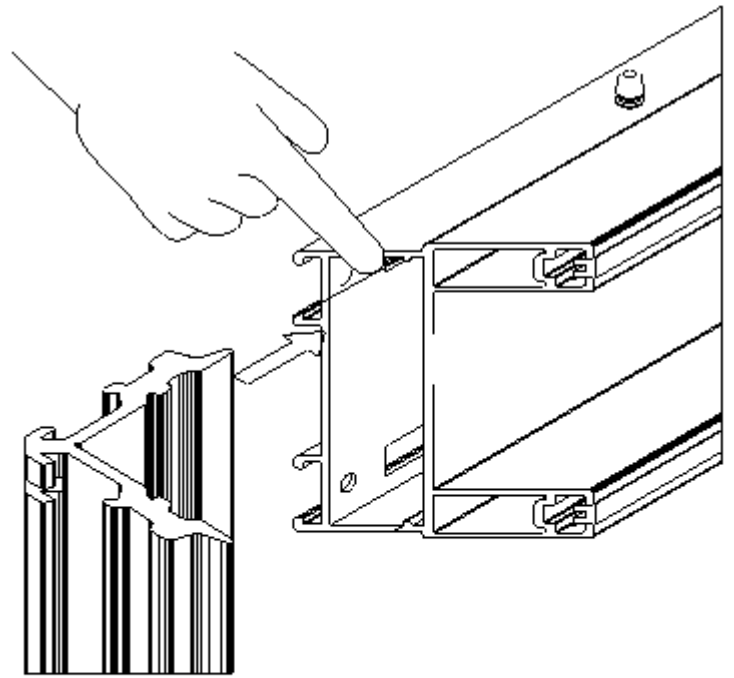

ACSL813A

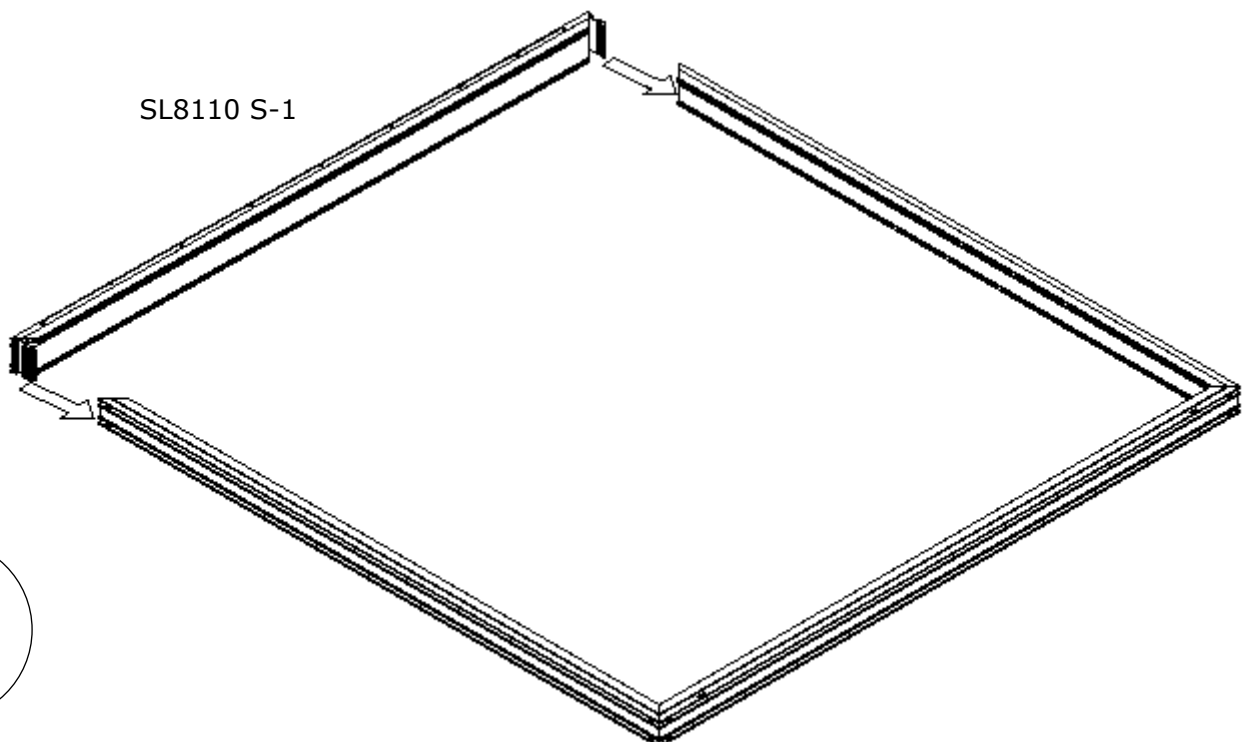

SL8110 S-1

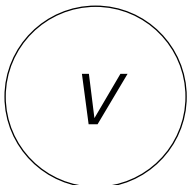



Plan: 15 LU59-5P-7016

Positions:

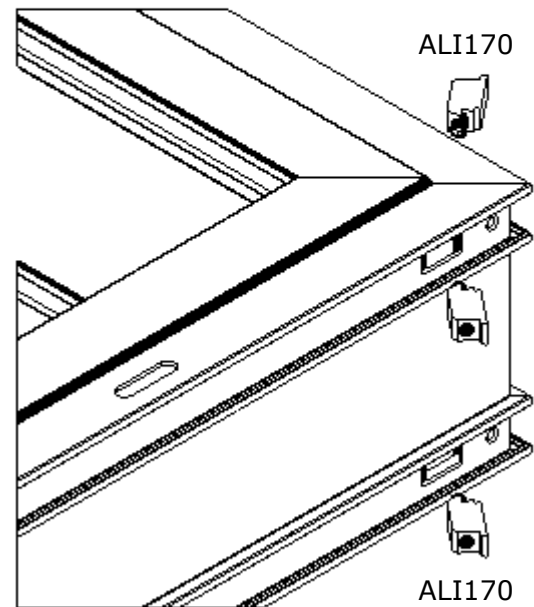
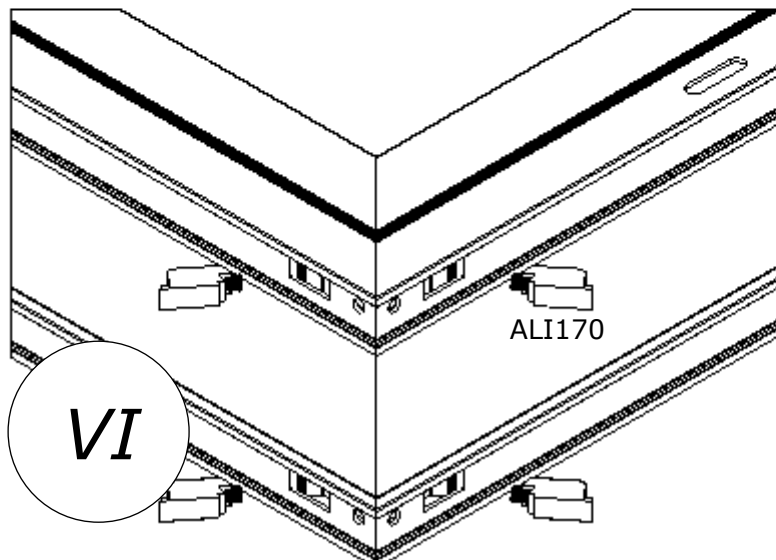
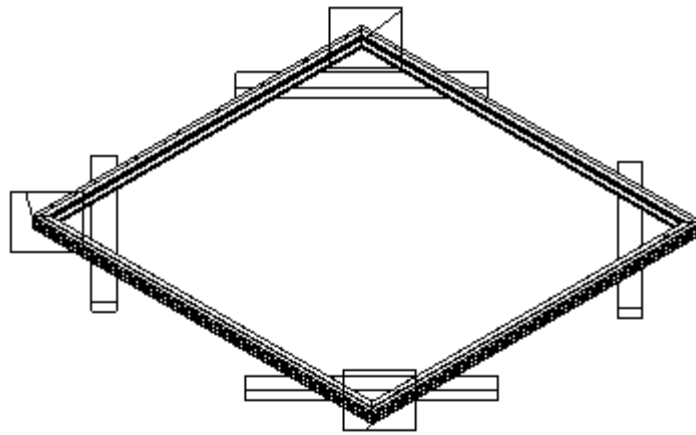
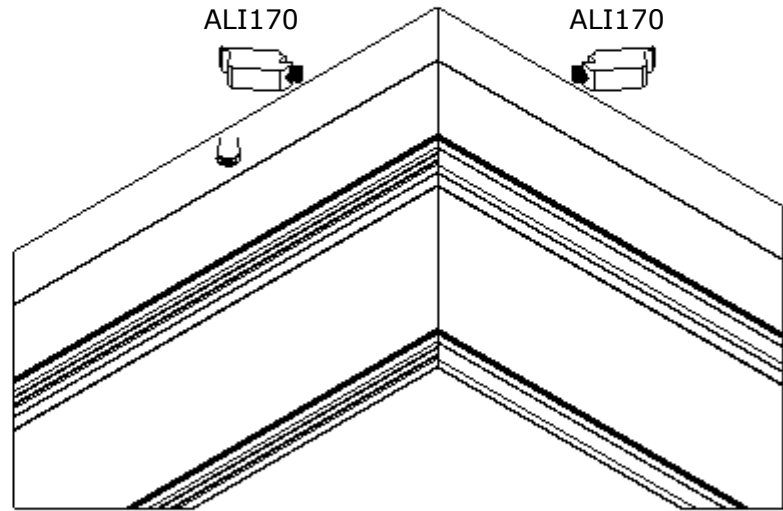
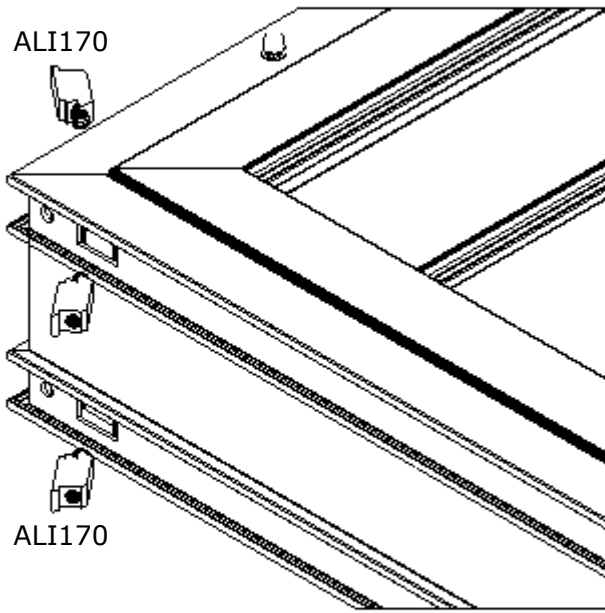

Plan: 15 LU59-5P-7016

Positions:

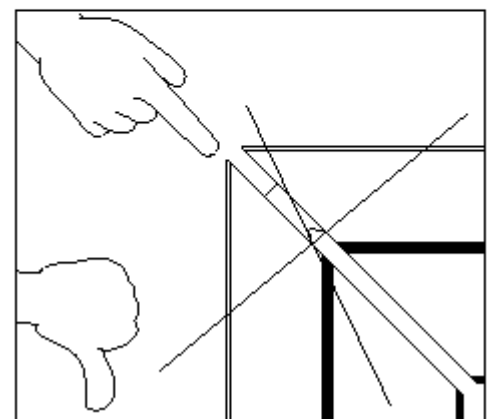
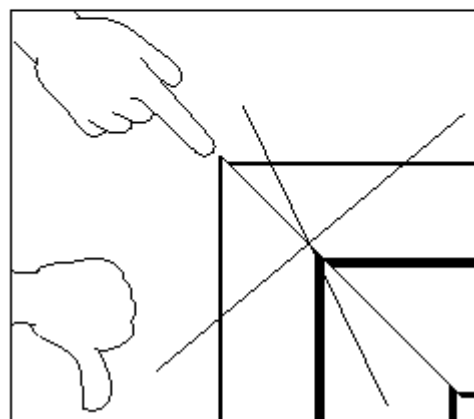
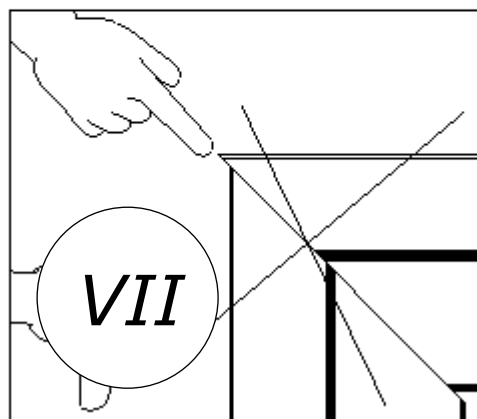
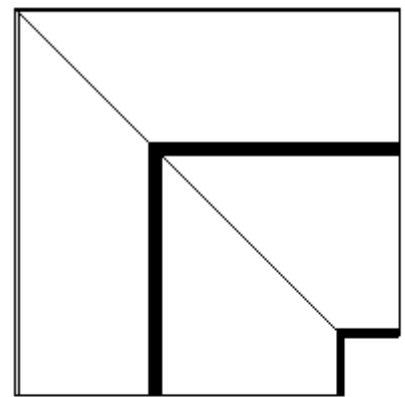
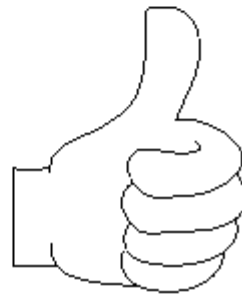
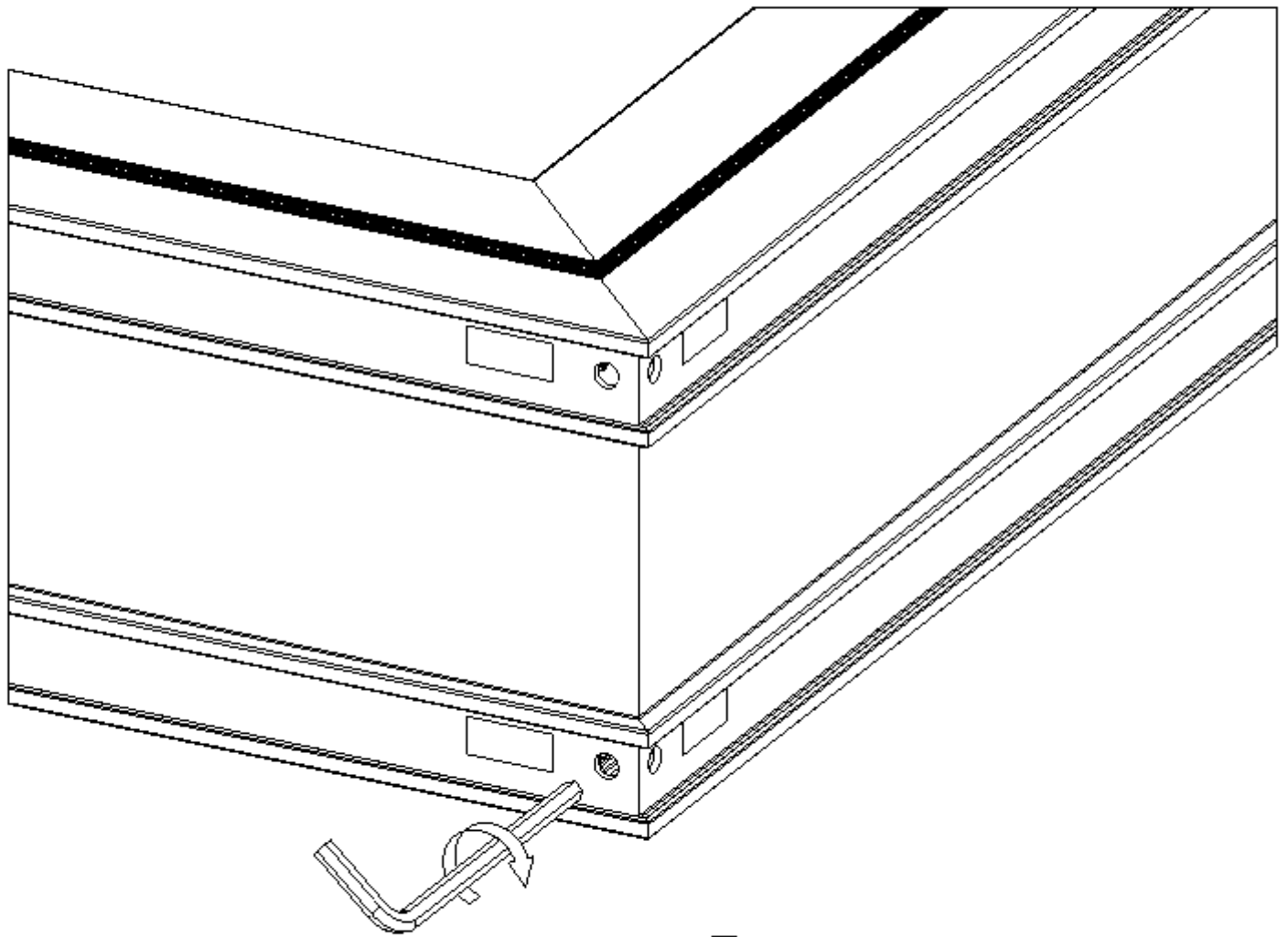

Plan:

Positions: TP, Sis



QKRPP3-5x50Zn

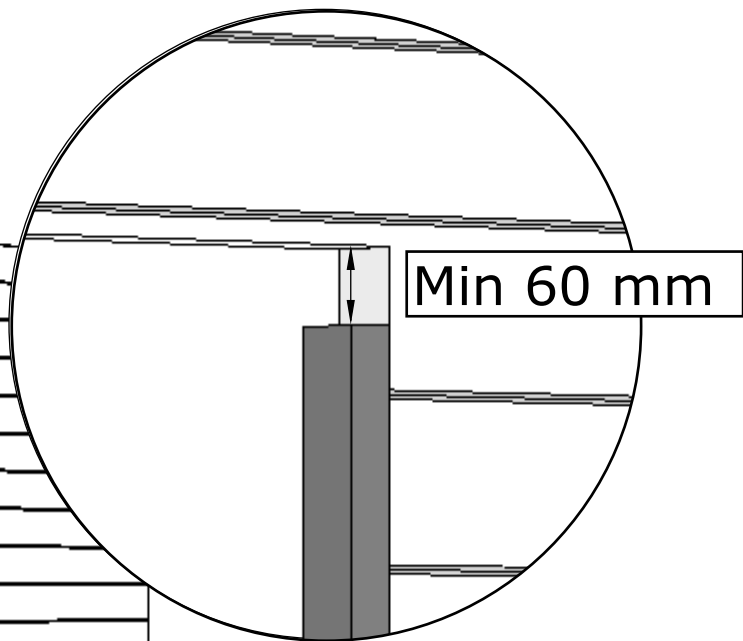
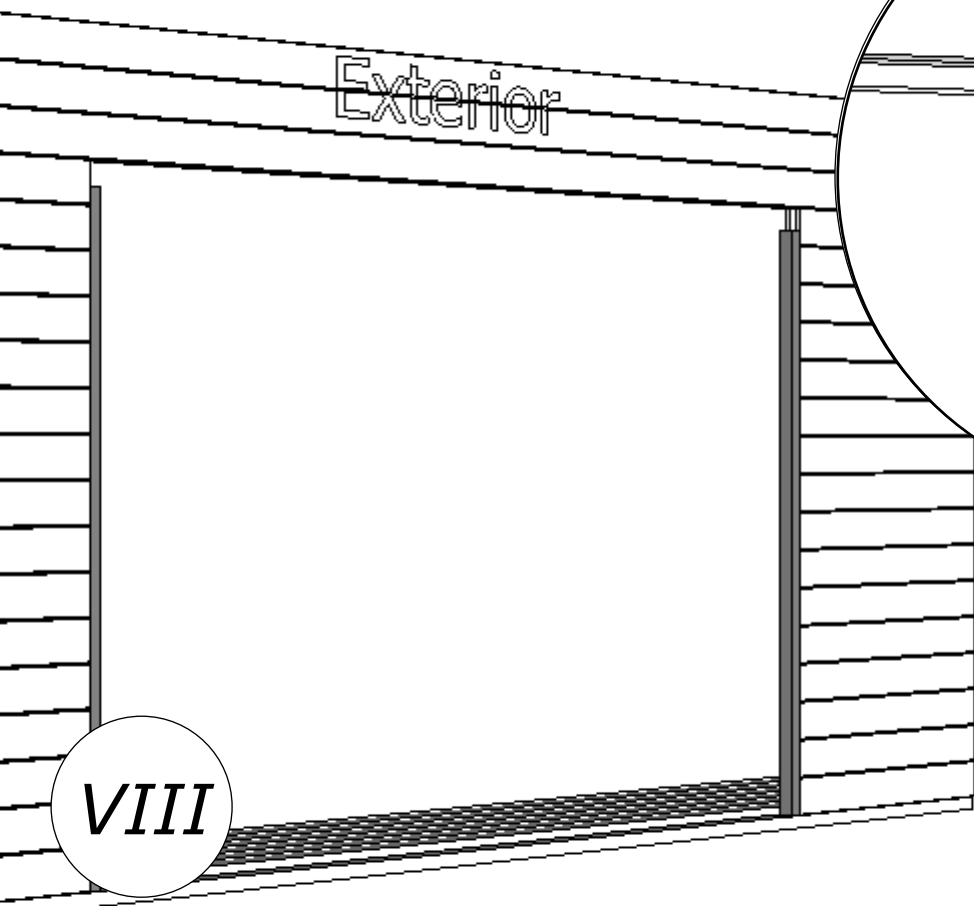
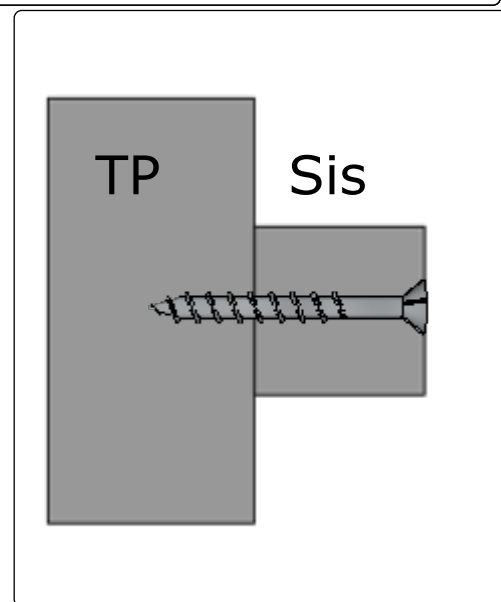
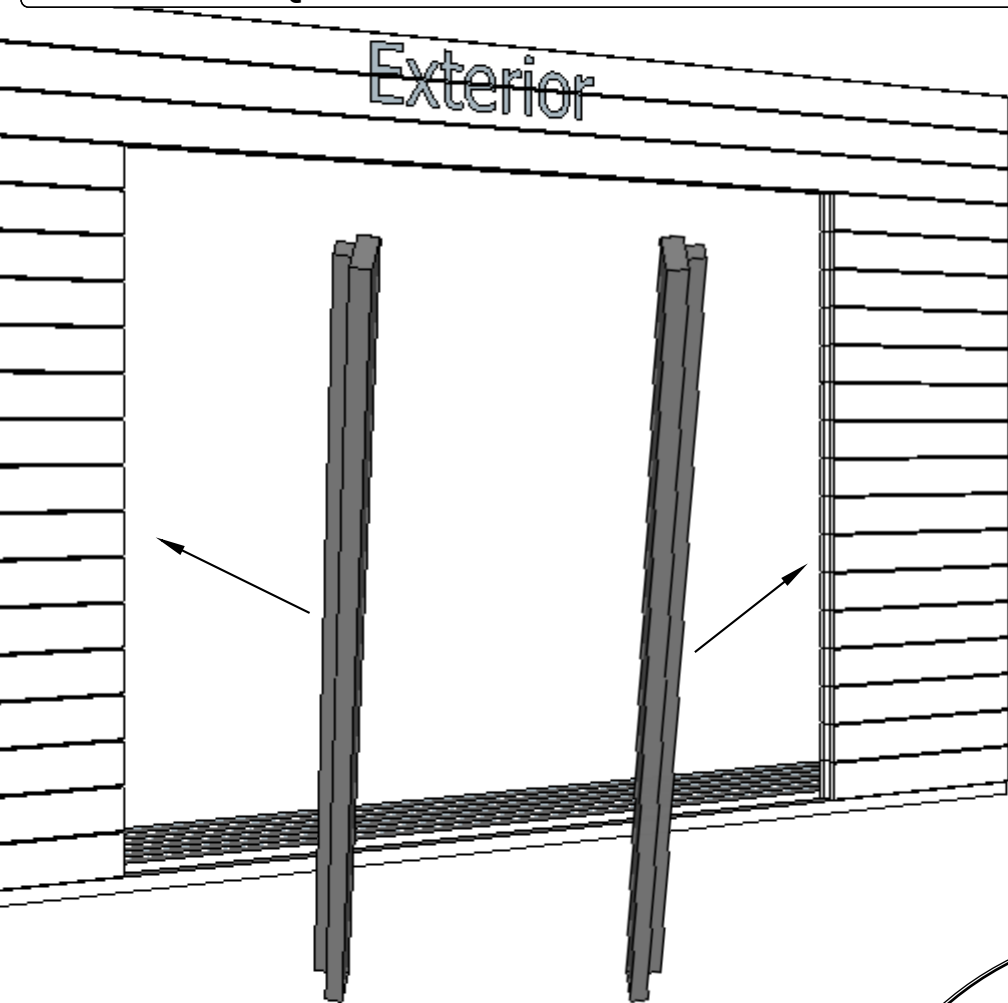

VIII

Plan: 15 LU59-5P-7016

Positions: Sla



QKRPP3-5x50Zn

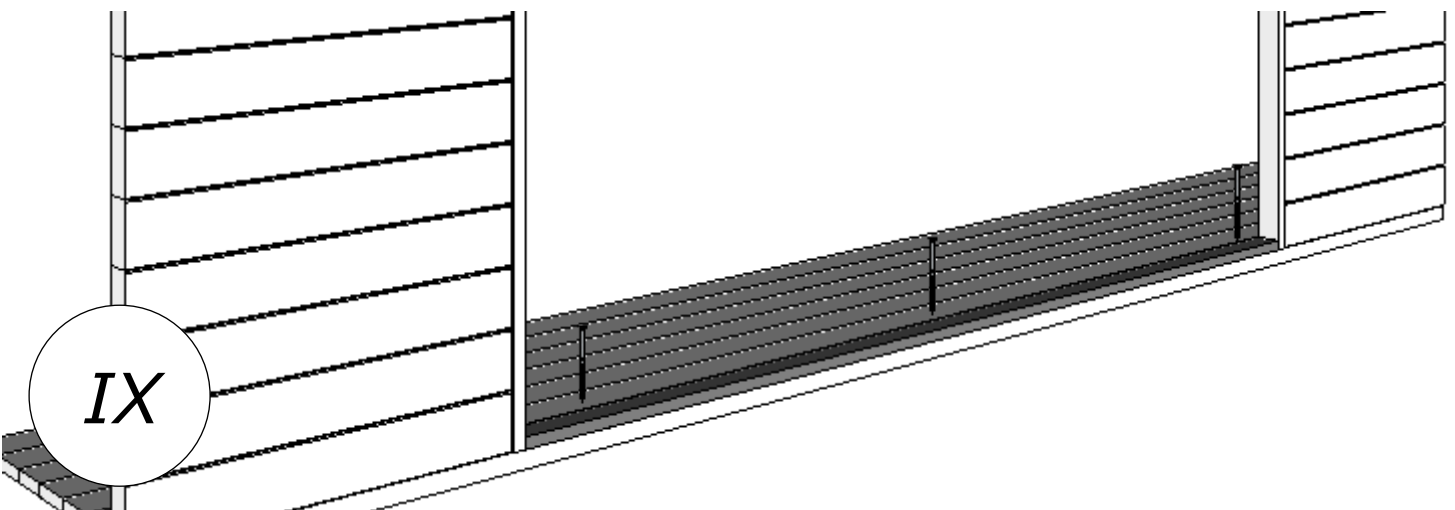
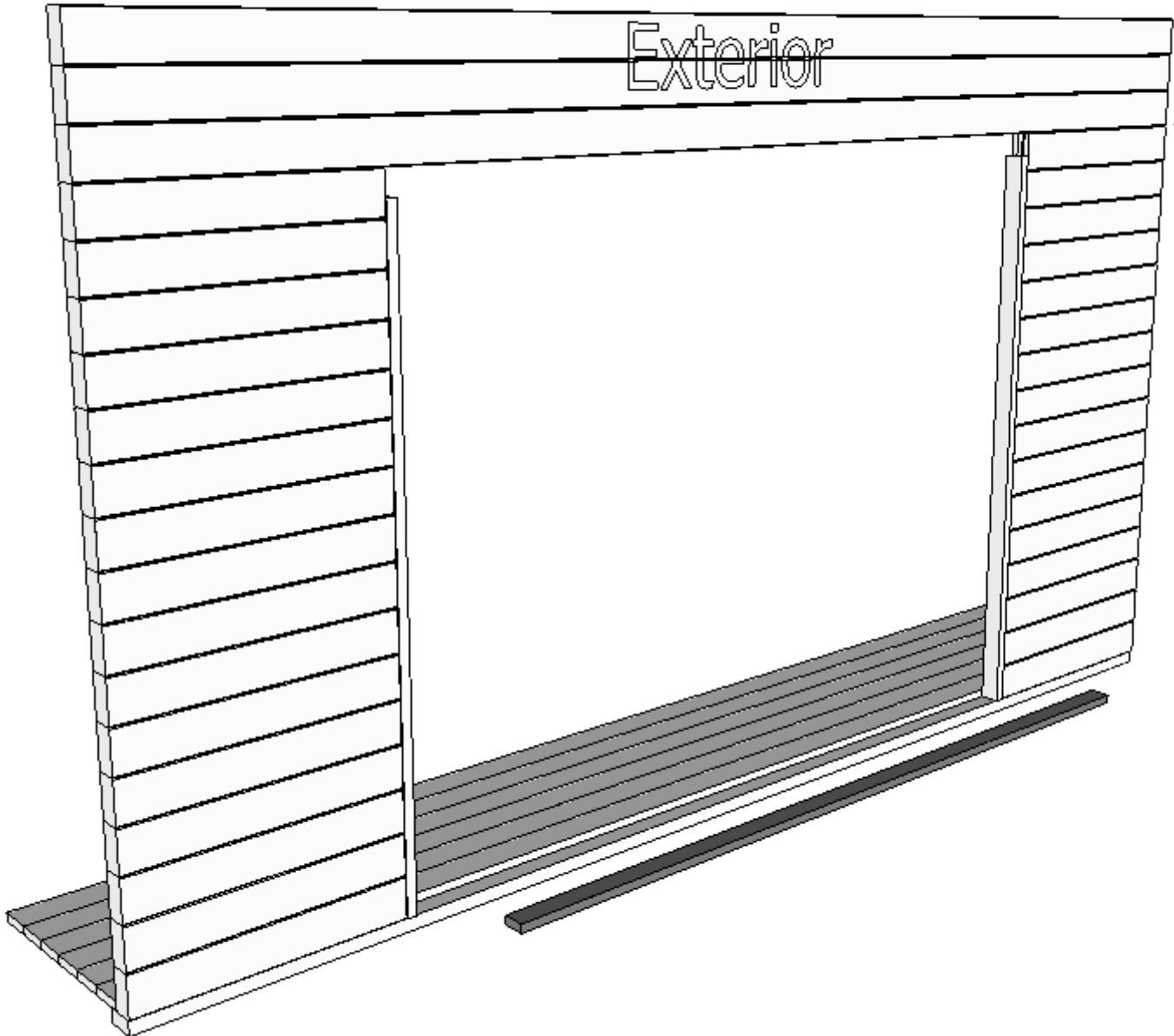

Plan: 15 LU59-5P-7016  
Positions: QP40x30x2010MU

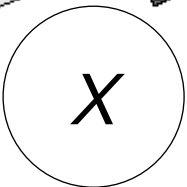
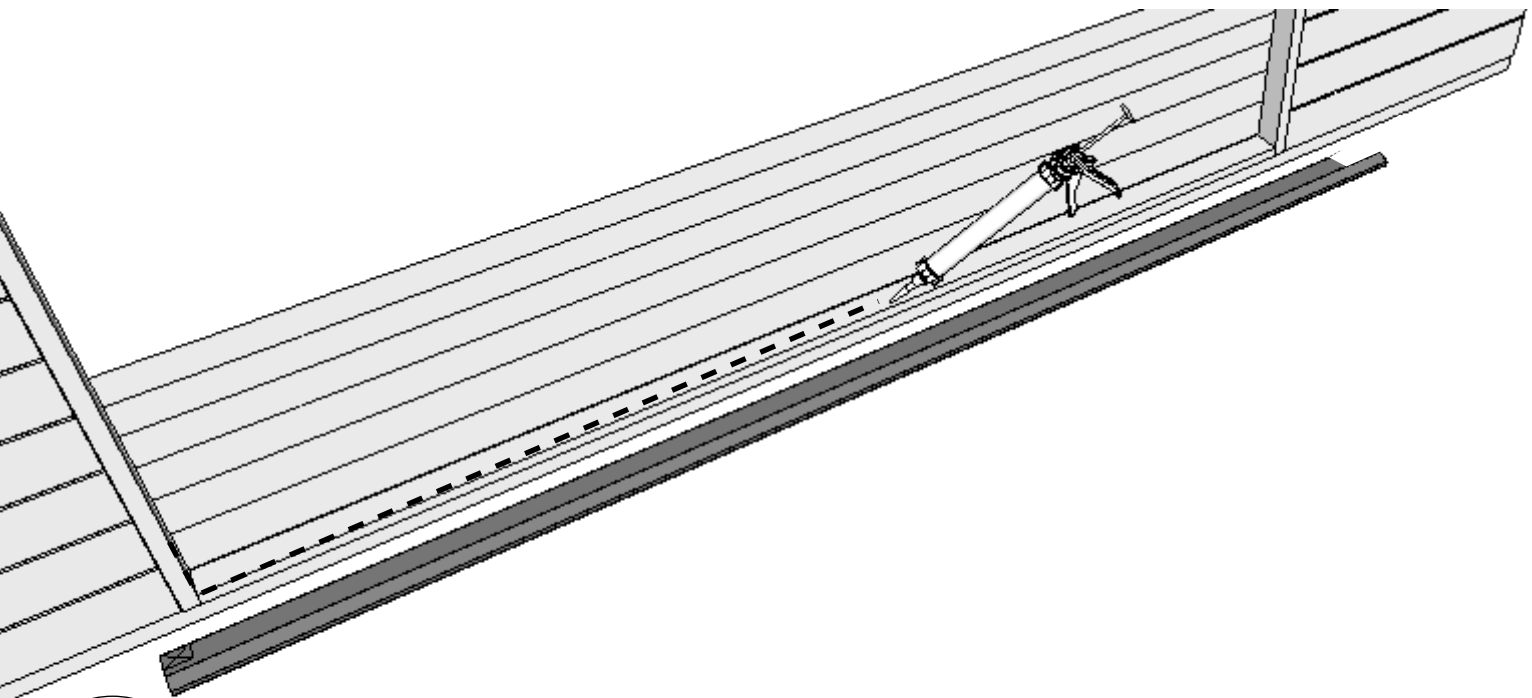
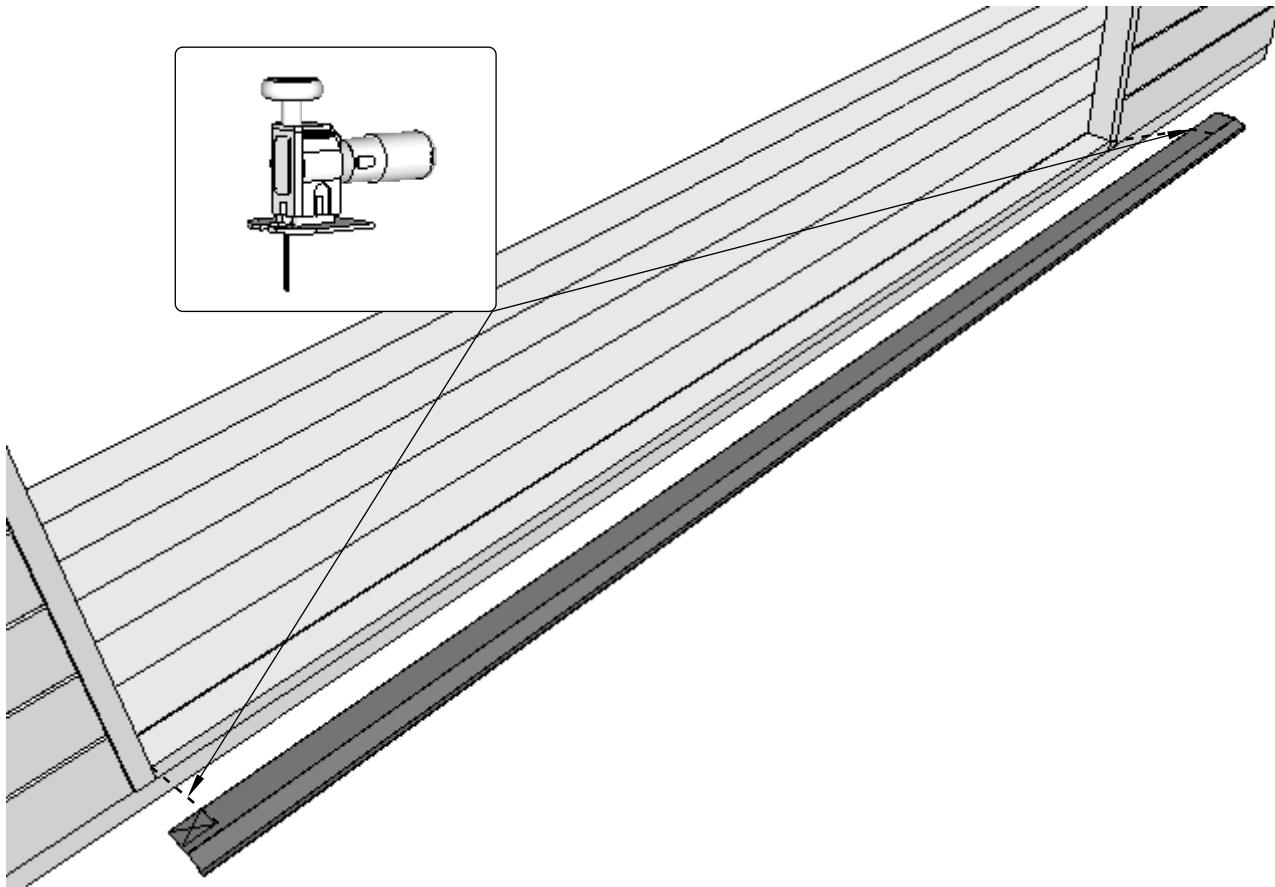
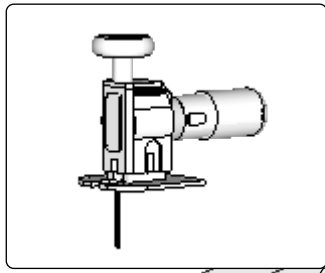

Plan: 15 LU59-5P-7016

Positions:

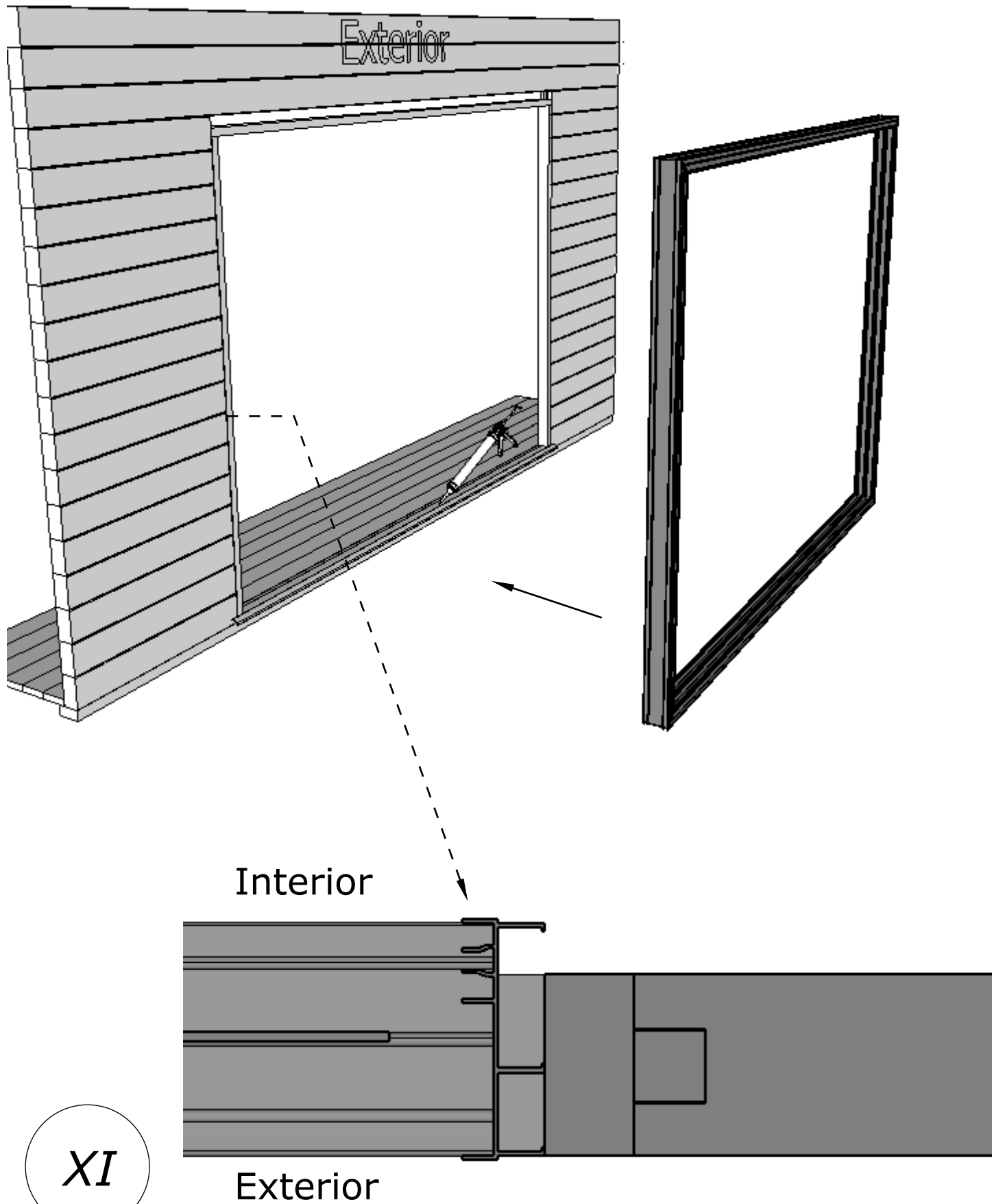

Plan: 15 LU59-5P-7016

Positions:

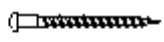

QKRYP5x60Zn

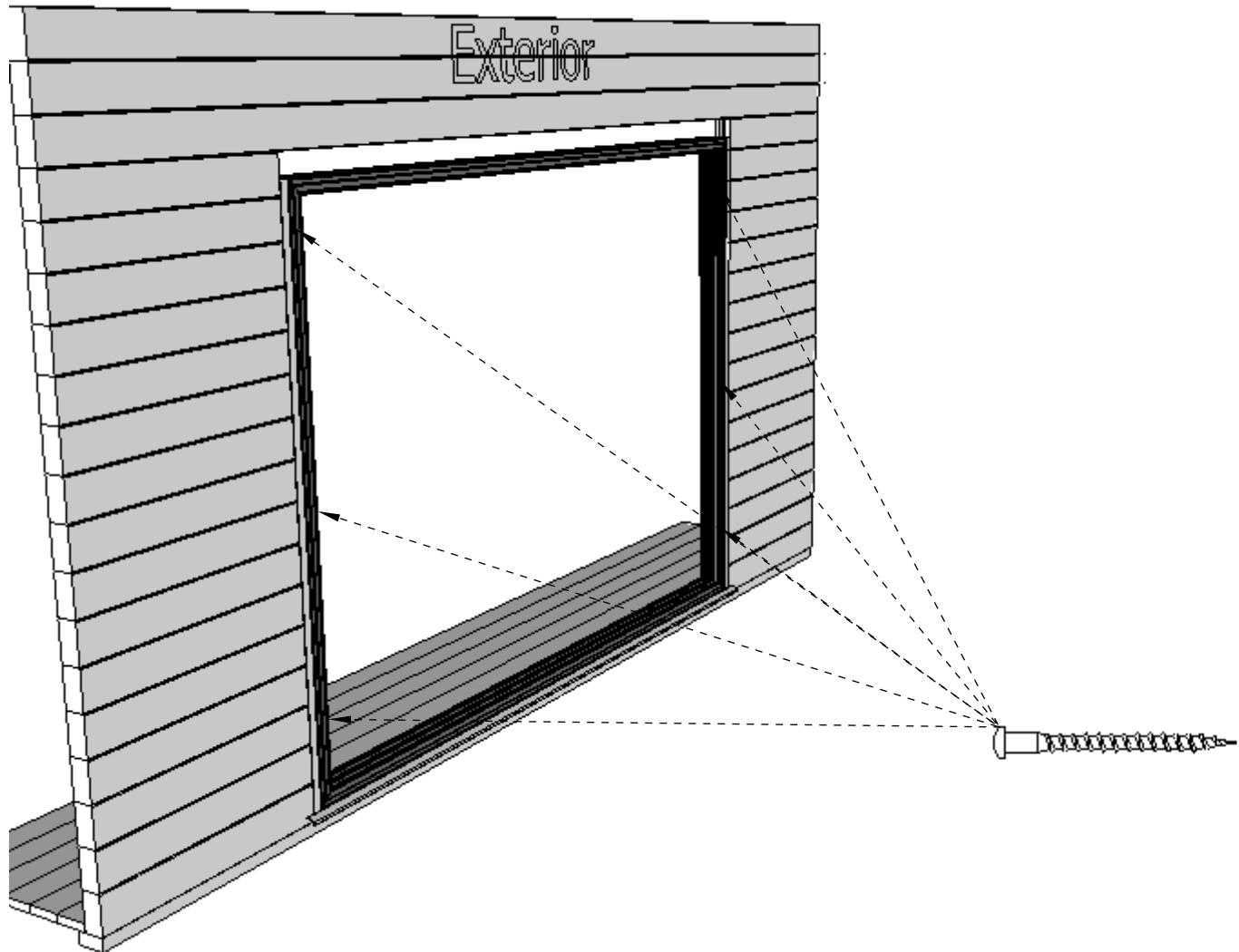

Interior

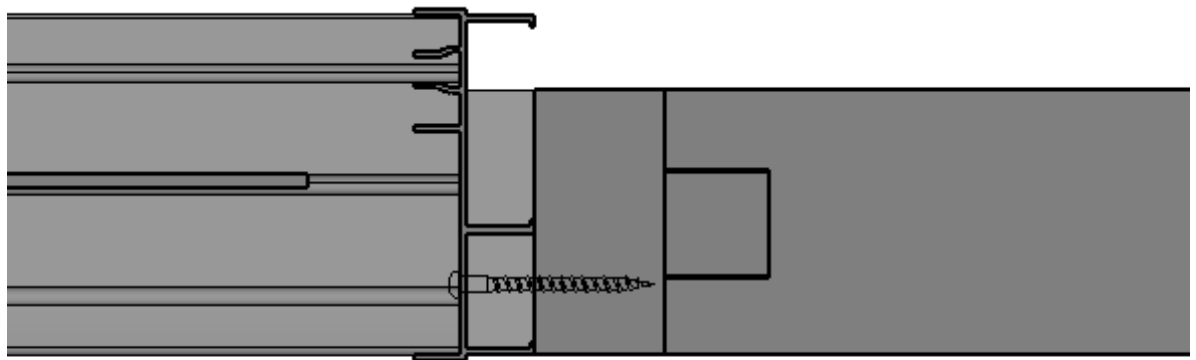

Exterior

*XII*

Plan: 15 LU59-5P-7016

Positions:

Sis



QKRYP5x60Zn

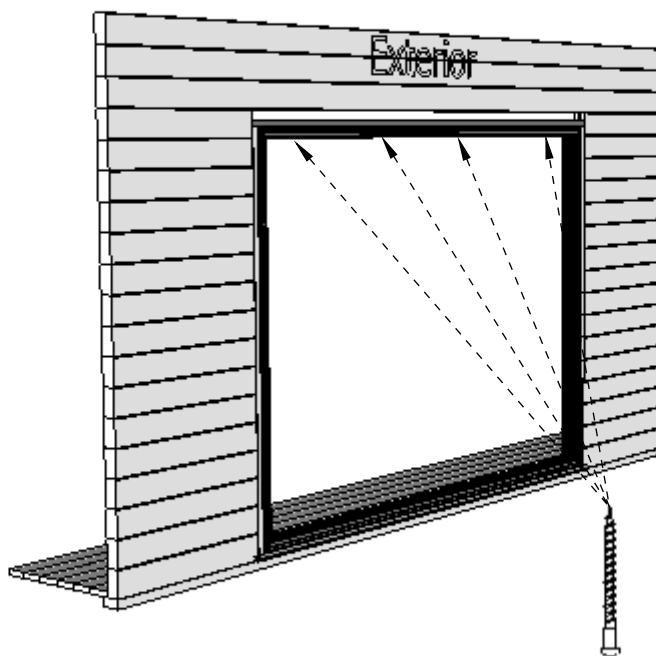
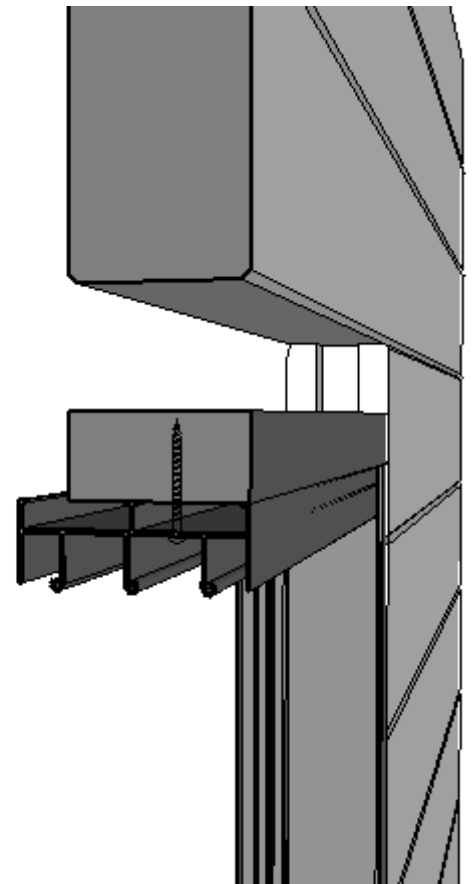
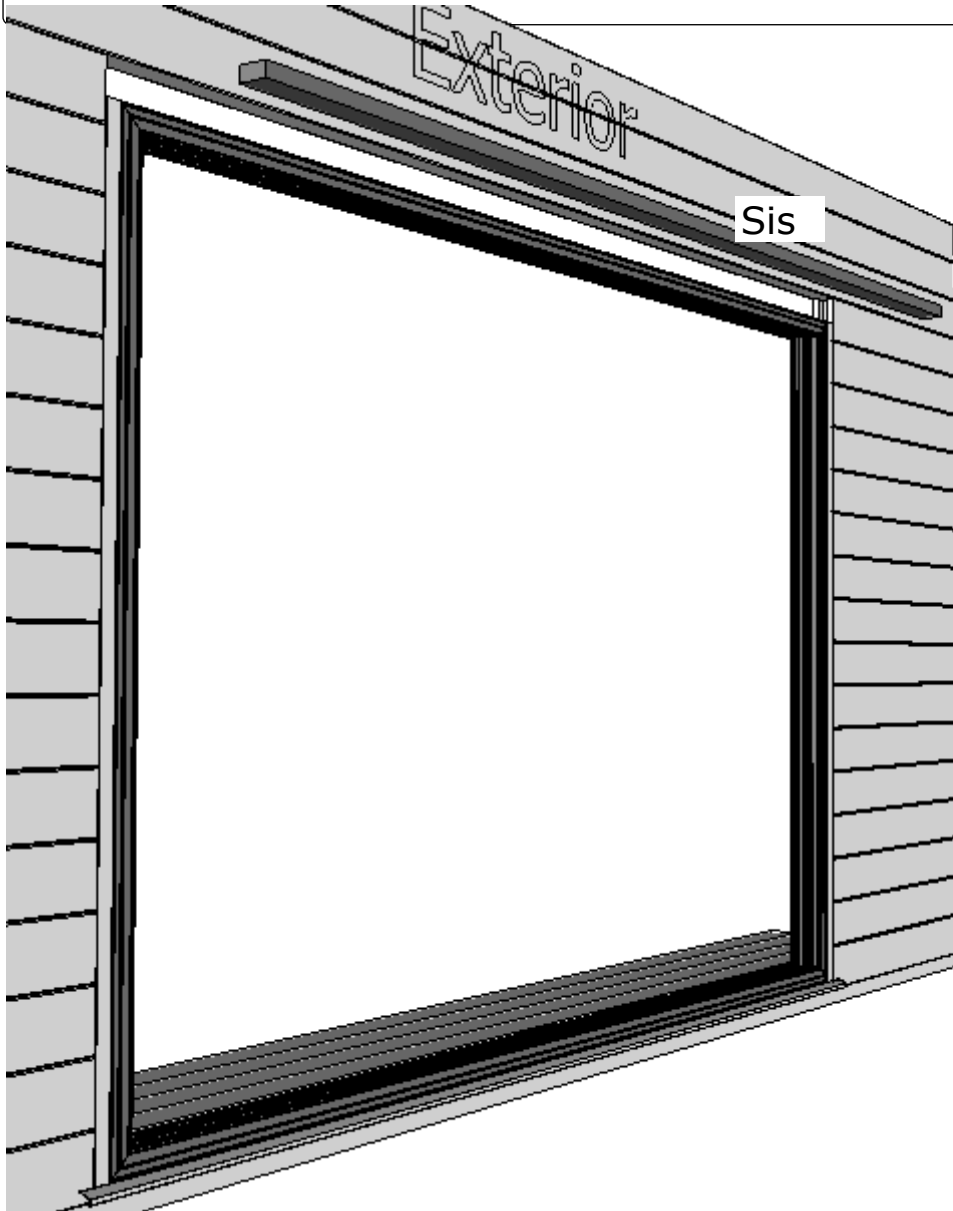



Plan: 15 LU59-5P-7016

Positions:

 QKRYP5x60Zn



QG2

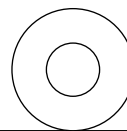

QSE3x8\_5

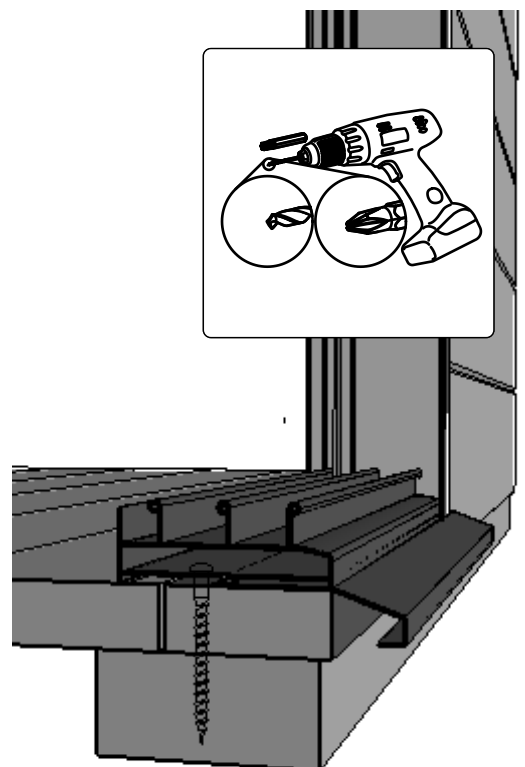
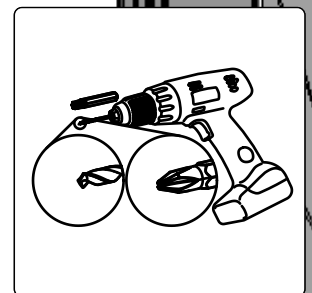
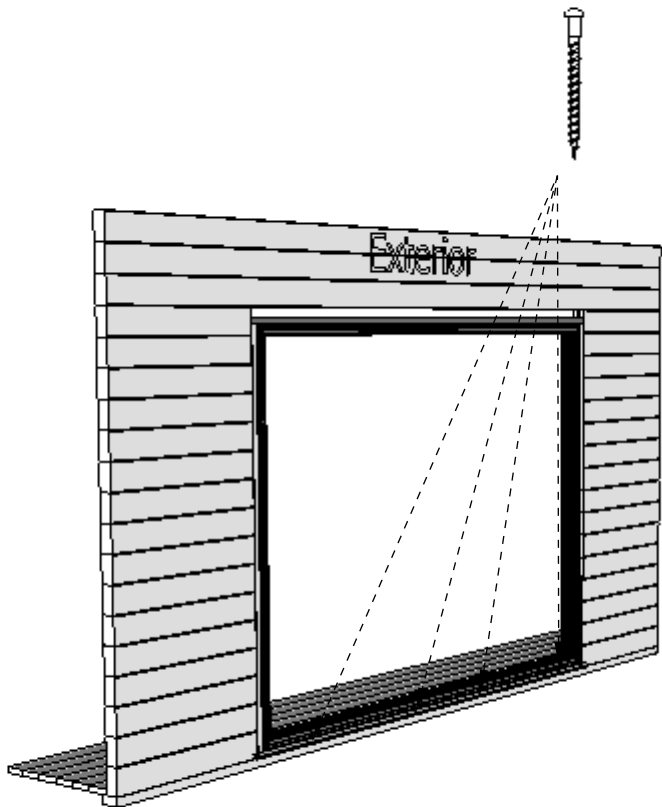

Plan: 15 LU59-5P-7016  
Positions: QT140-1

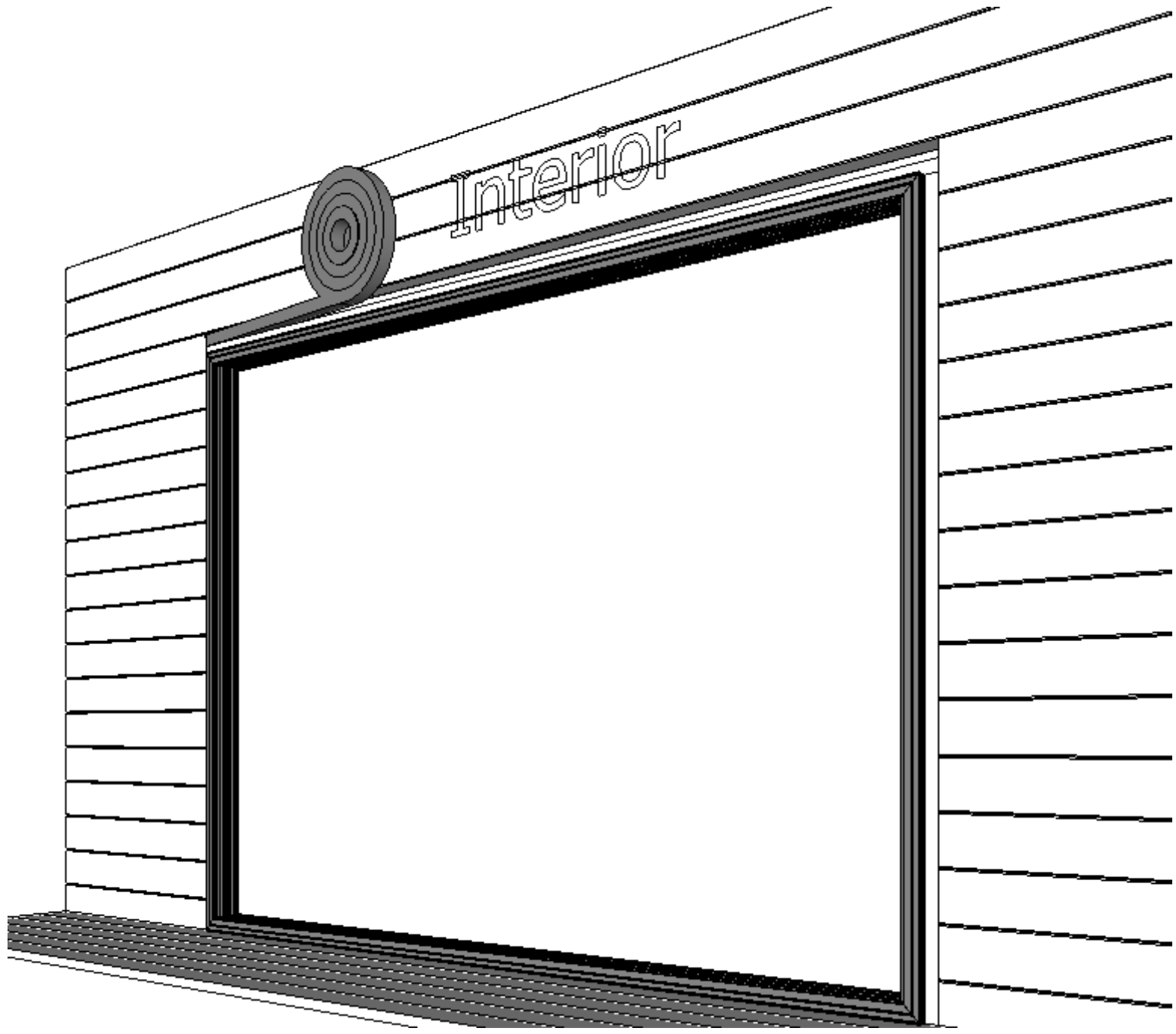

Plan: 15 LU59-5P-7016

Positions: COB



QKRPP3-5x50Zn

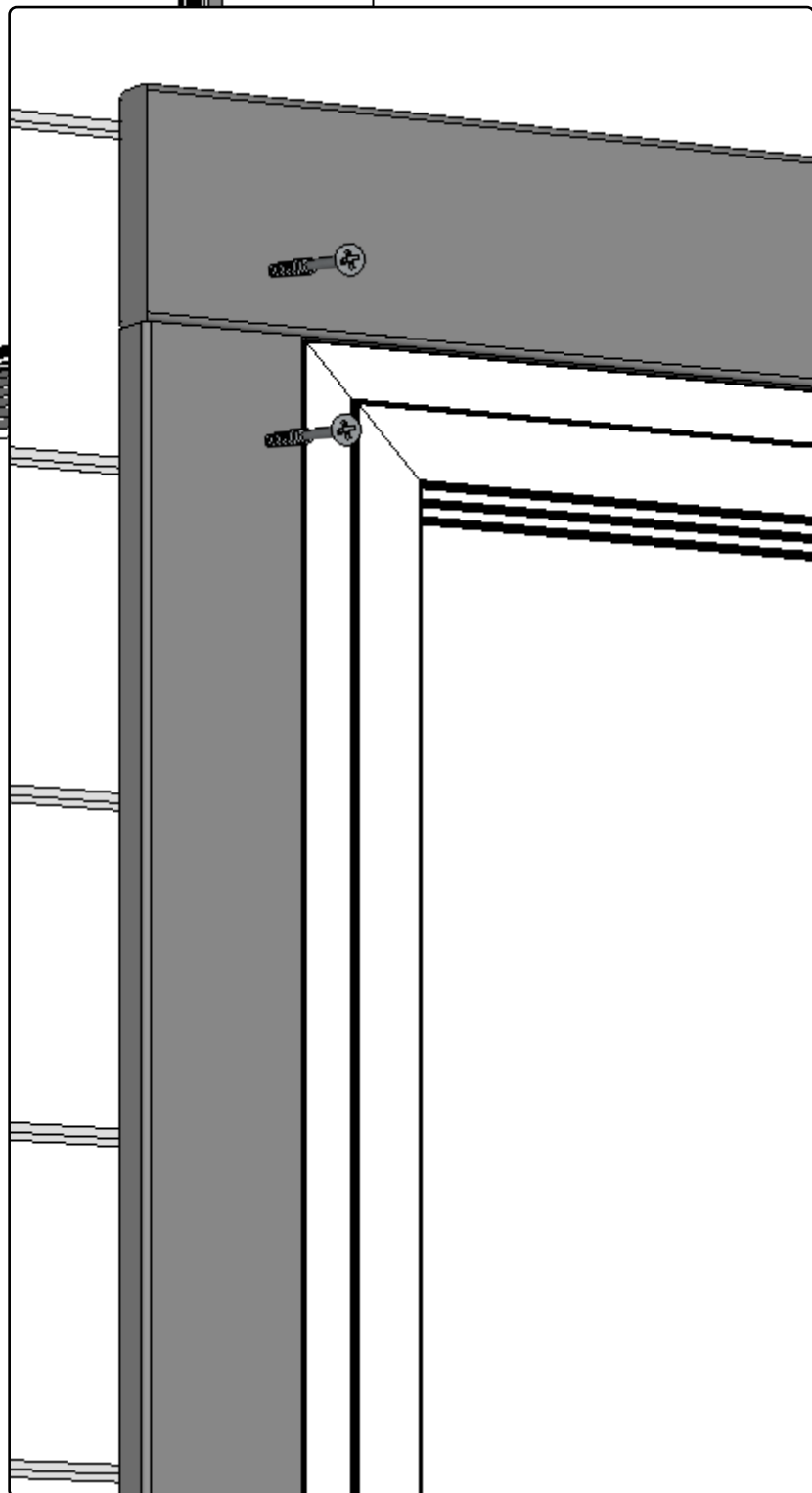
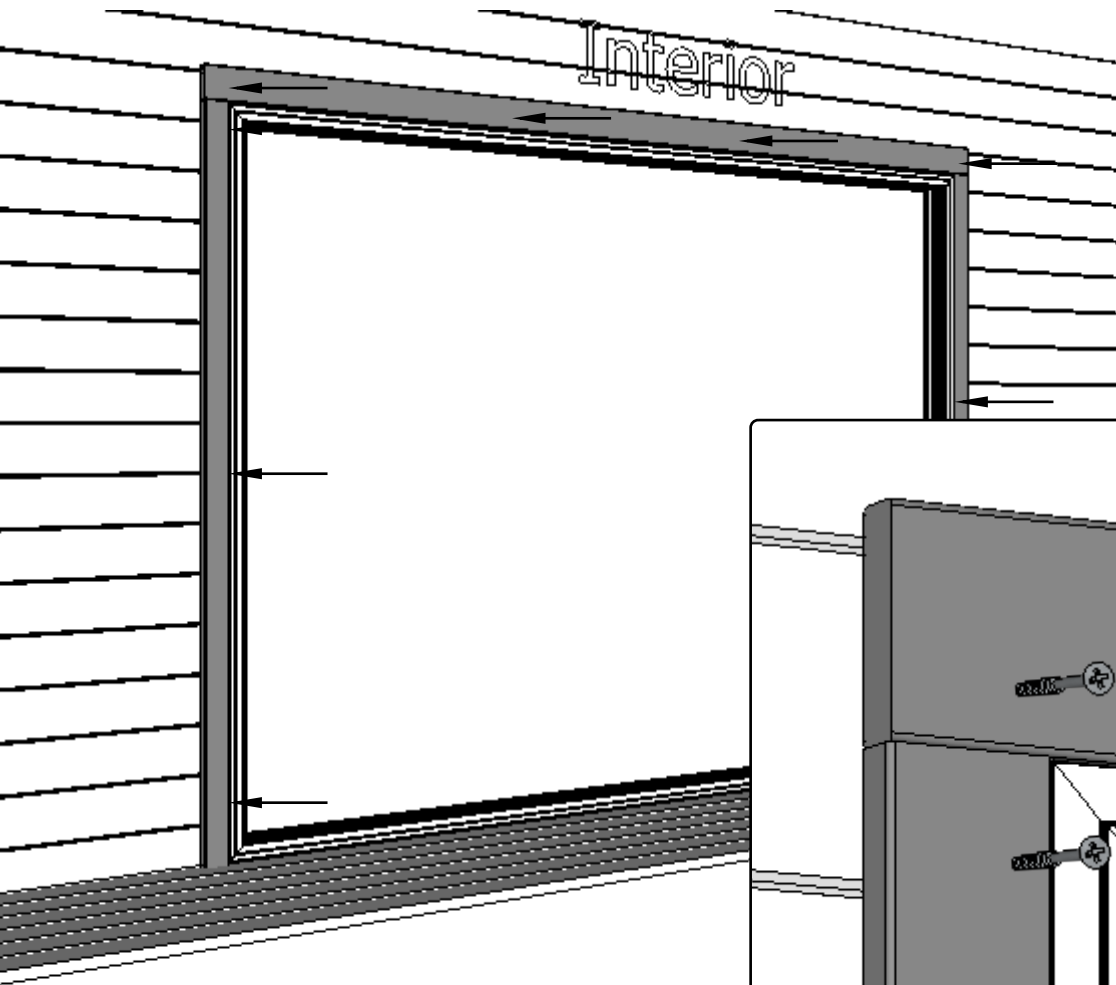

Plan: 15 LU59-5P-7016

Positions:

Exterior

3

2

Wind protective tape

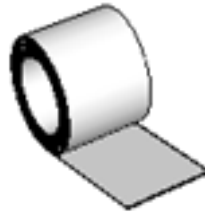

Not included

1

1

XVII

Plan: 15 LU59-5P-7016

Positions: COB



QKRPP3-5x50Zn

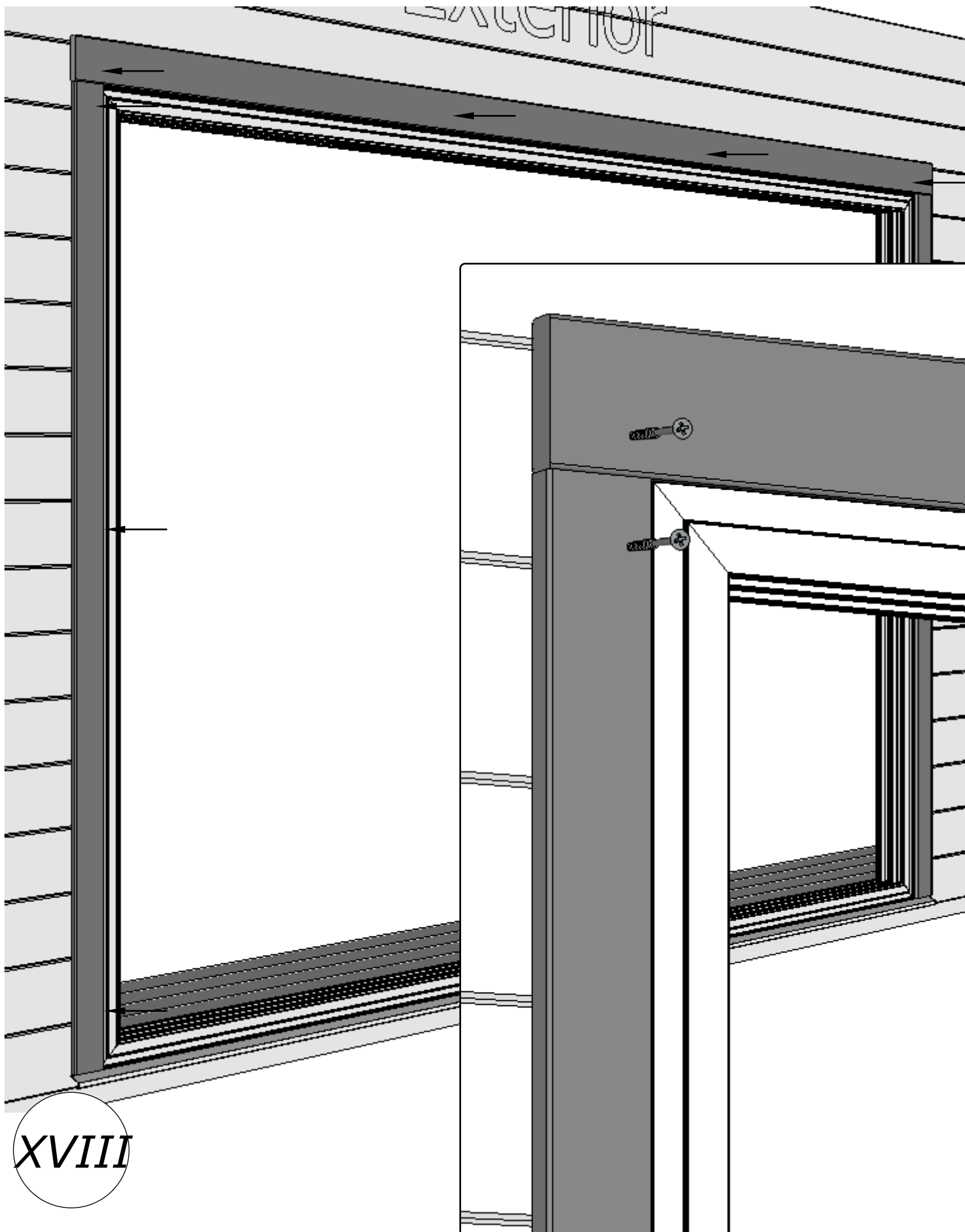

XVIII

Plan: 15 LU59-5P-7016

Positions: COB



QKRPP3-5x50Zn

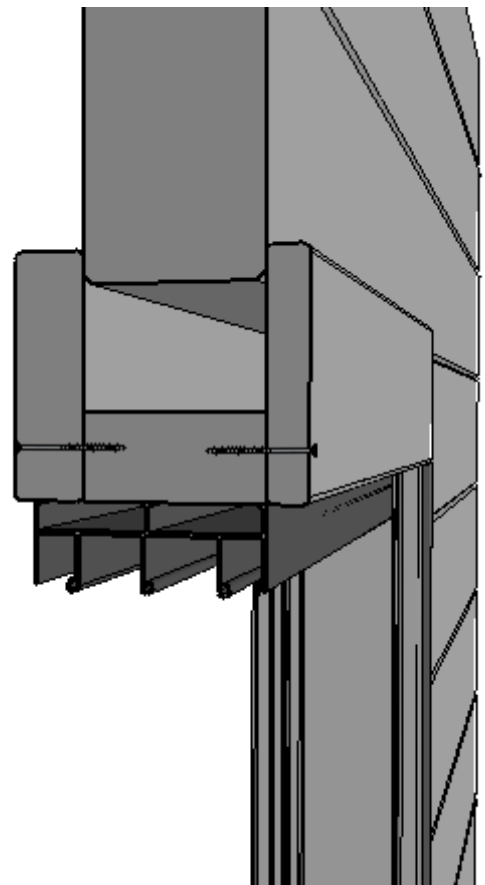
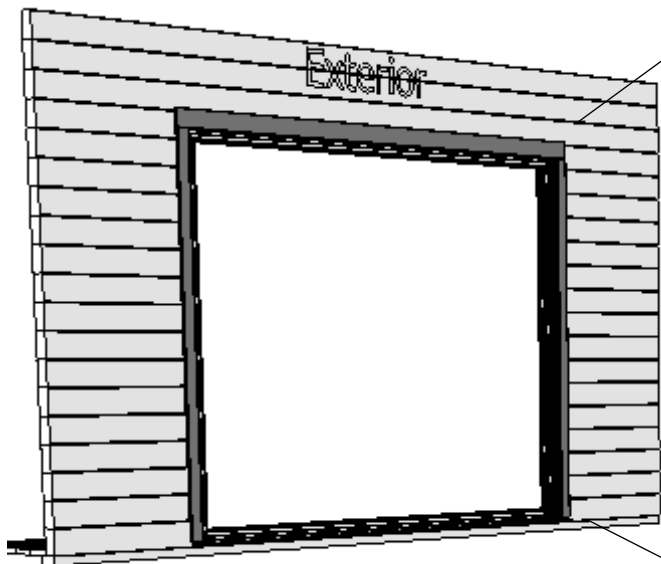

Interior

Exterior

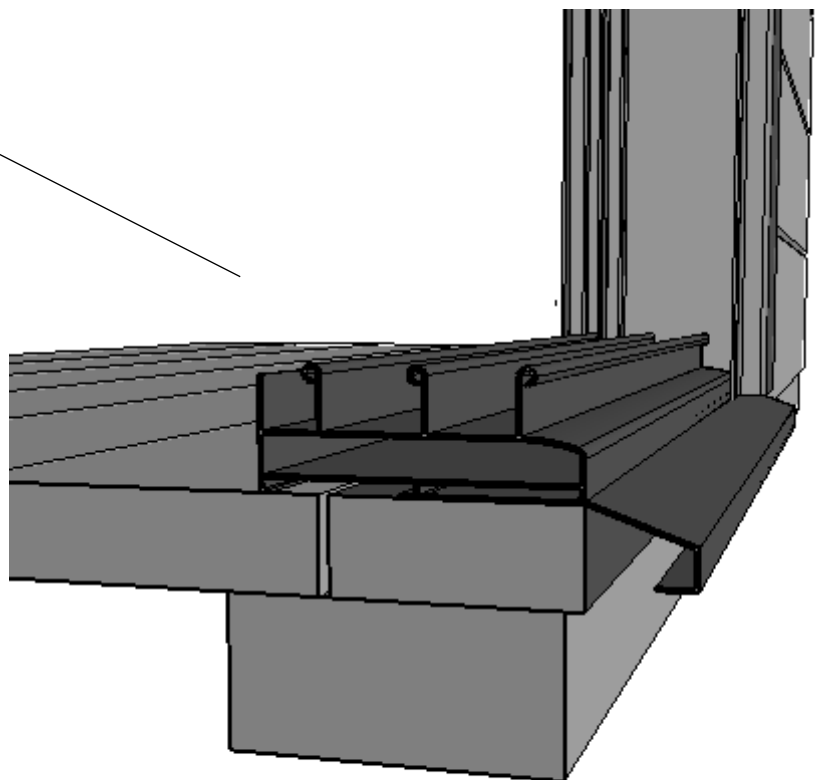

Plan: 15 LU59-5P-7016

Positions:

COB2 - COB8



QKRPP3-5x50Zn

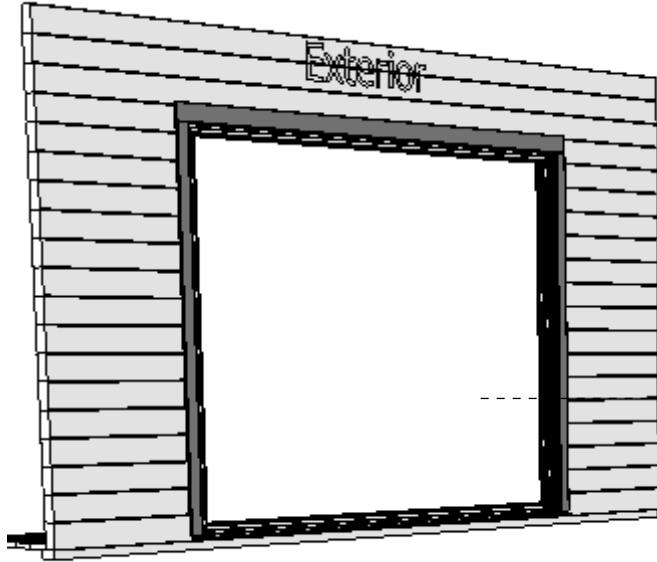

Interior

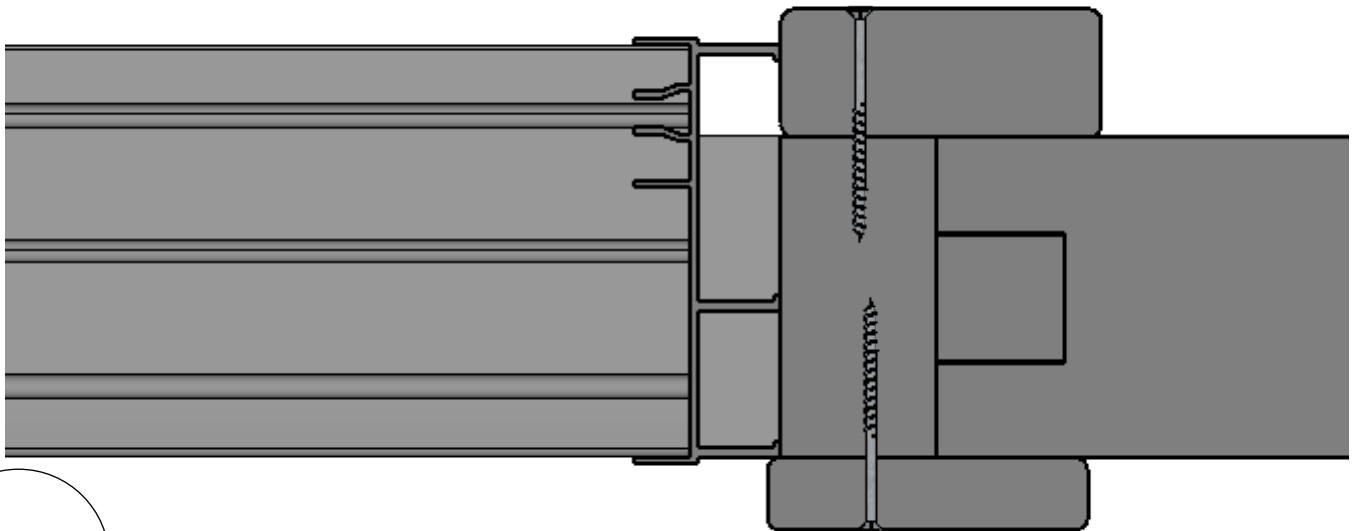

XX

Exterior

Plan: 15 LU59-5P-7016

Positions:

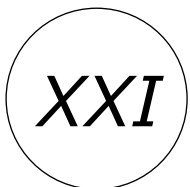
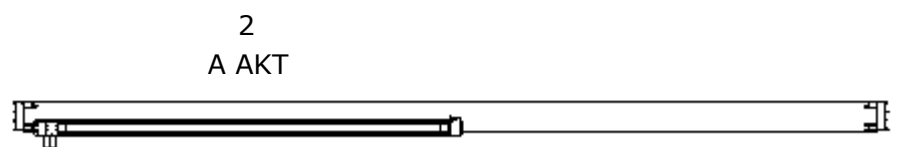
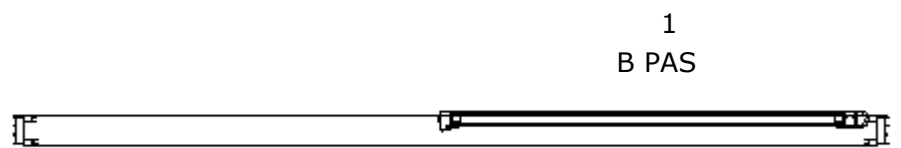
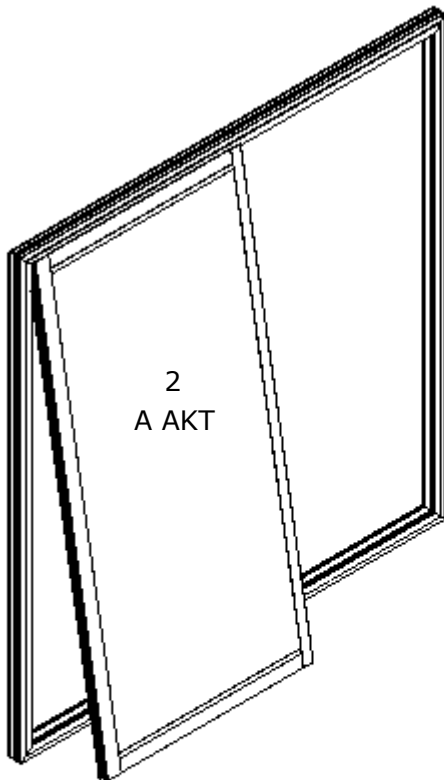
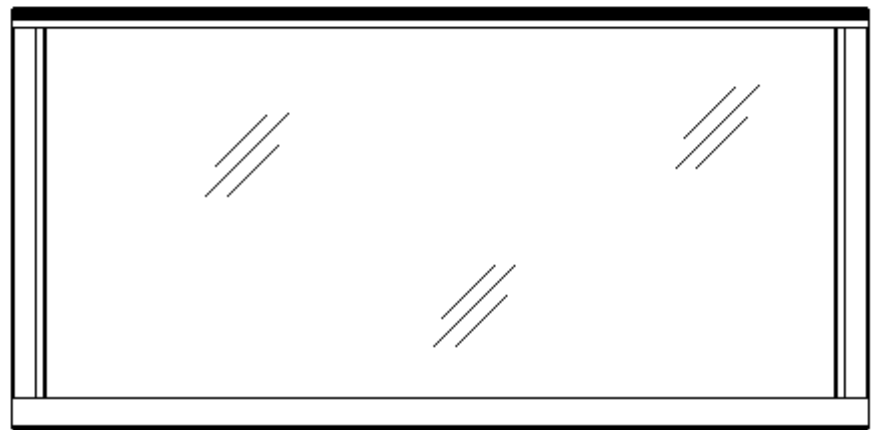
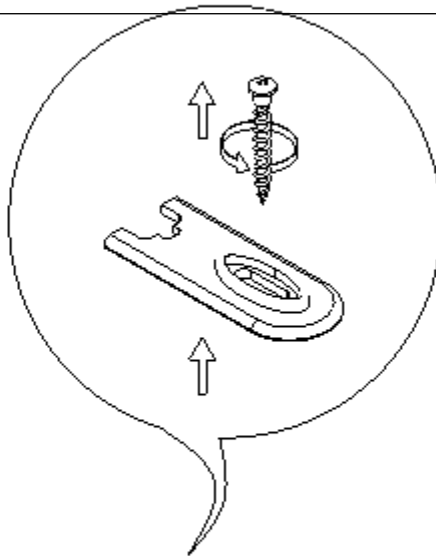
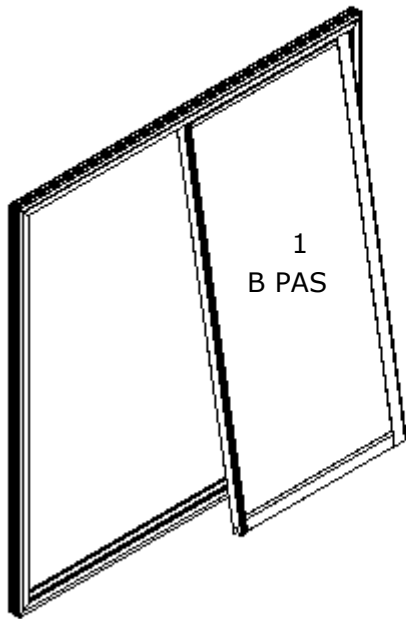



Plan: 15 LU59-5P-7016

Positions:

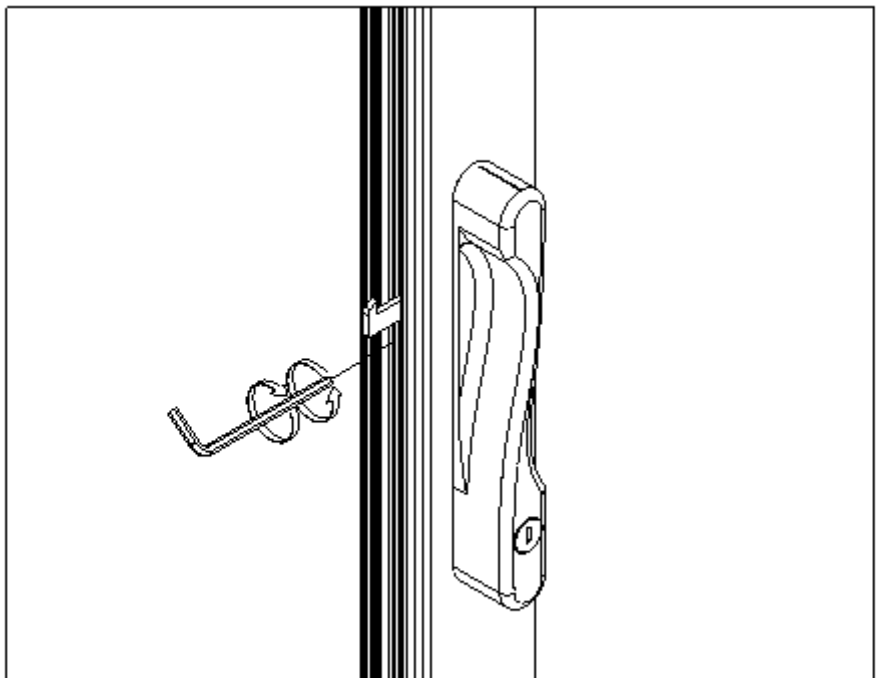
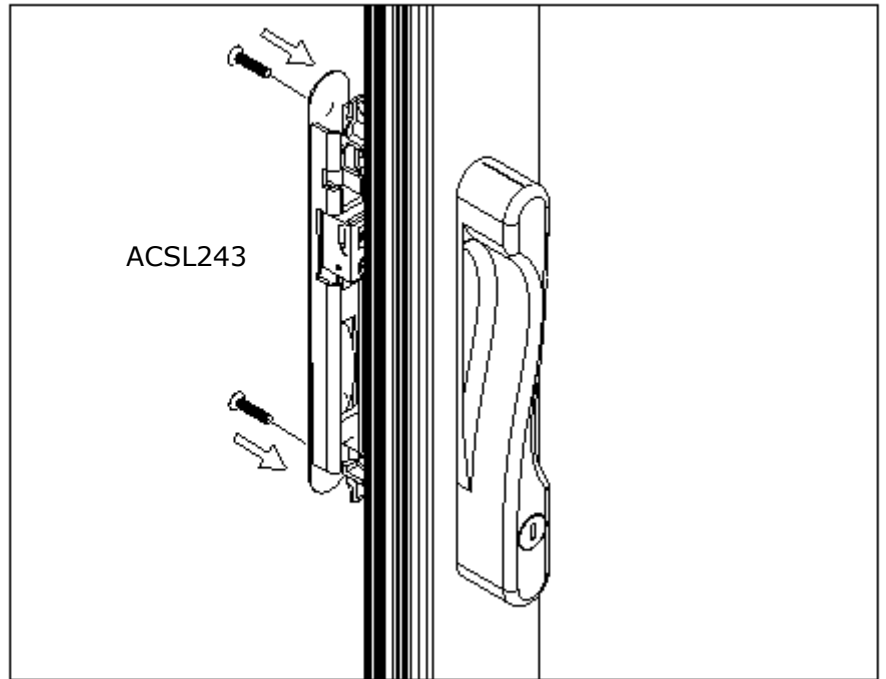
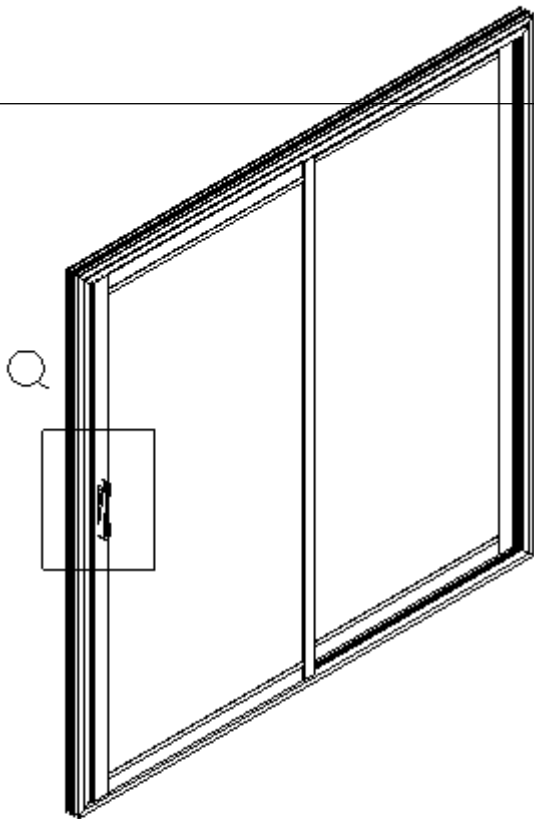

Plan: 15 LU59-5P-7016

Positions:

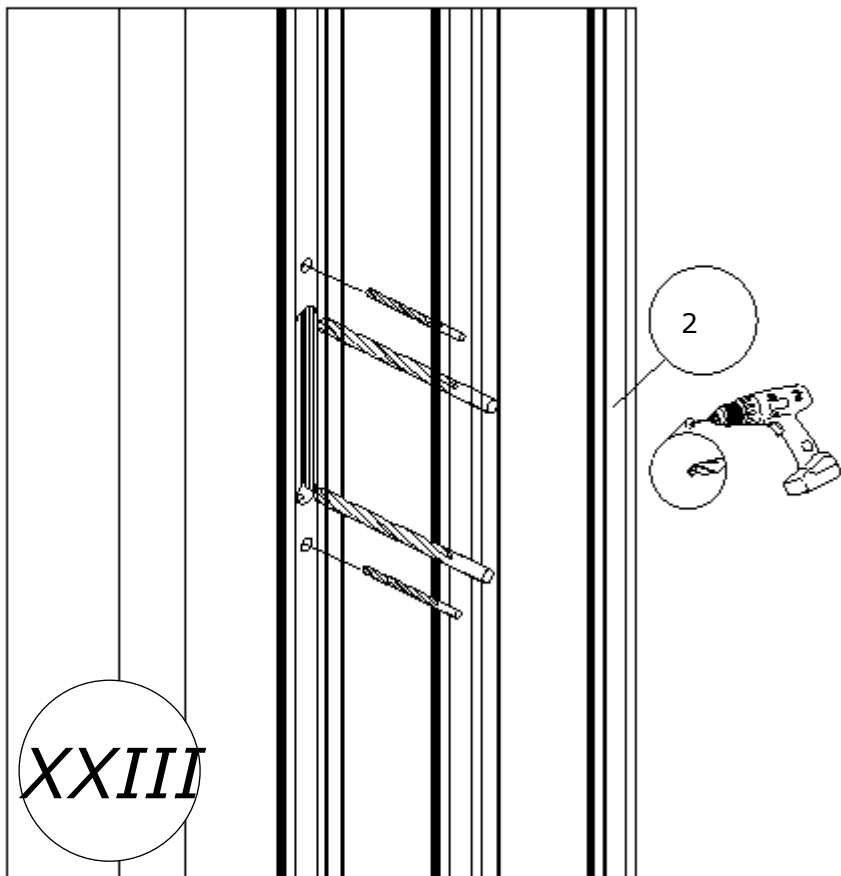
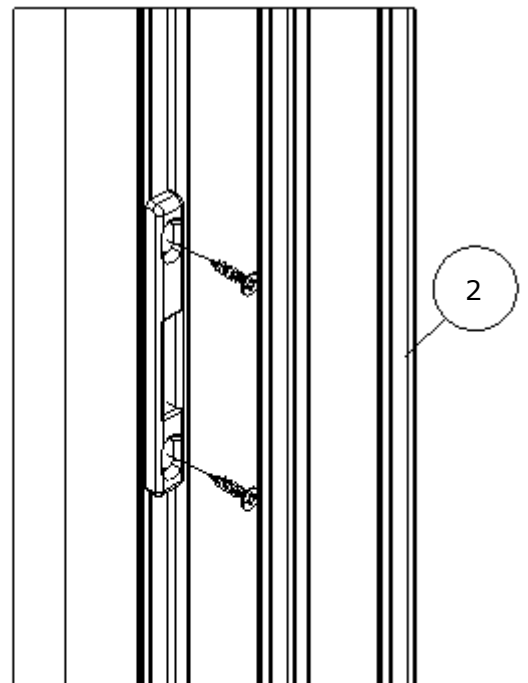
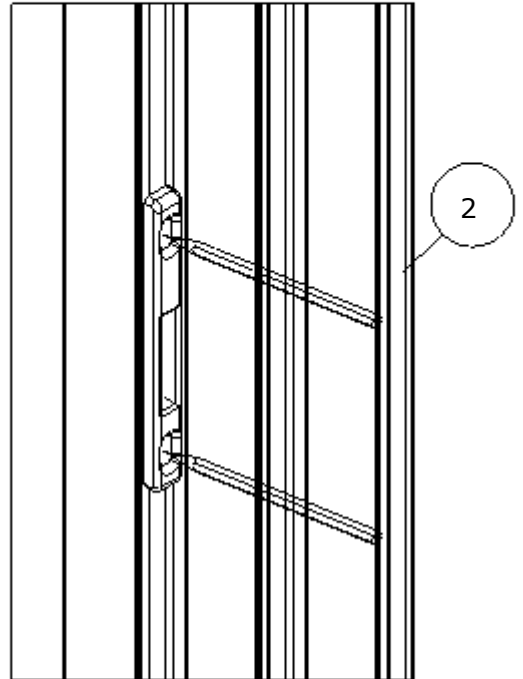
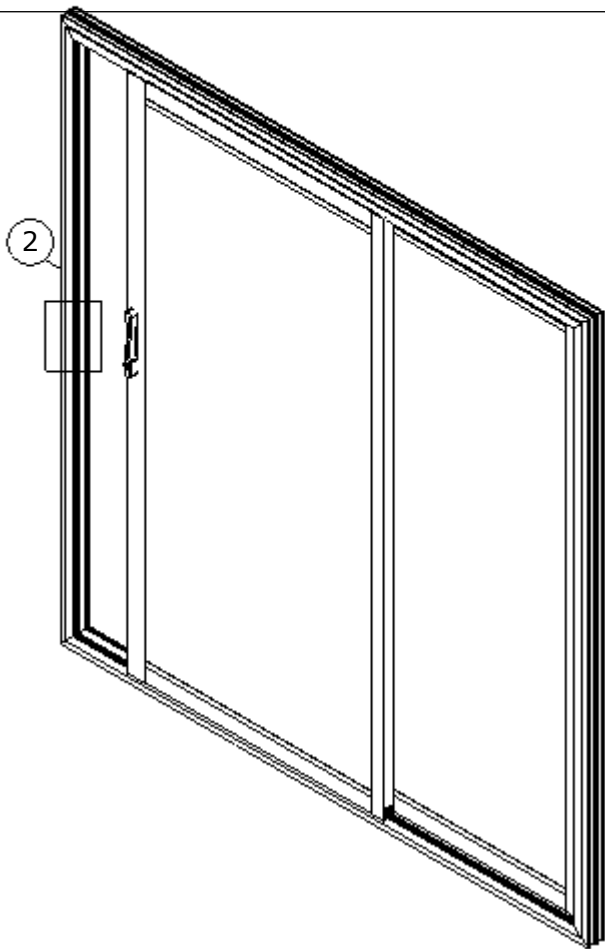

Plan: 15 LU59-5P-7016

Positions:

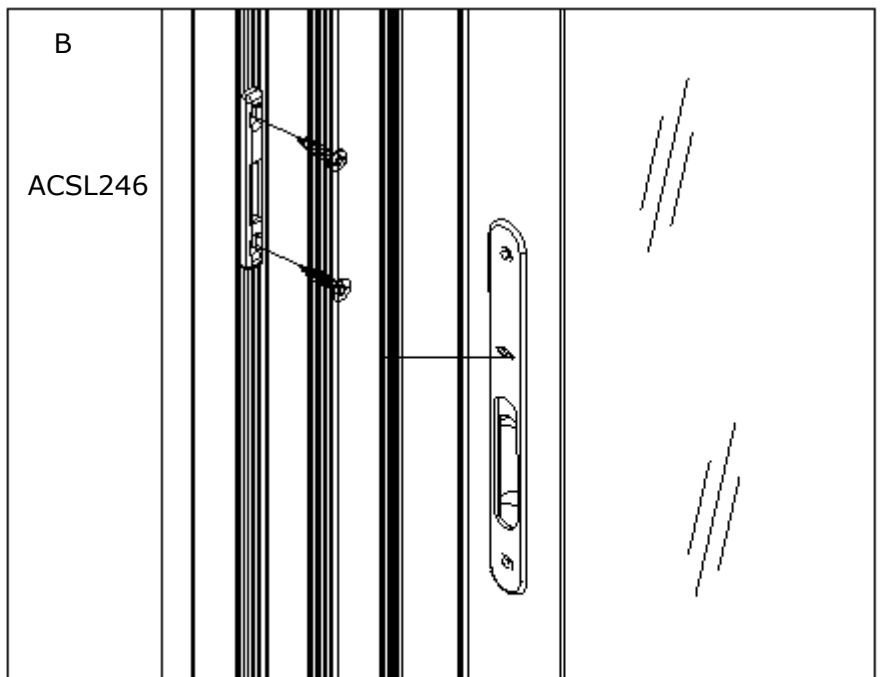
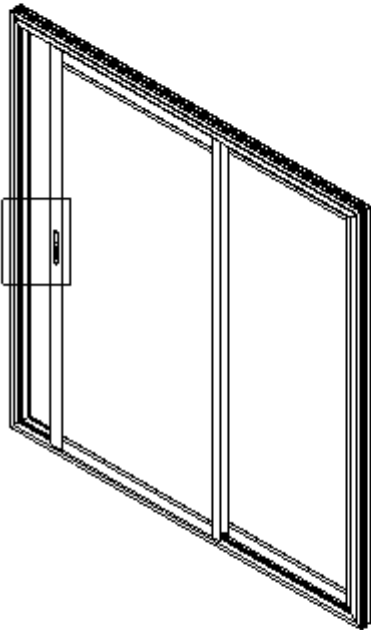
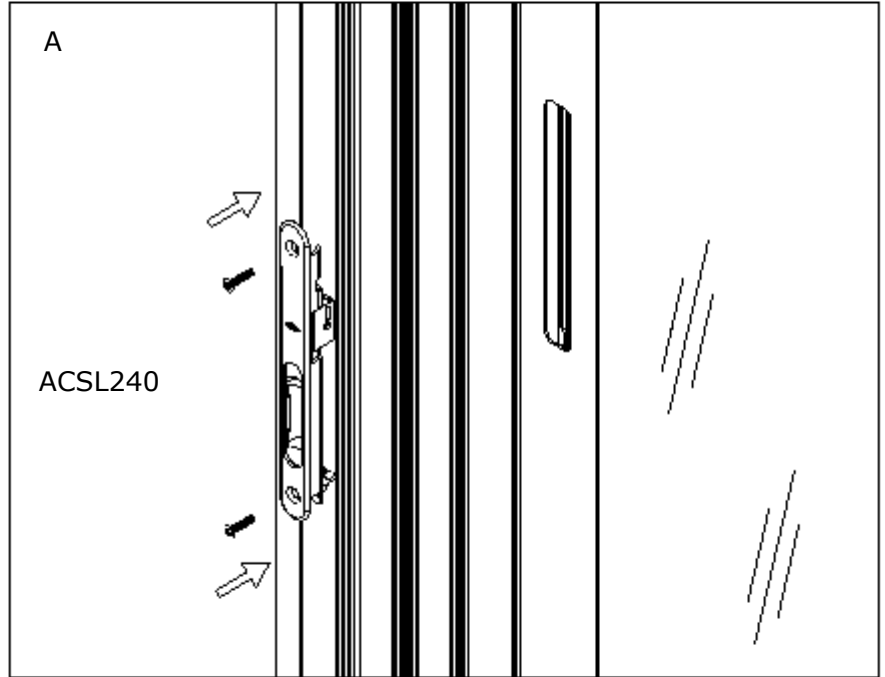
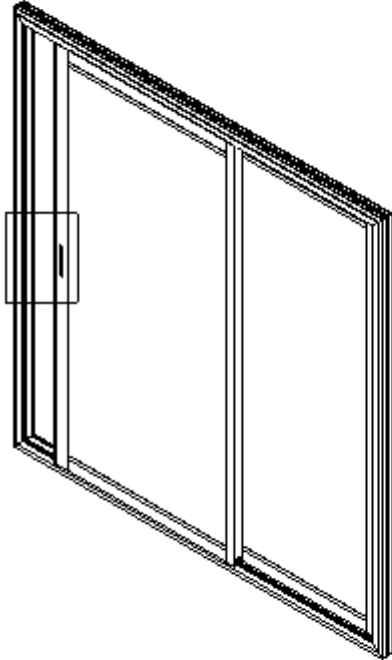

Plan: 15 LU59-5P-7016

Positions:

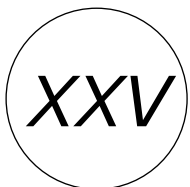
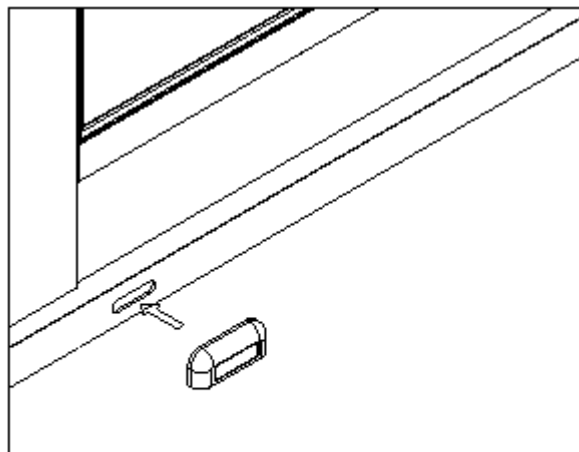
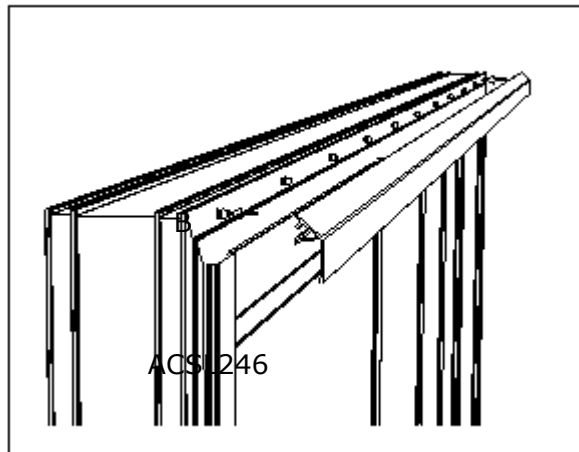
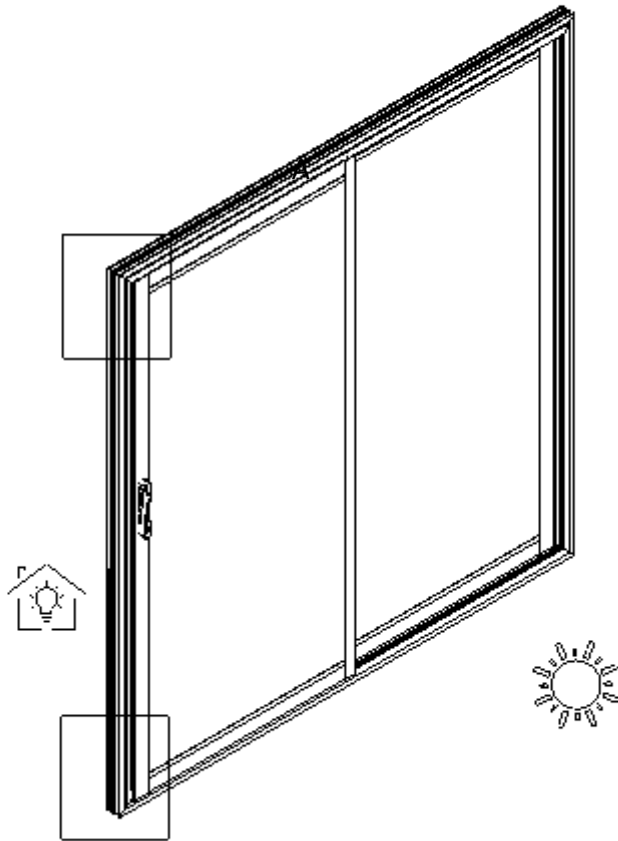

Plan: 15-A LU104-5P-7016

Positions:

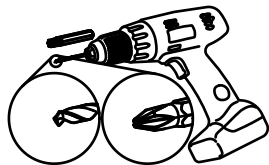
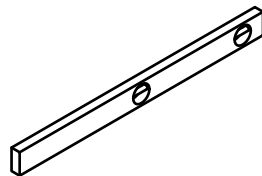
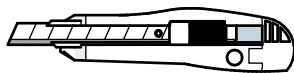
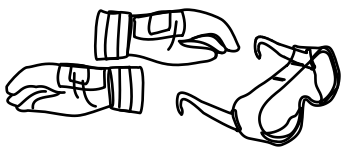
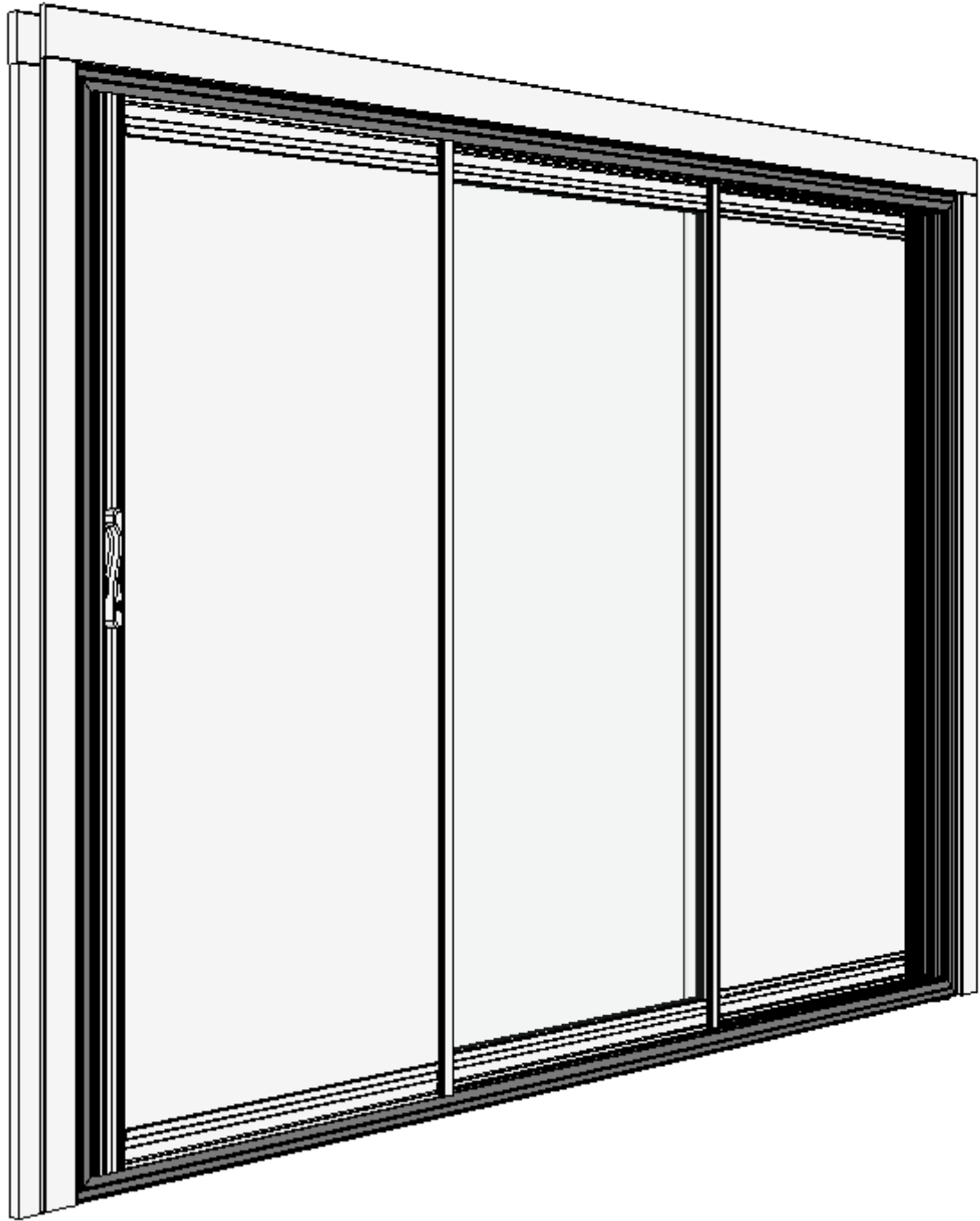

*I*

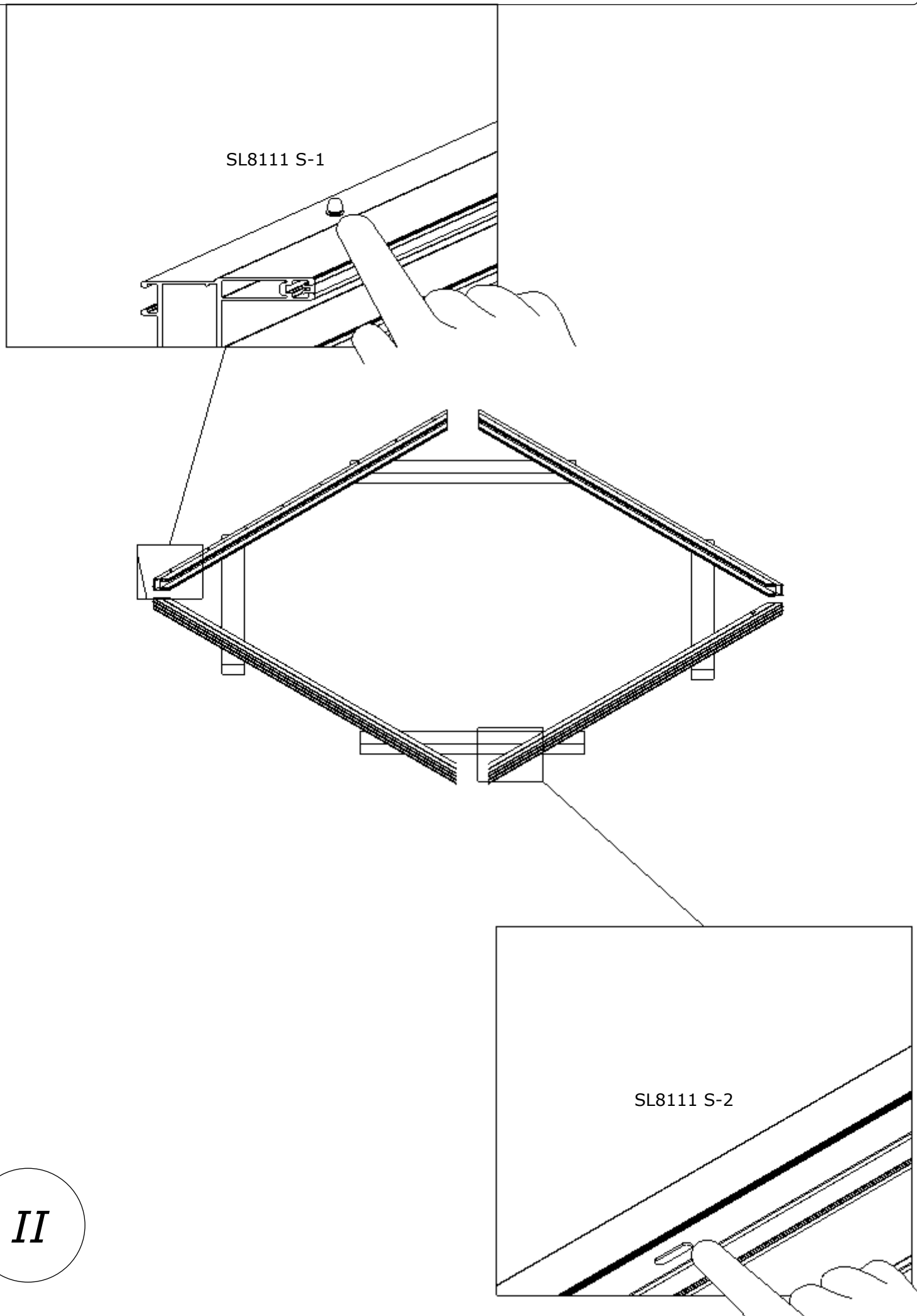

Plan: 15-A LU104-5P-7016

Positions:

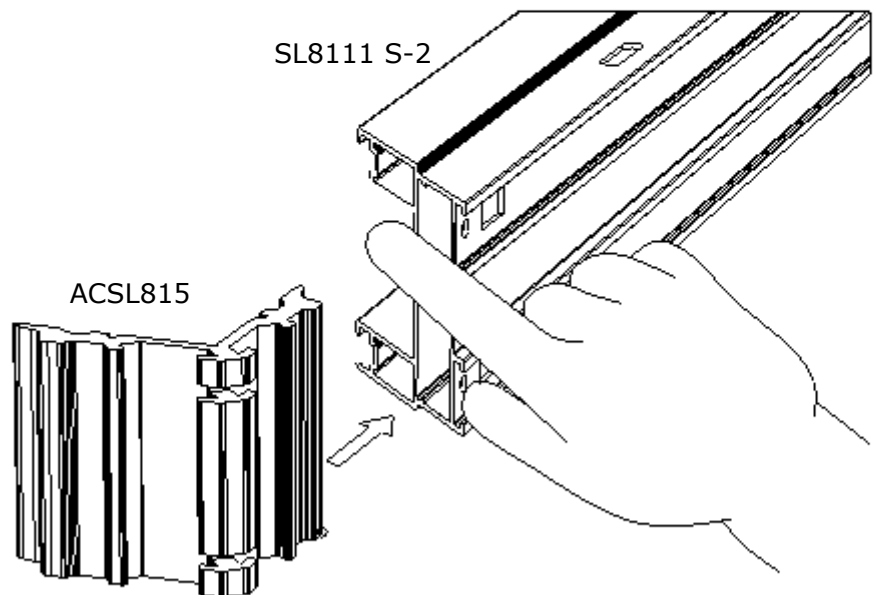
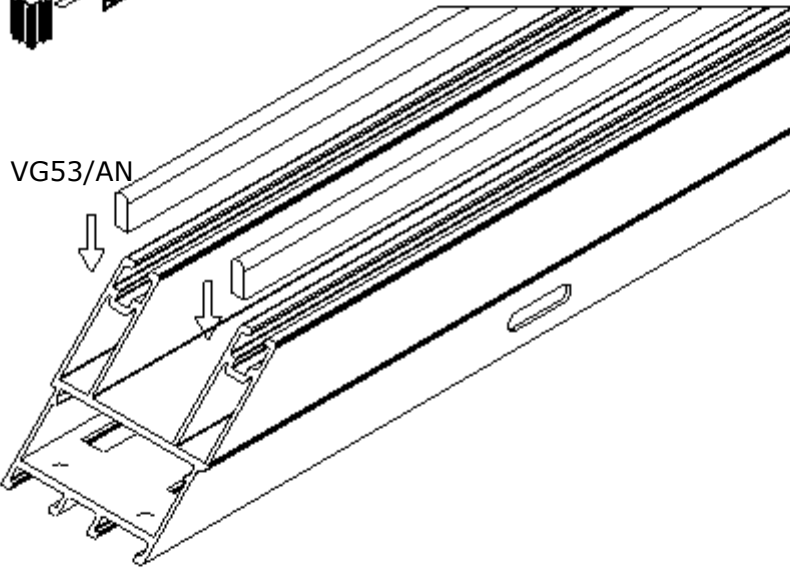
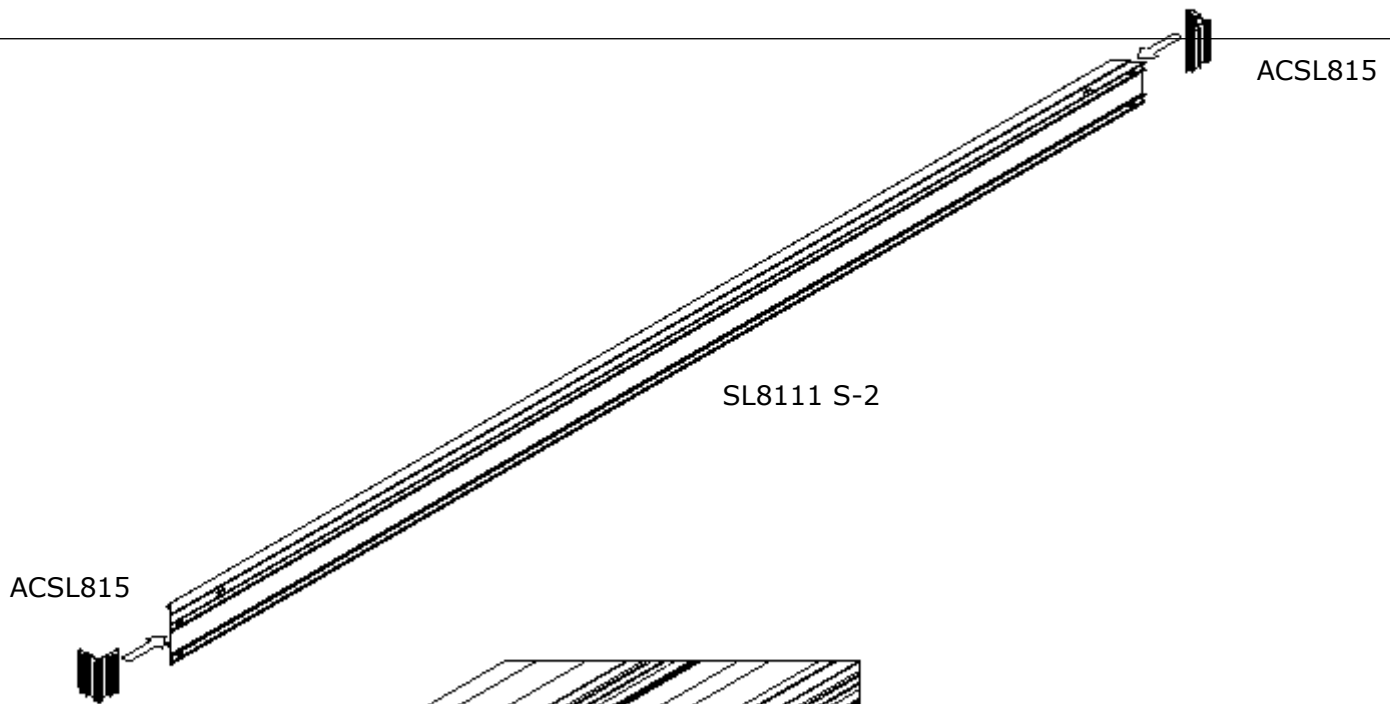

Plan: 15-A LU104-5P-7016

Positions:

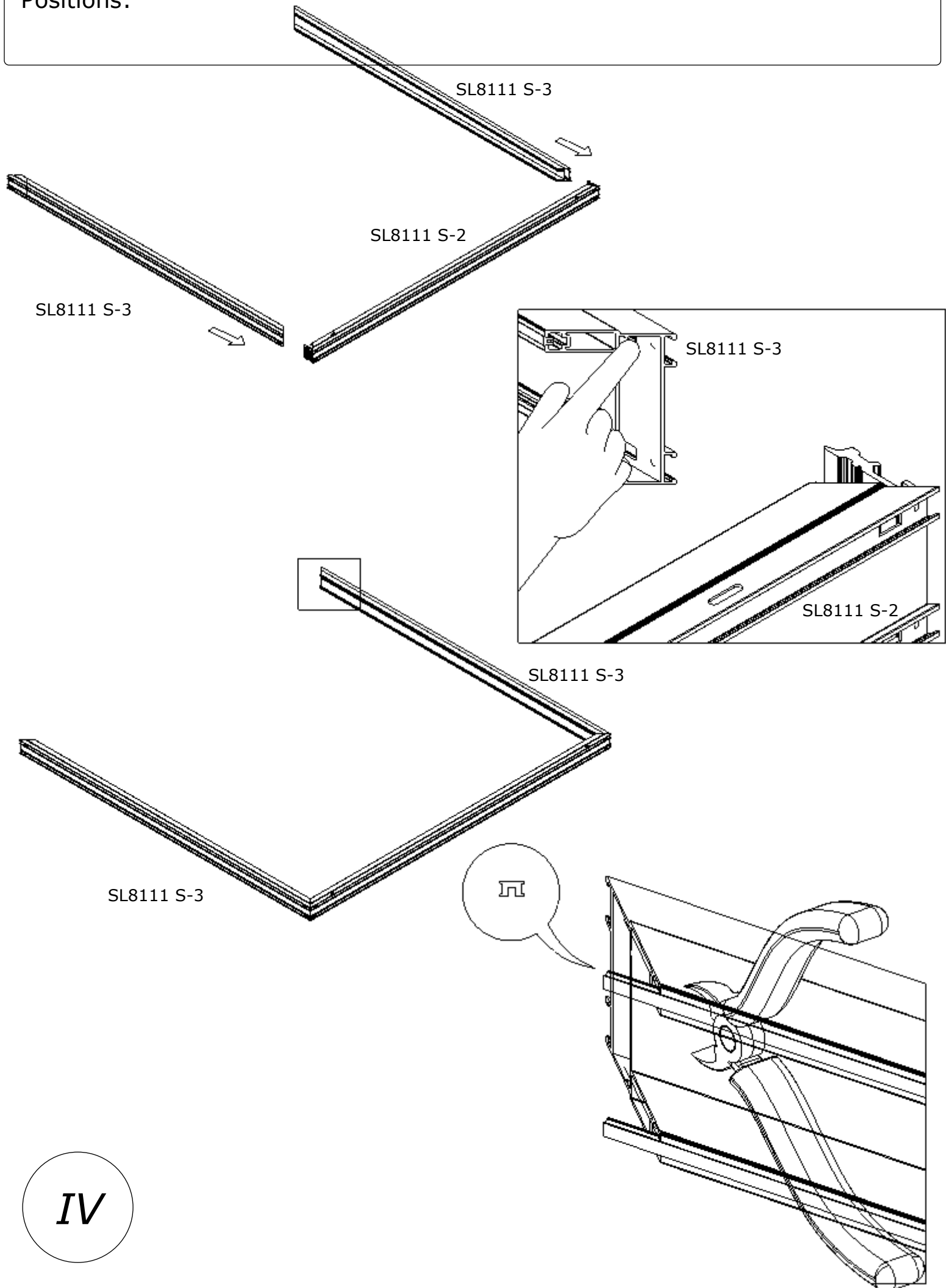



Plan: 15-A LU104-5P-7016

Positions:

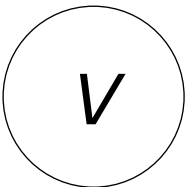
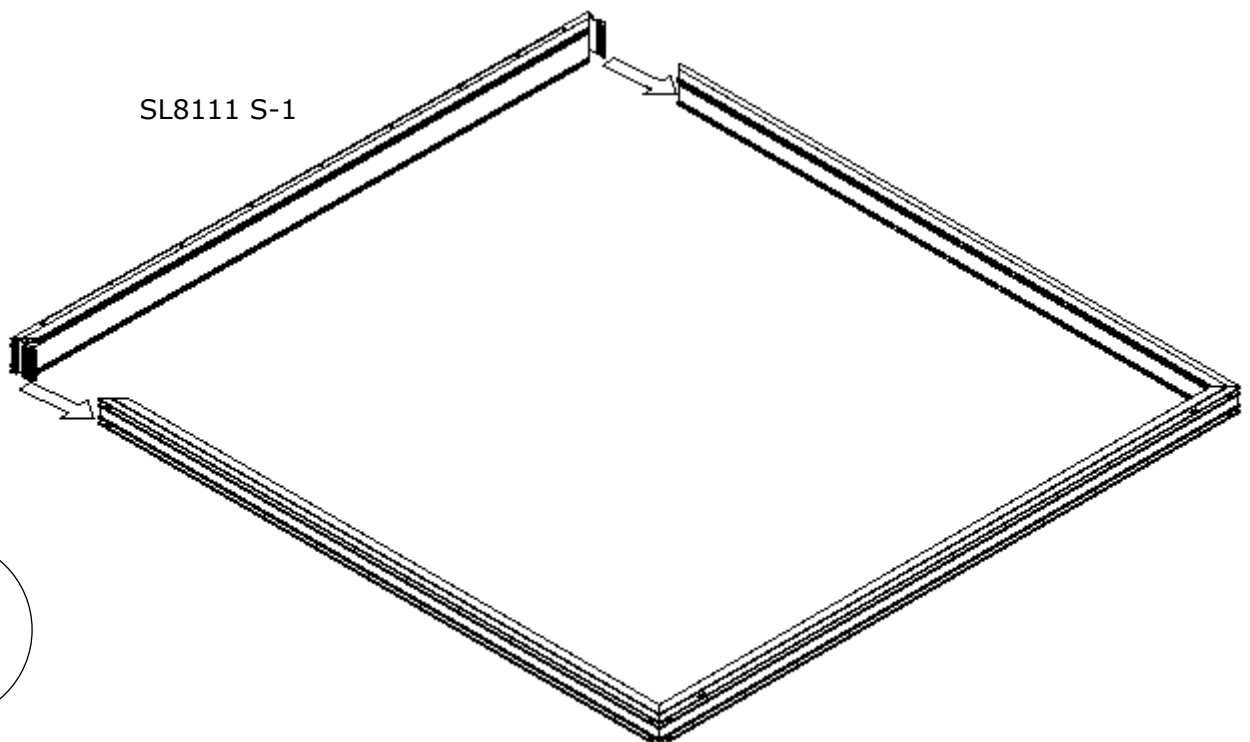
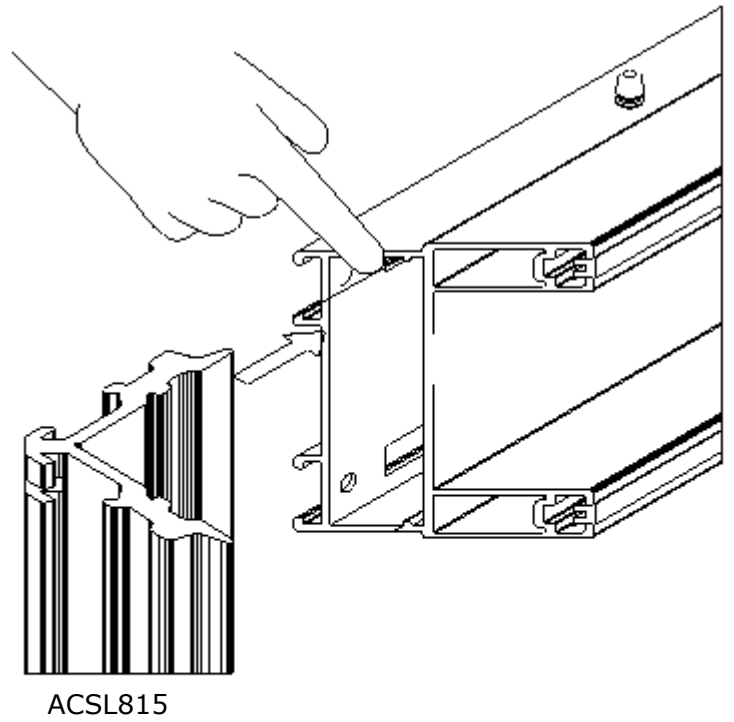
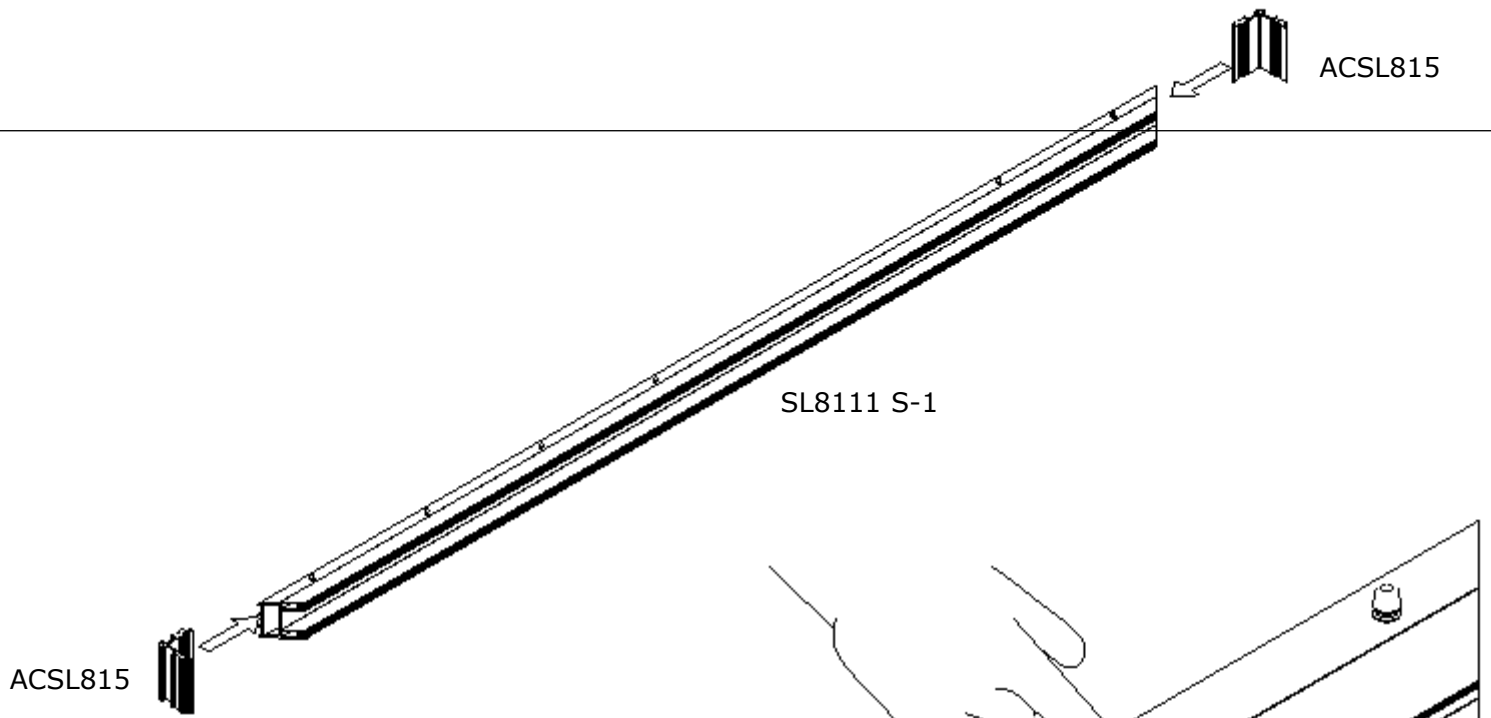

Plan: 15-A LU104-5P-7016

Positions:

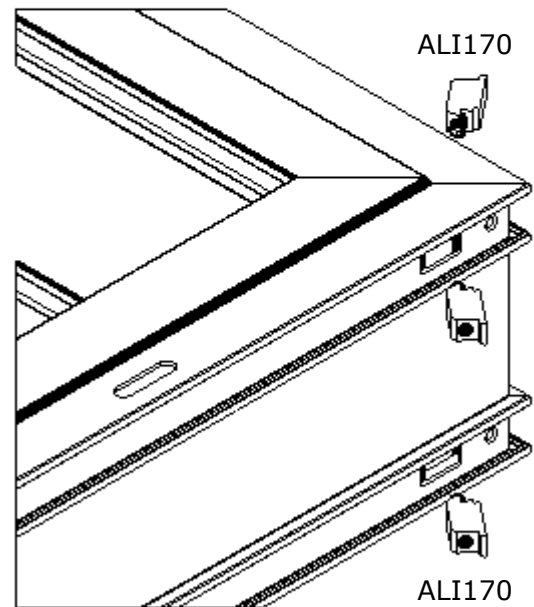
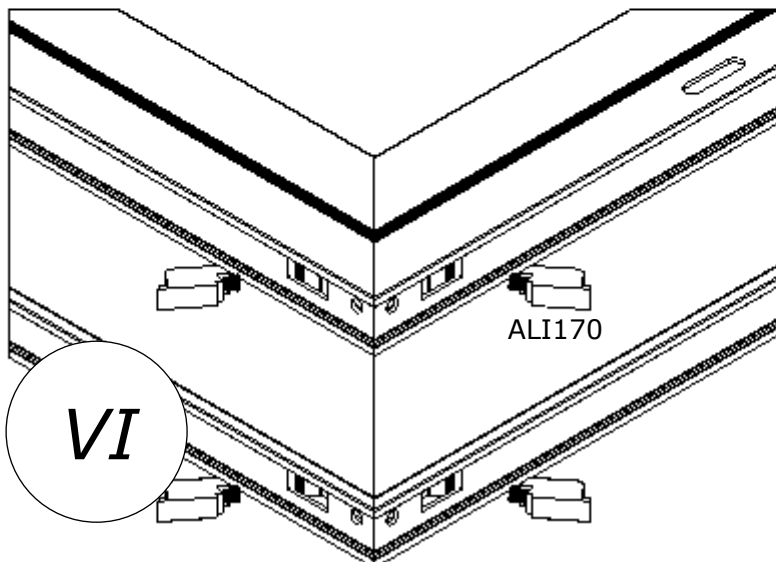
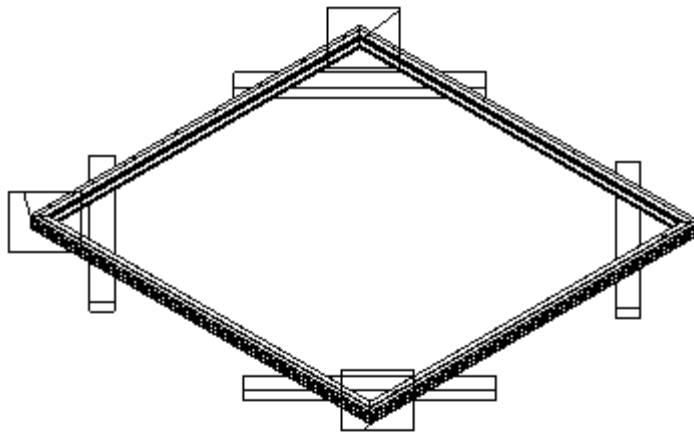
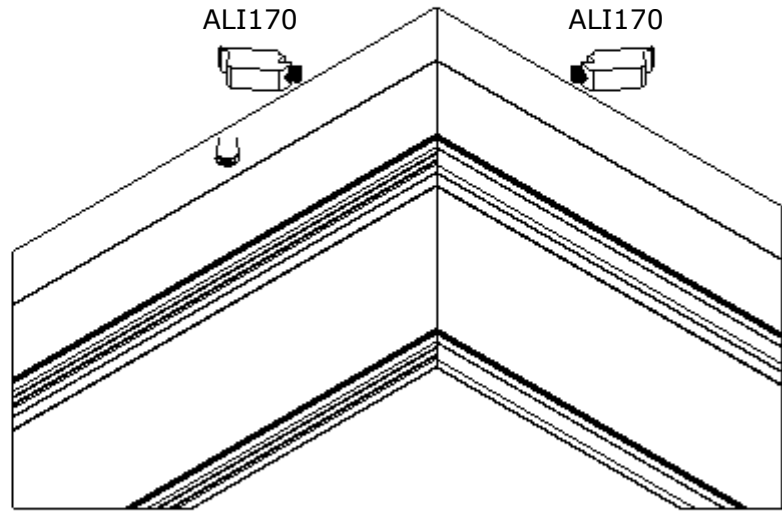
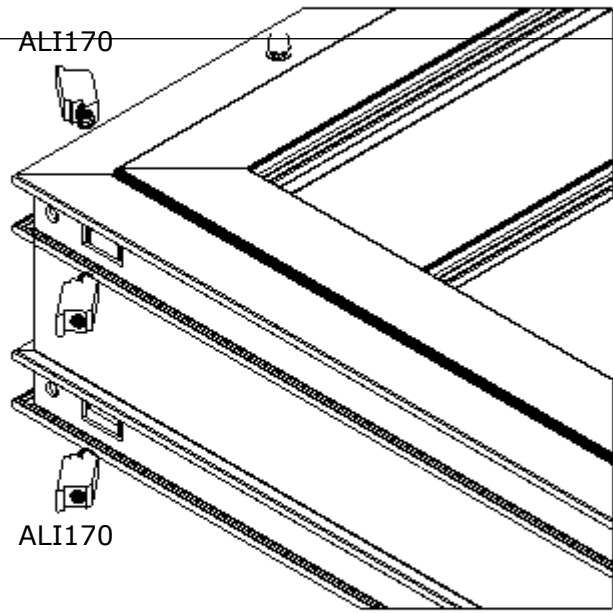

Plan: 15-A LU104-5P-7016

Positions:

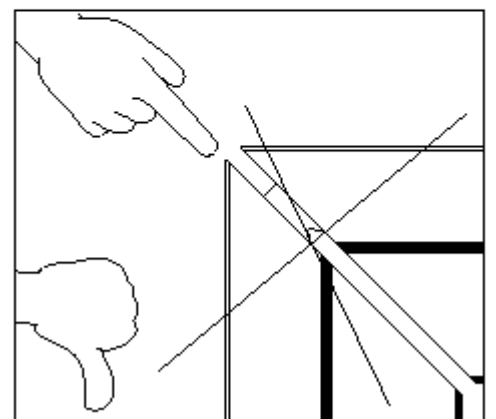
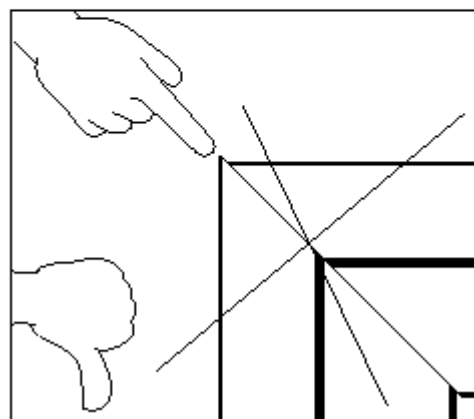
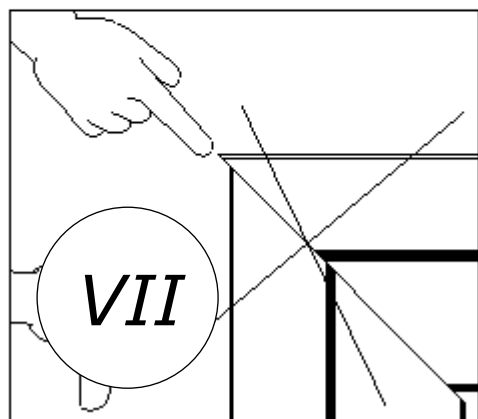
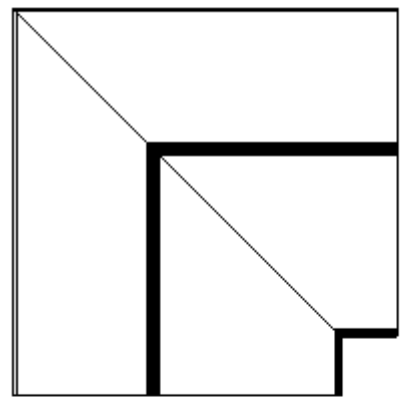
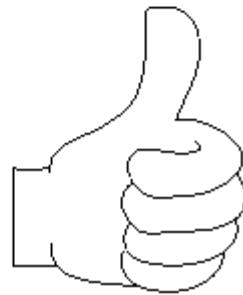
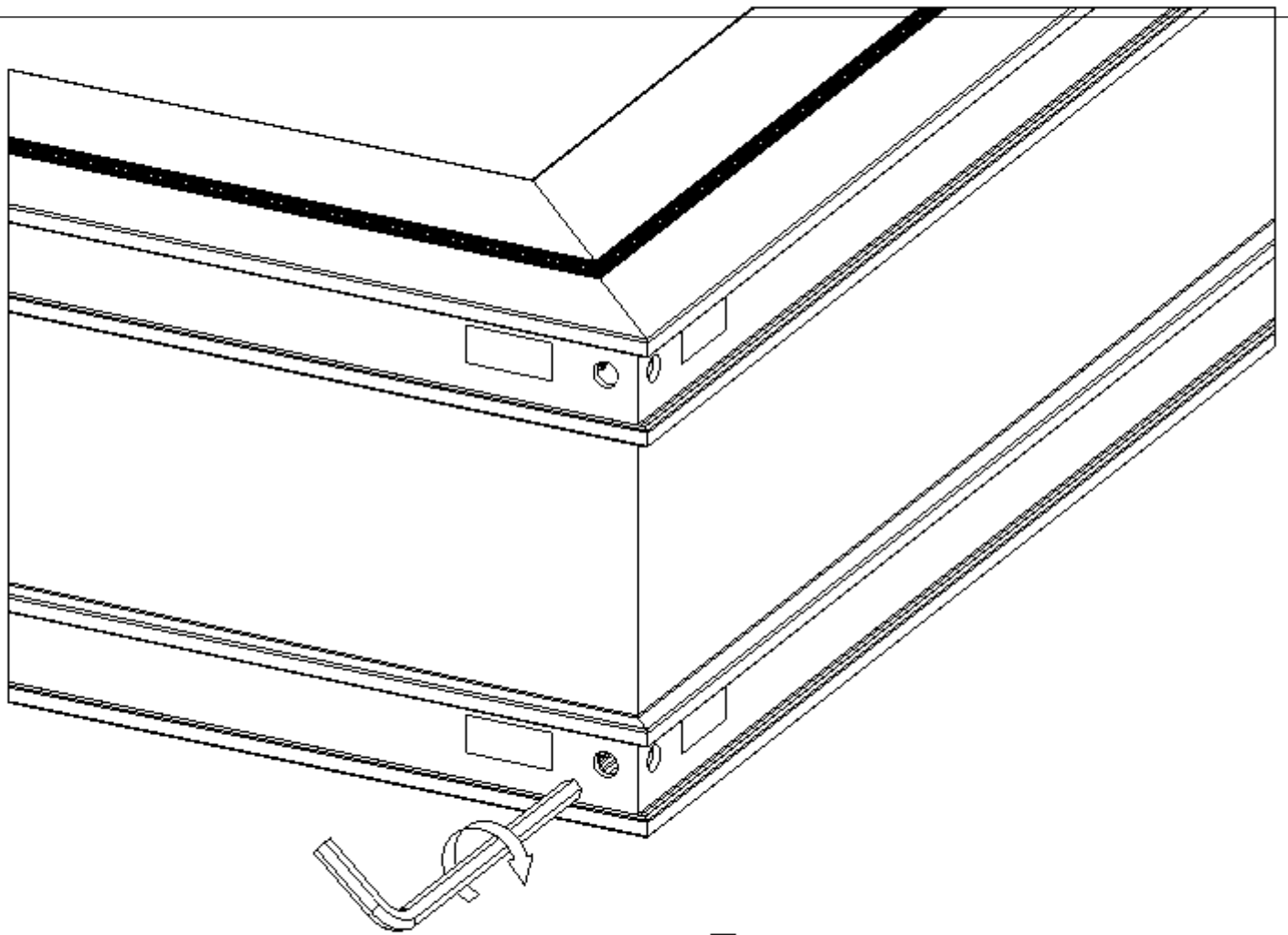

Plan: 15-A LU104-5P-7016

Positions: TP, Sis



QKRPP3-5x50Zn

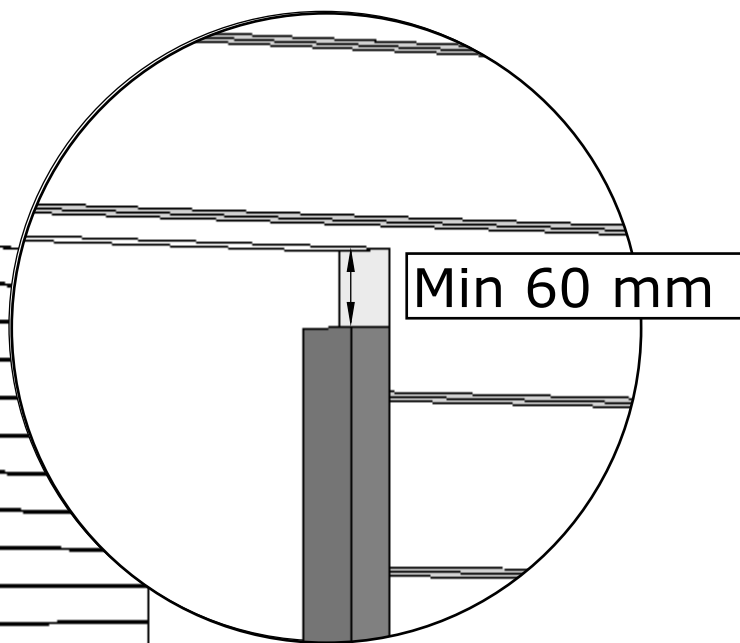
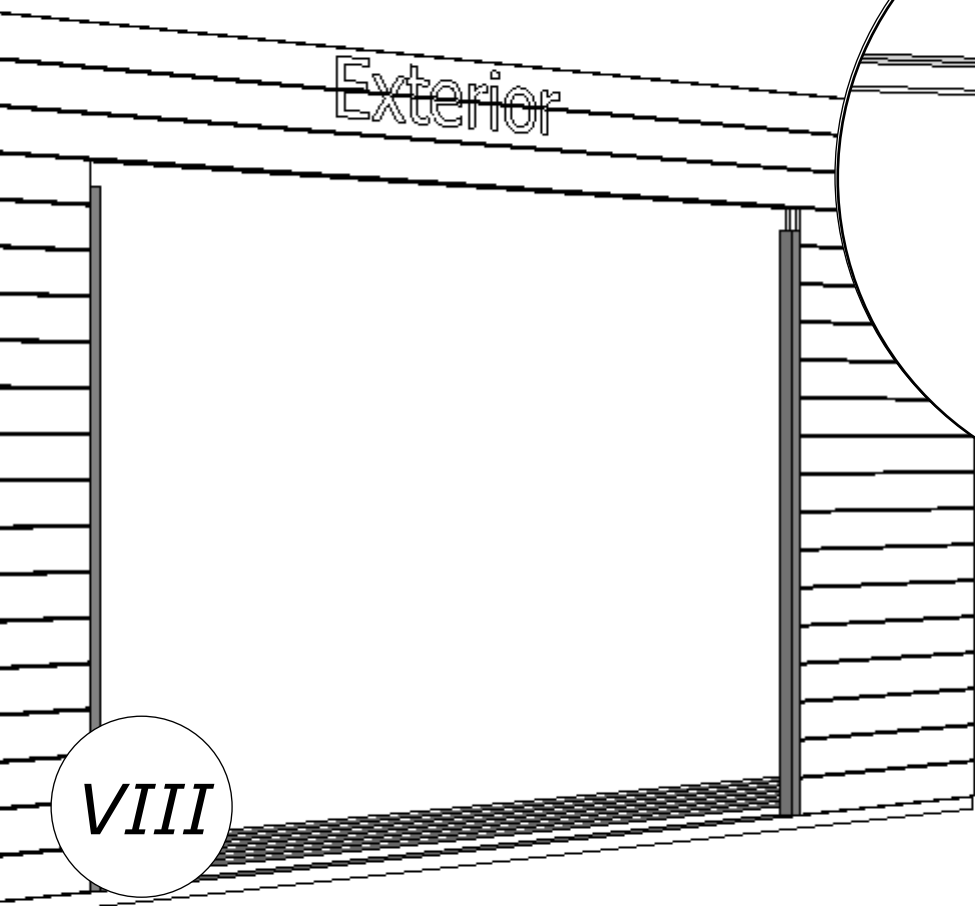
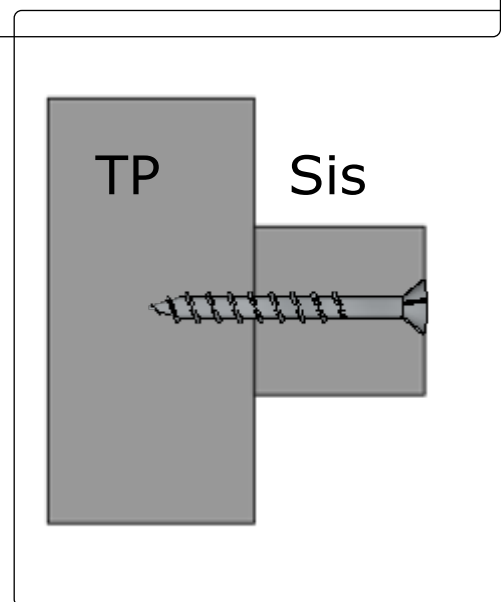
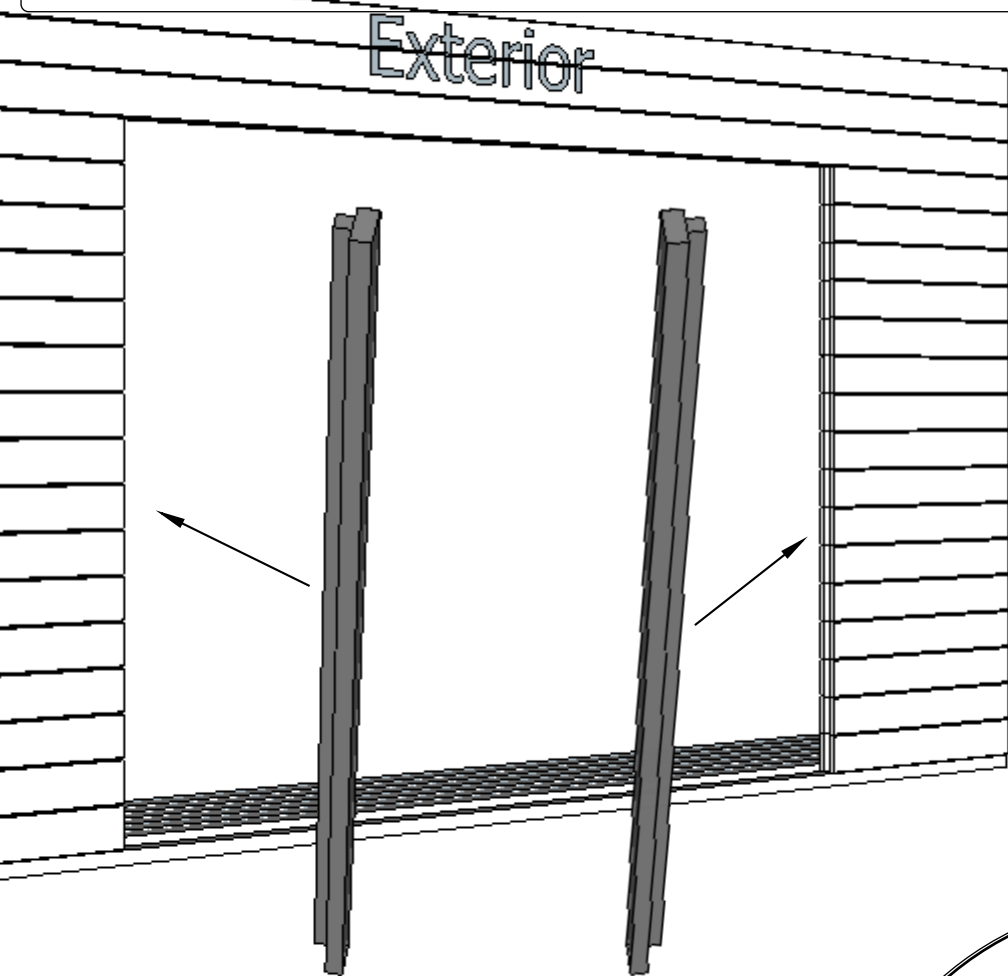

VIII

Plan: 15-A LU104-5P-7016

Positions: Sla



QKRPP3-5x50Zn

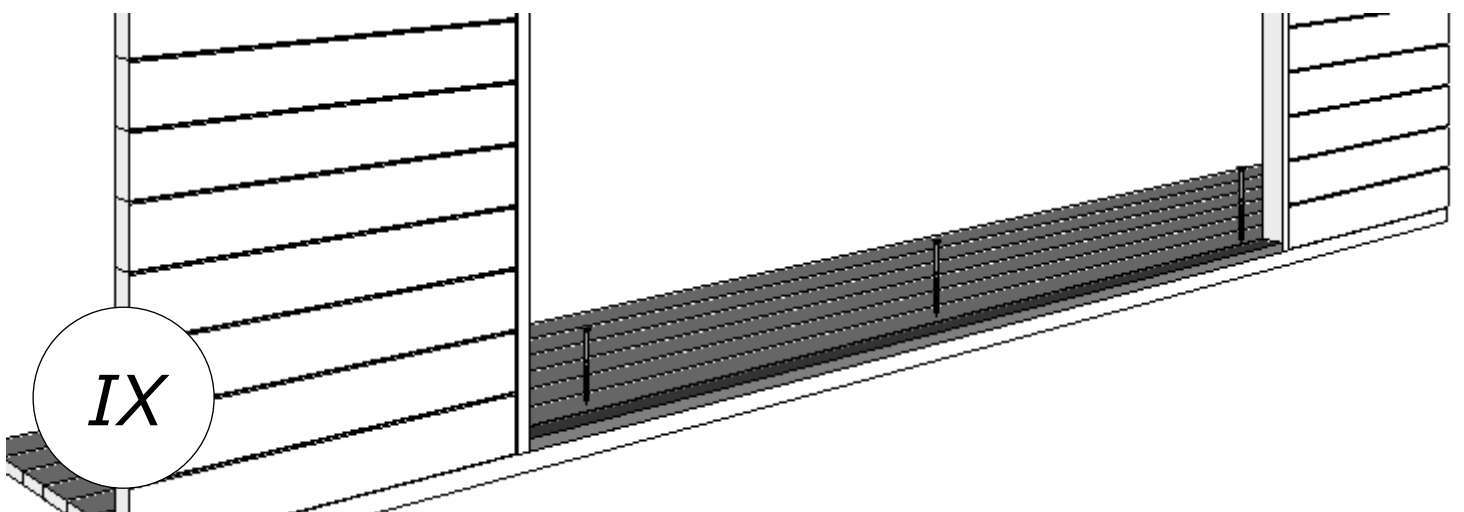
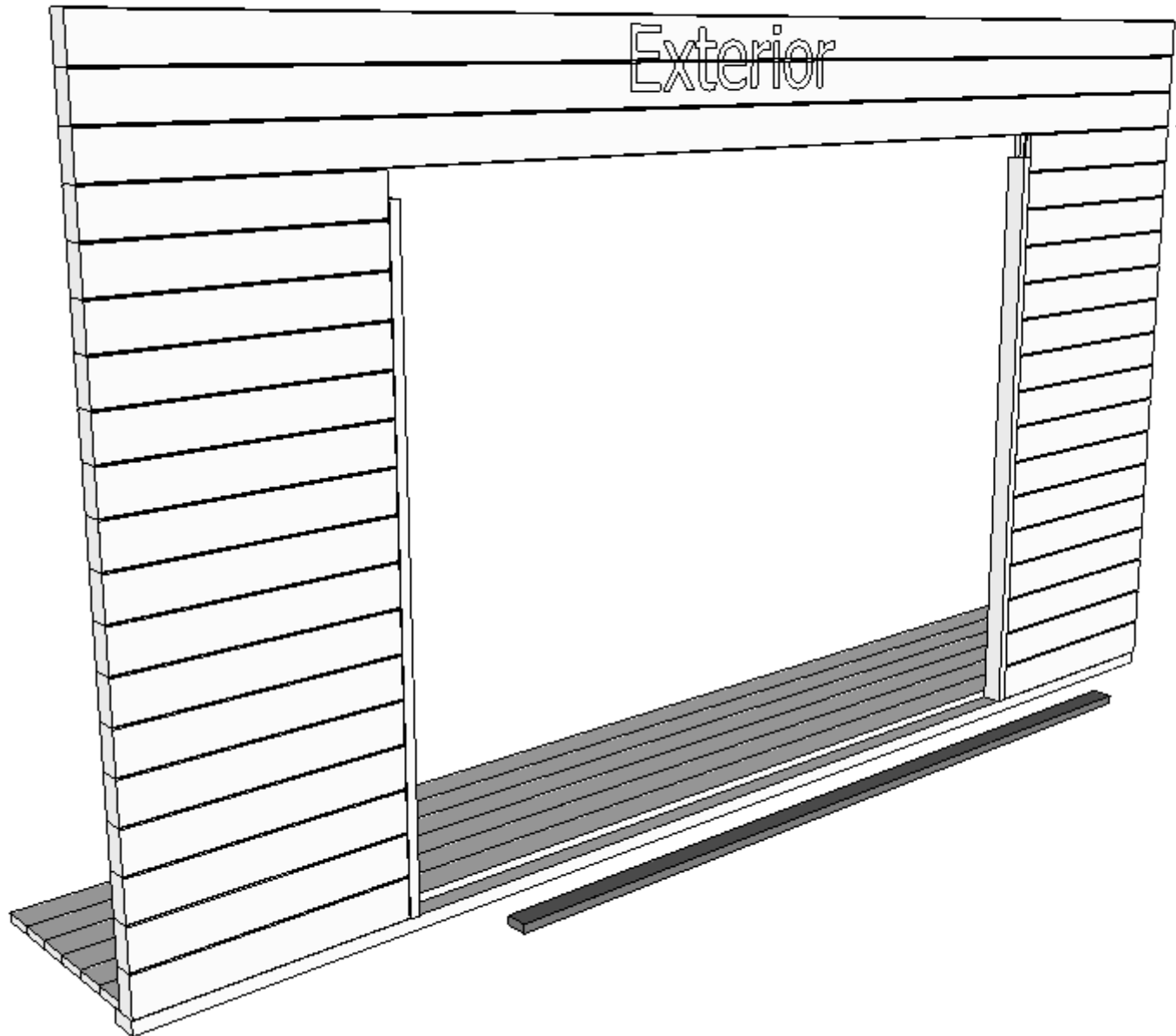

Plan: 15-A LU104-5P-7016

Positions: QP40x30x2858MU

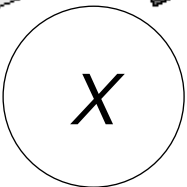
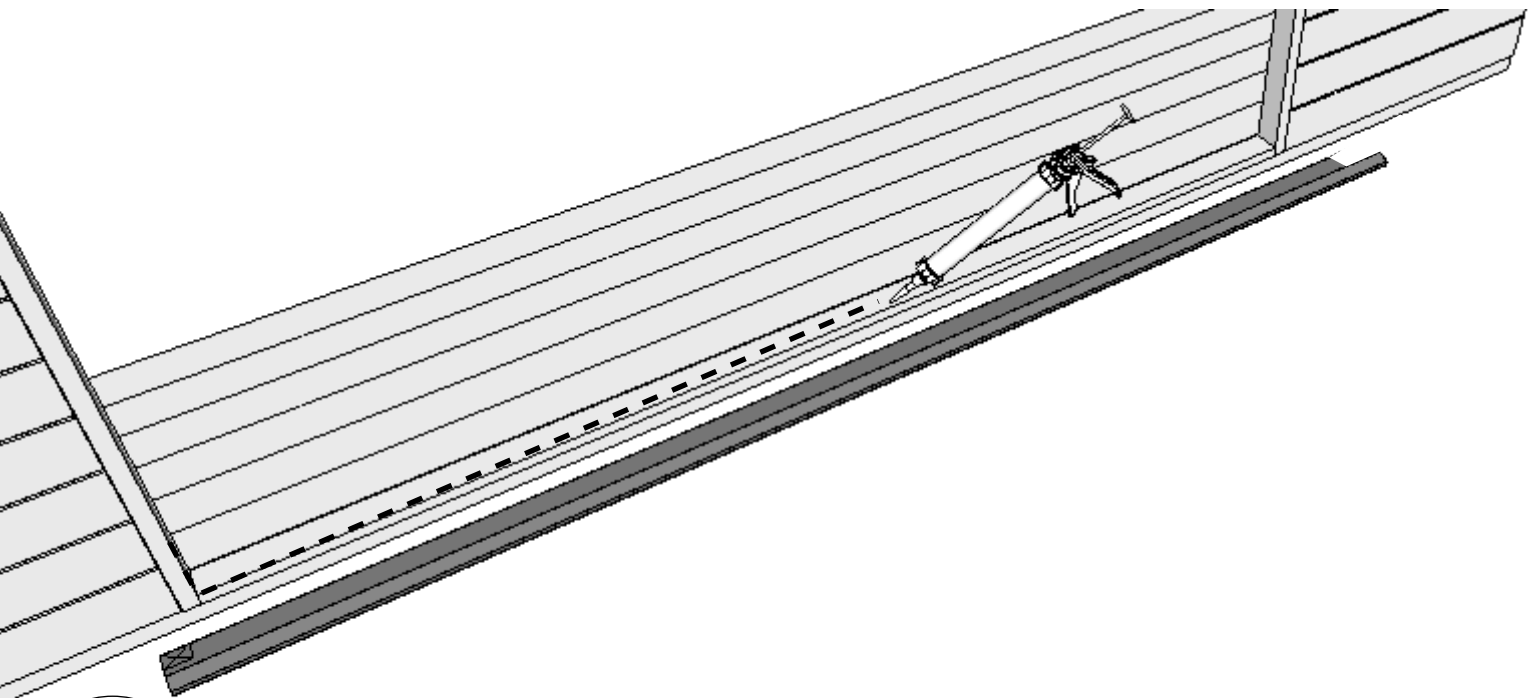
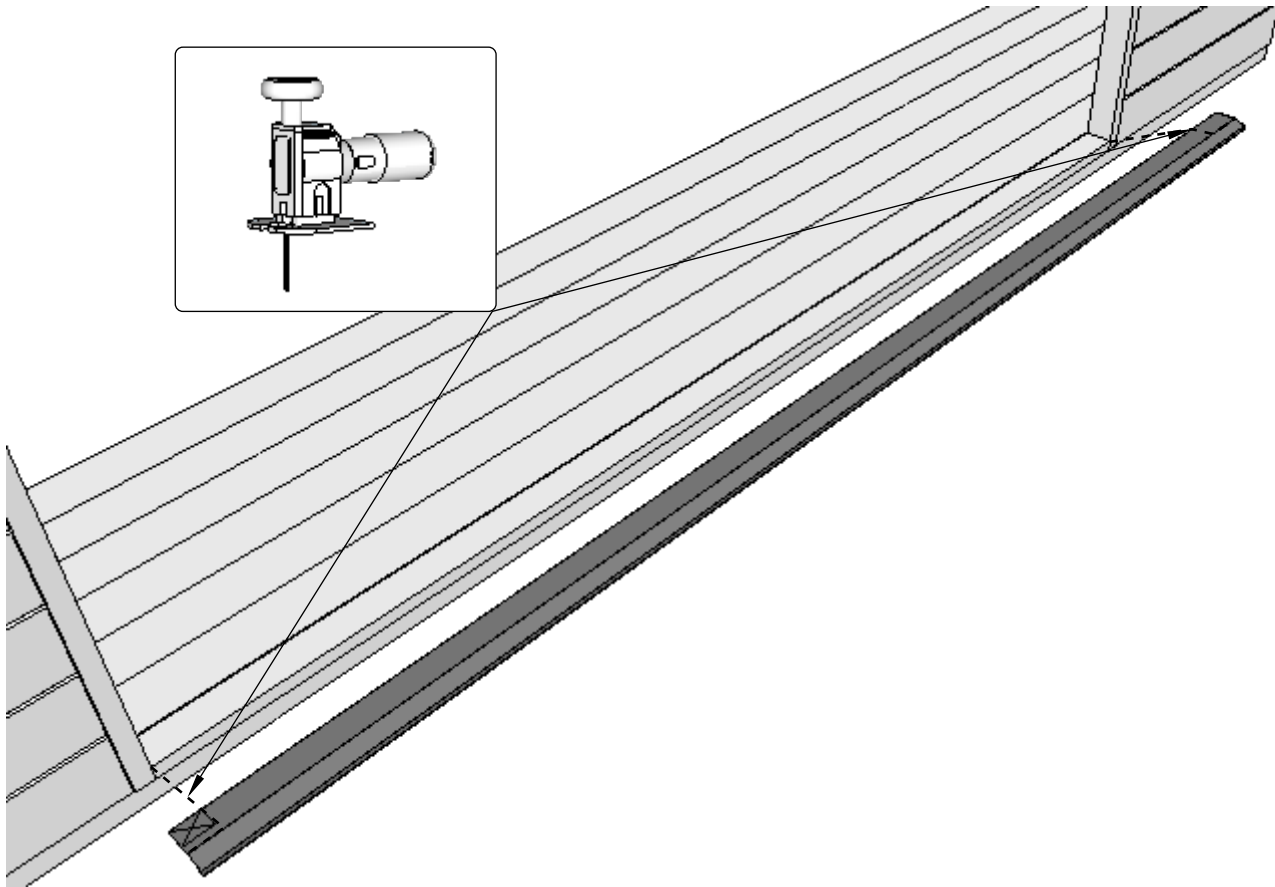
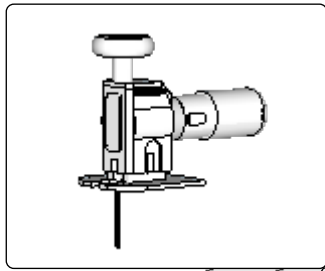

Plan: 15-A LU104-5P-7016

Positions:

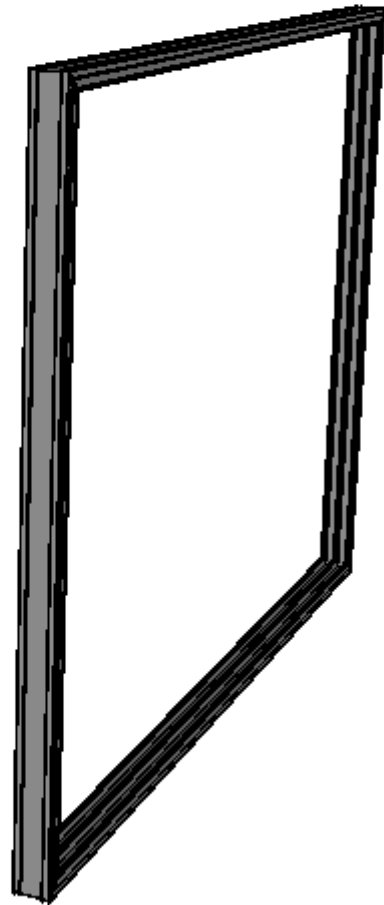
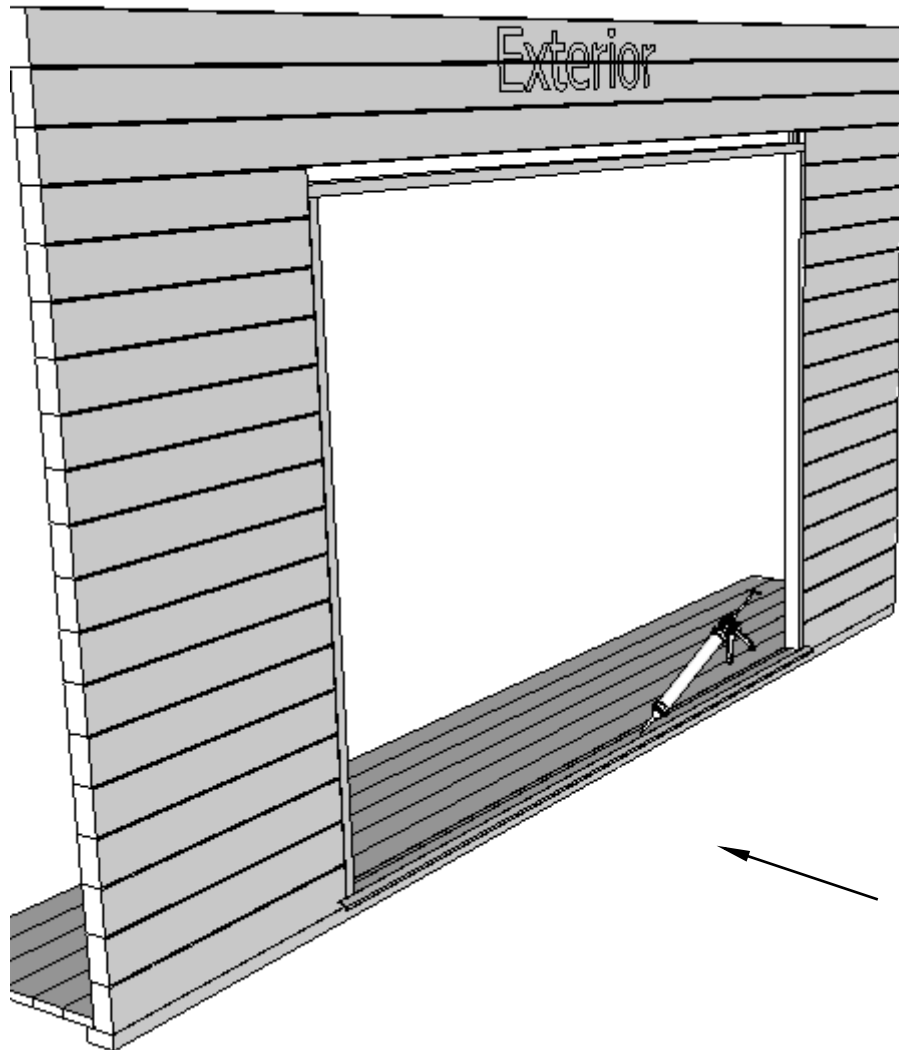

Interior

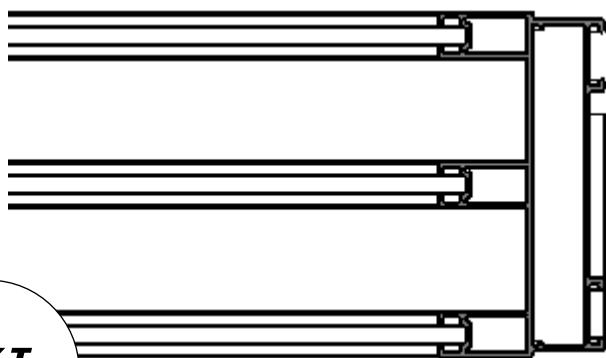

Exterior

*XI*

Plan: 15-A LU104-5P-7016

Positions:

 QKRYP5x60Zn

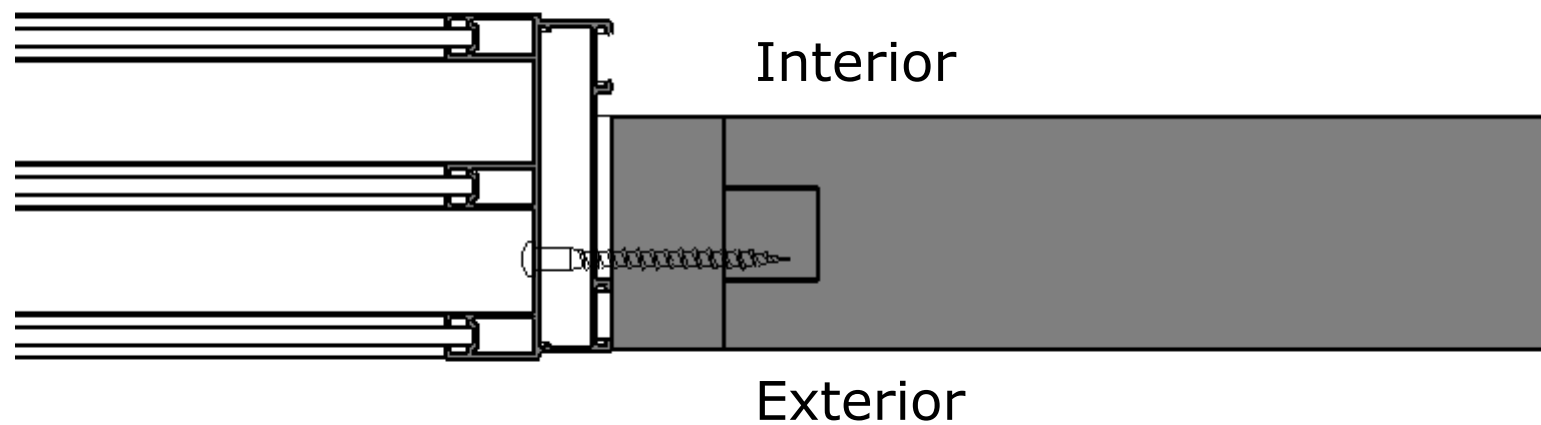
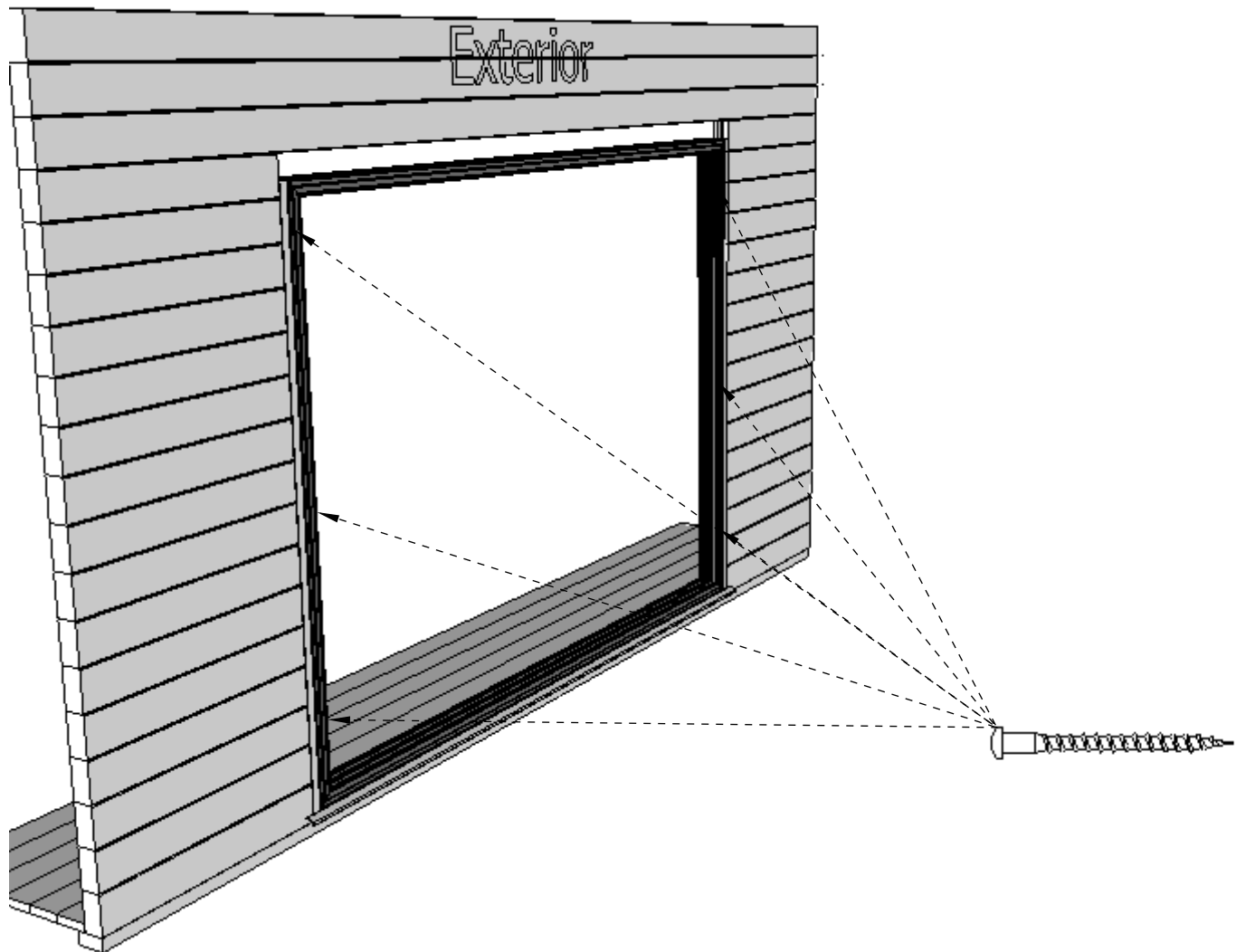

*XII*



Plan: 15-A LU104-5P-7016

Positions:

Sis



QKRYP5x60Zn

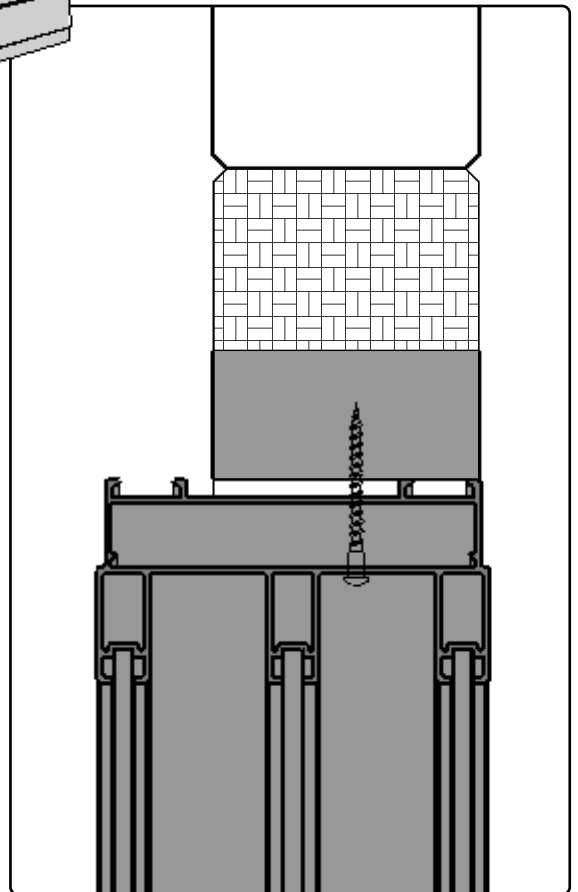
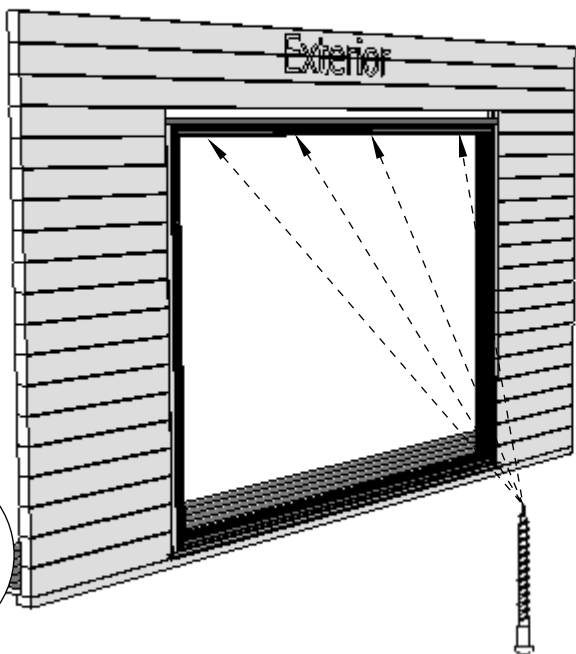
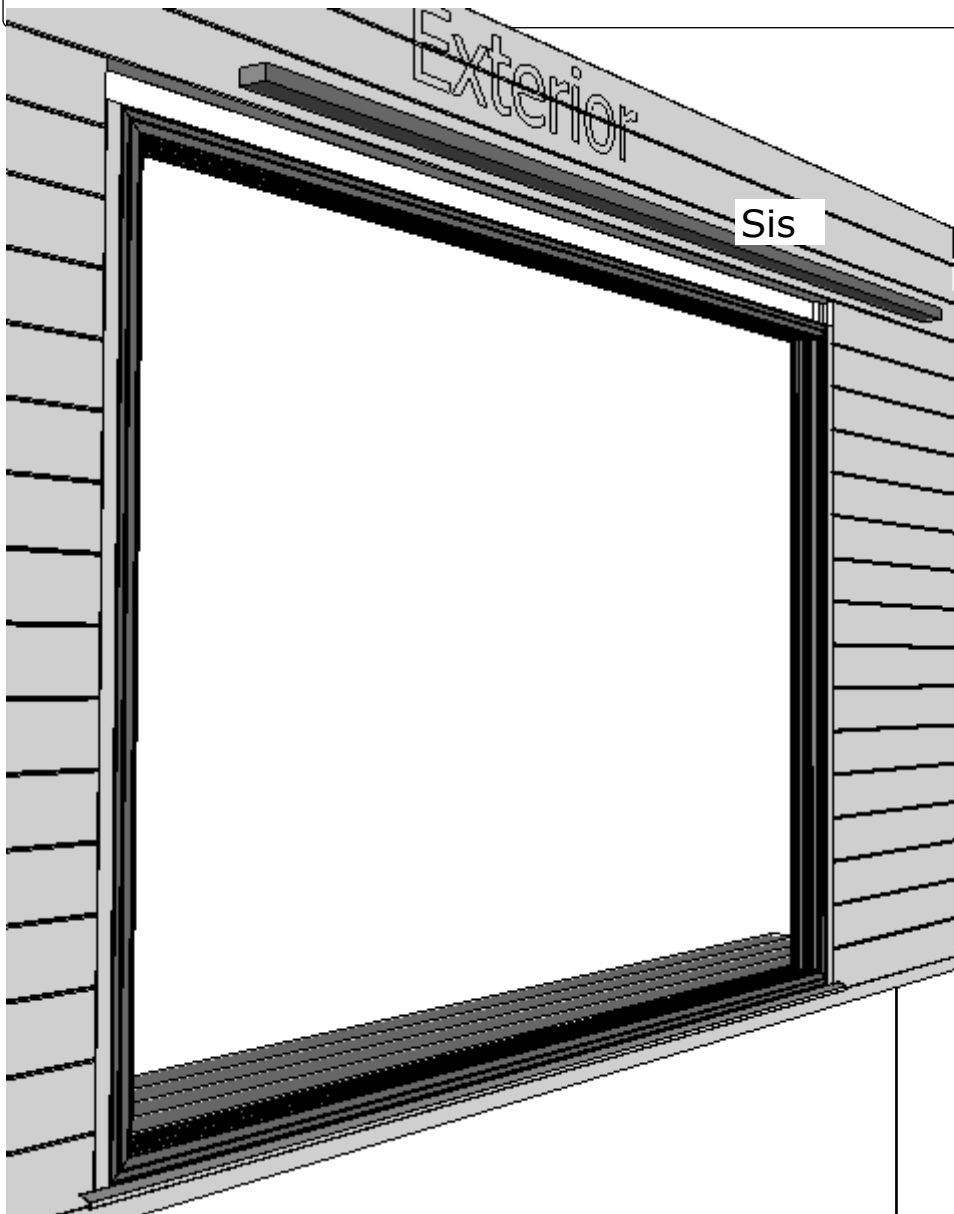

*XIII*

Plan: 15-A LU104-5P-7016

Positions:



QKRYP5x60Zn



QG2

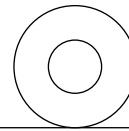

QSE3x8\_5

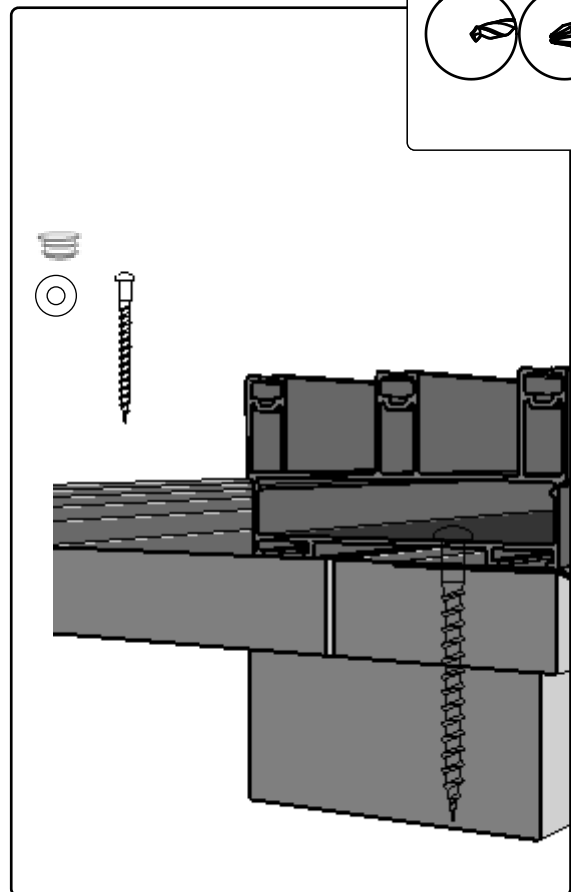
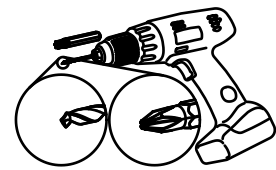
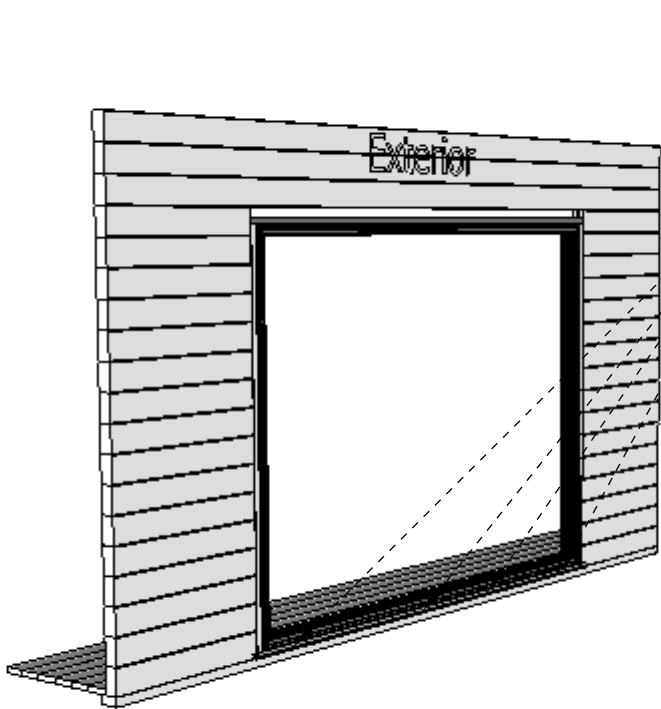

XIV

Plan: 15-A LU104-5P-7016

Positions:

QT140-1

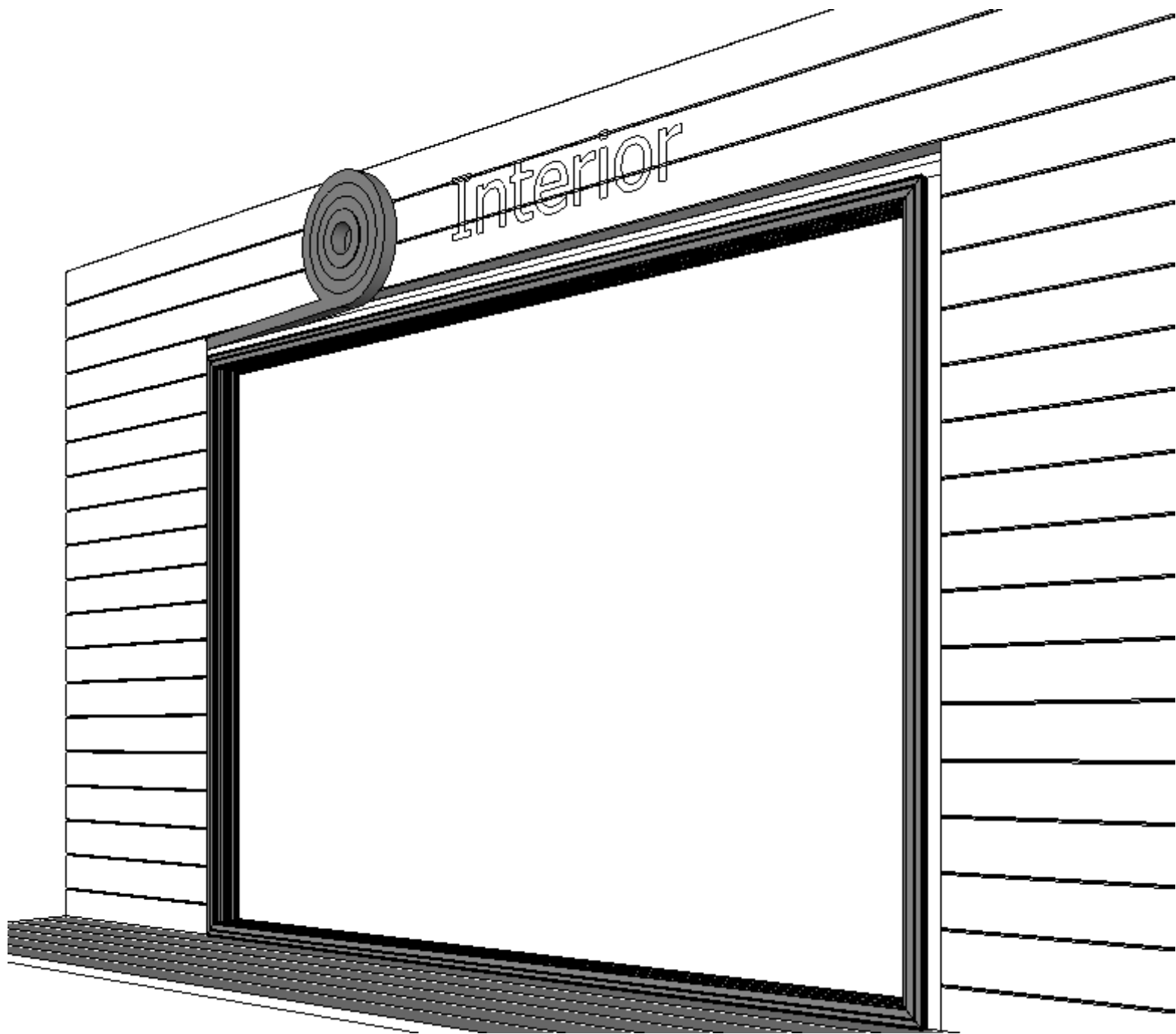

XV

Plan: 15-A LU104-5P-7016

Positions:

COB

QKRPP3-5x50Zn

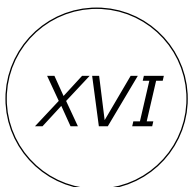
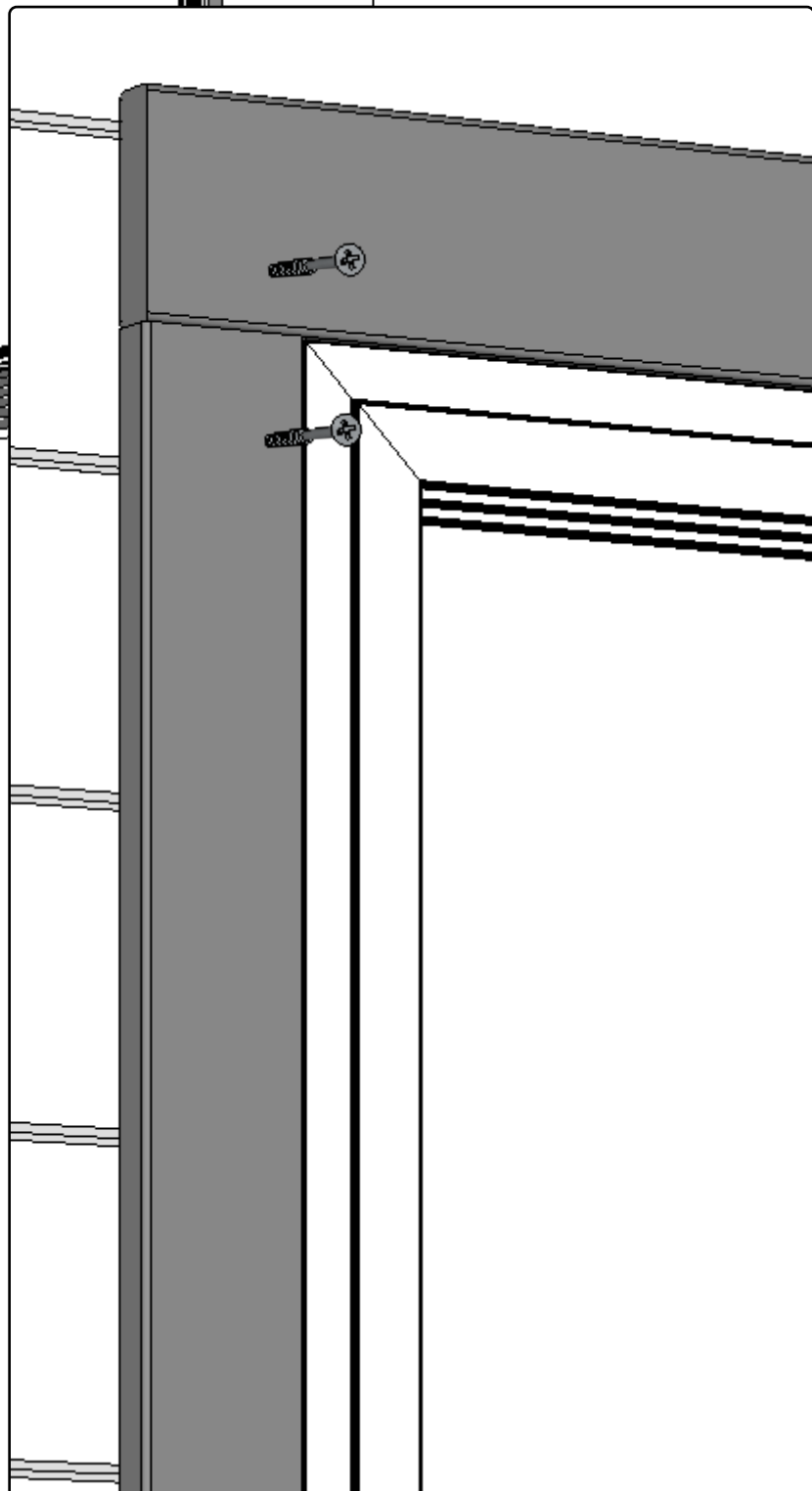
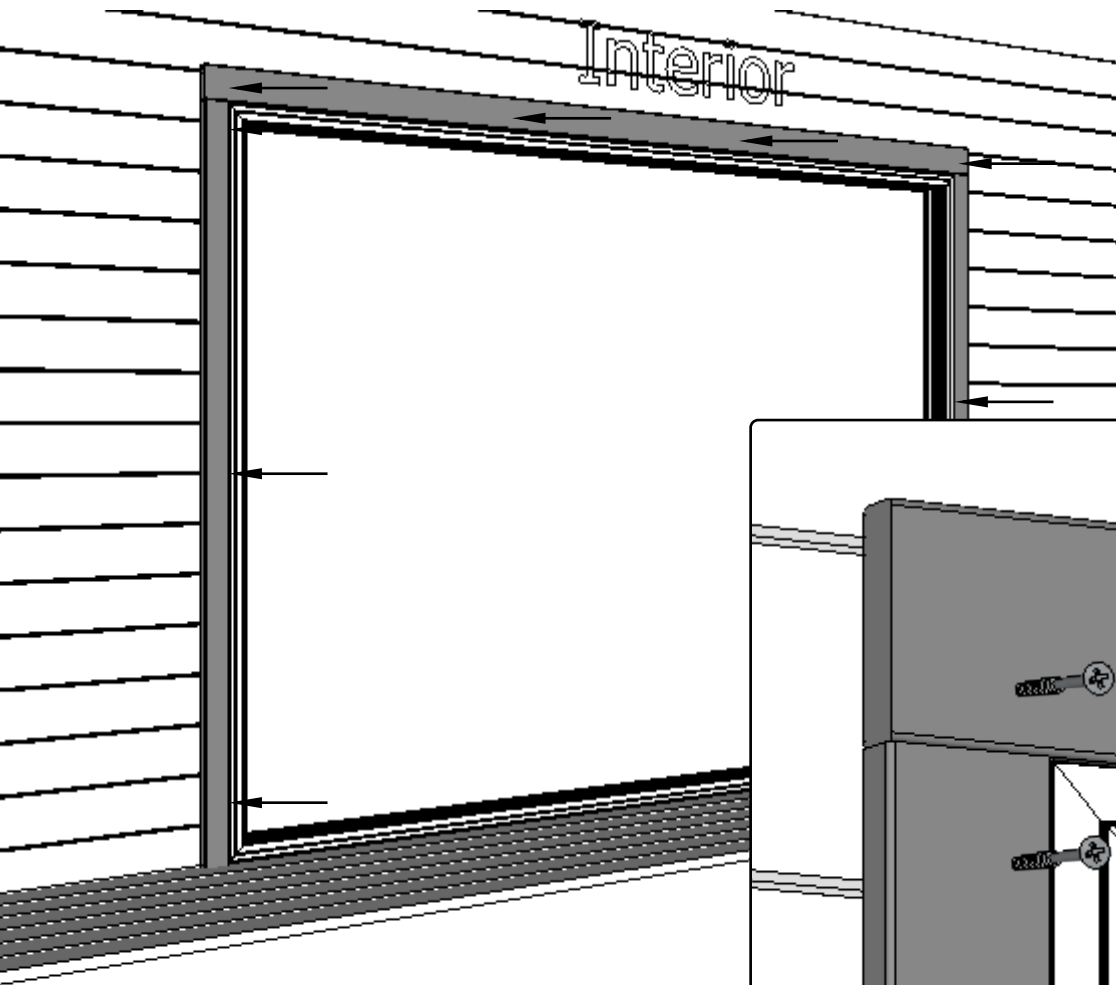

Plan: 15-A LU104-5P-7016

Positions:

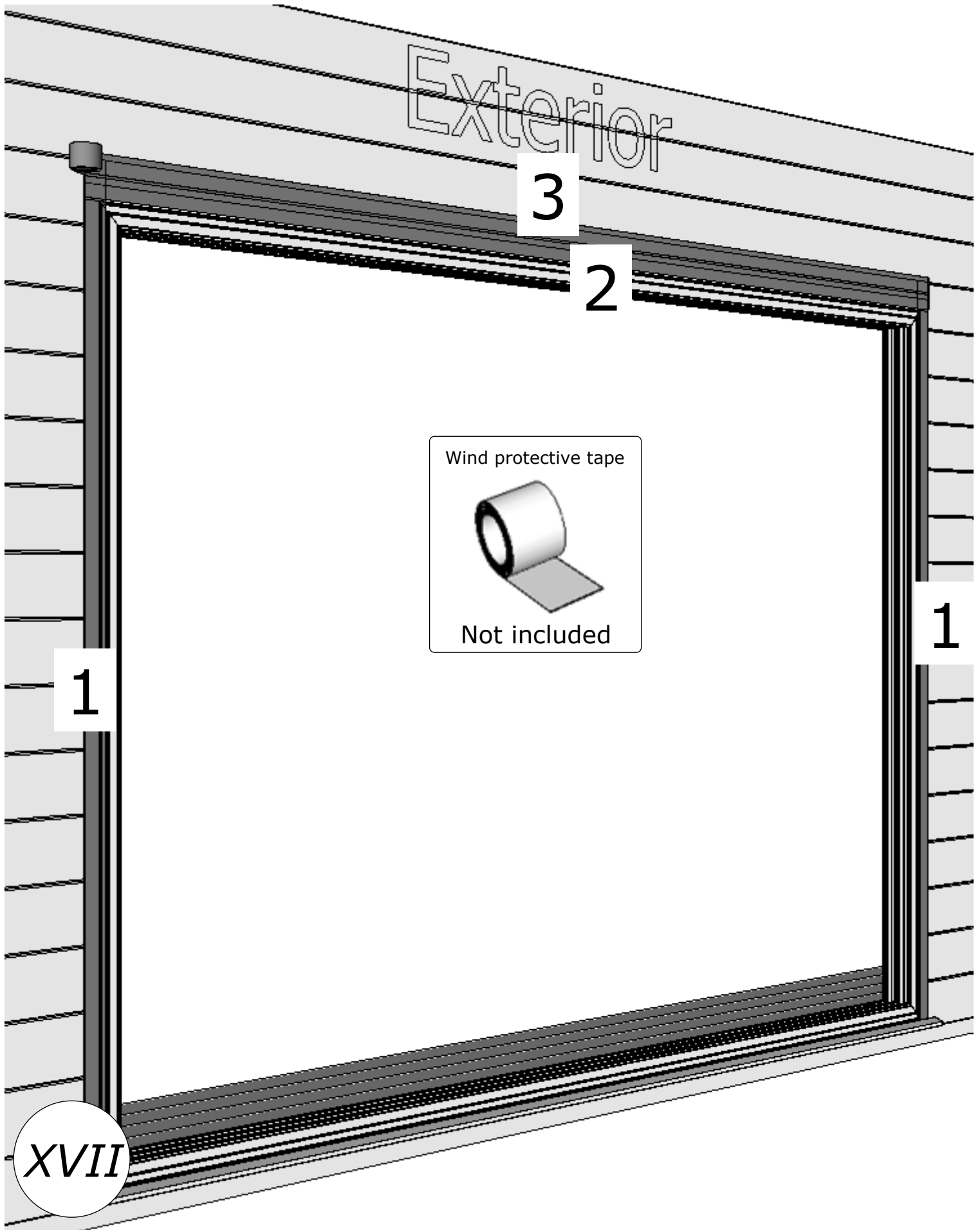

Plan: 15-A LU104-5P-7016

Positions:

COB

QKRPP3-5x50Zn

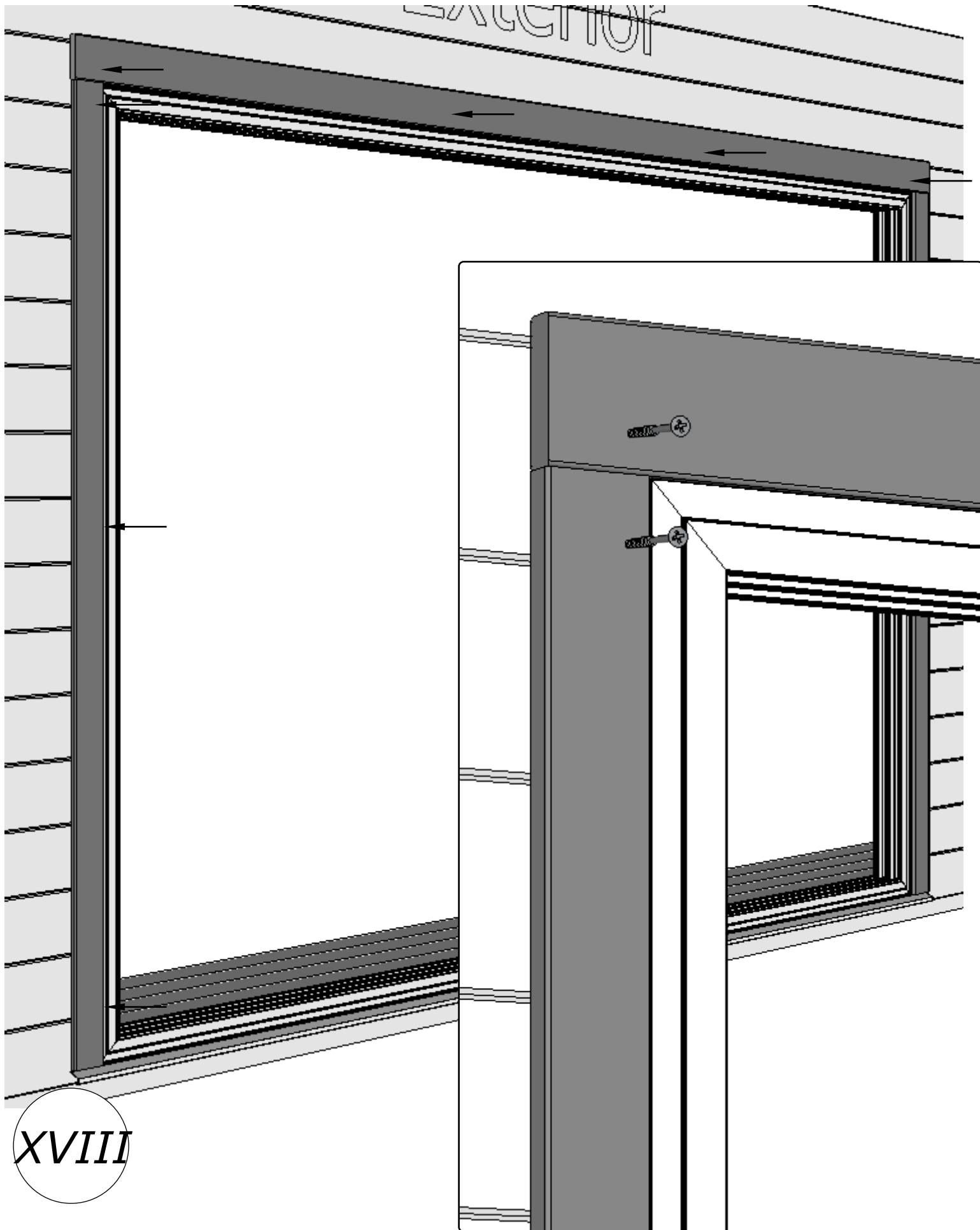

XVIII

Plan: 15-A LU104-5P-7016

Positions:

COB



QKRPP3-5x50Zn

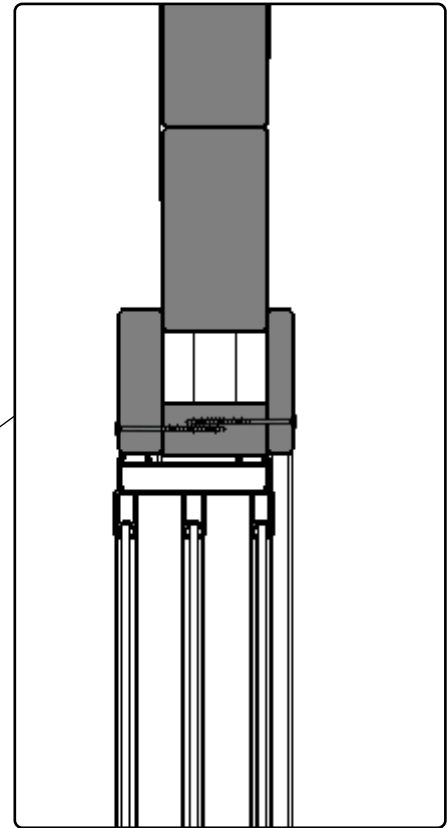
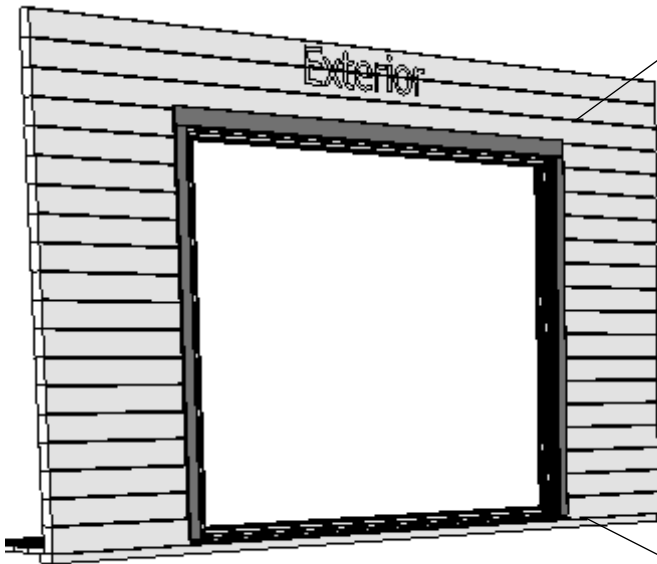

Interior

Exterior

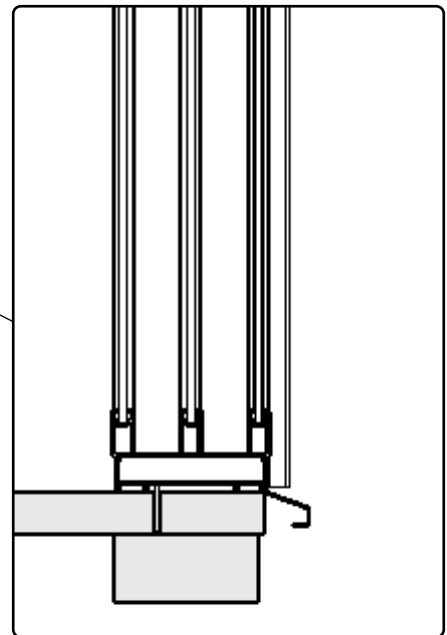

Plan: 15-A LU104-5P-7016

Positions:

COB



QKRPP3-5x50Zn

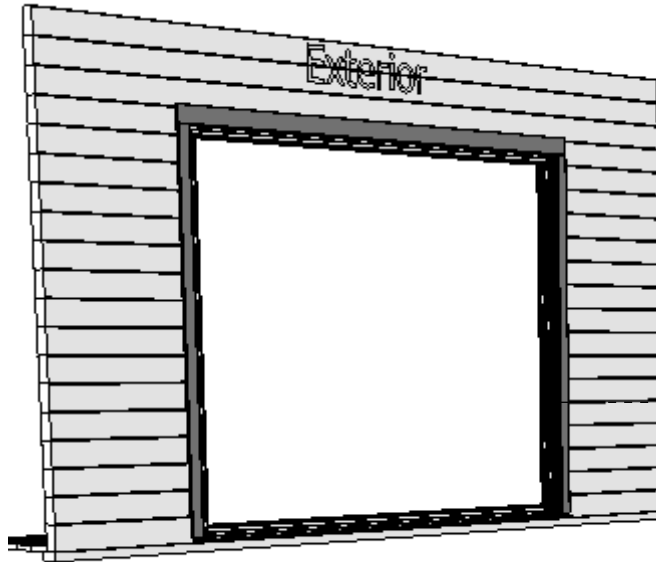

Interior

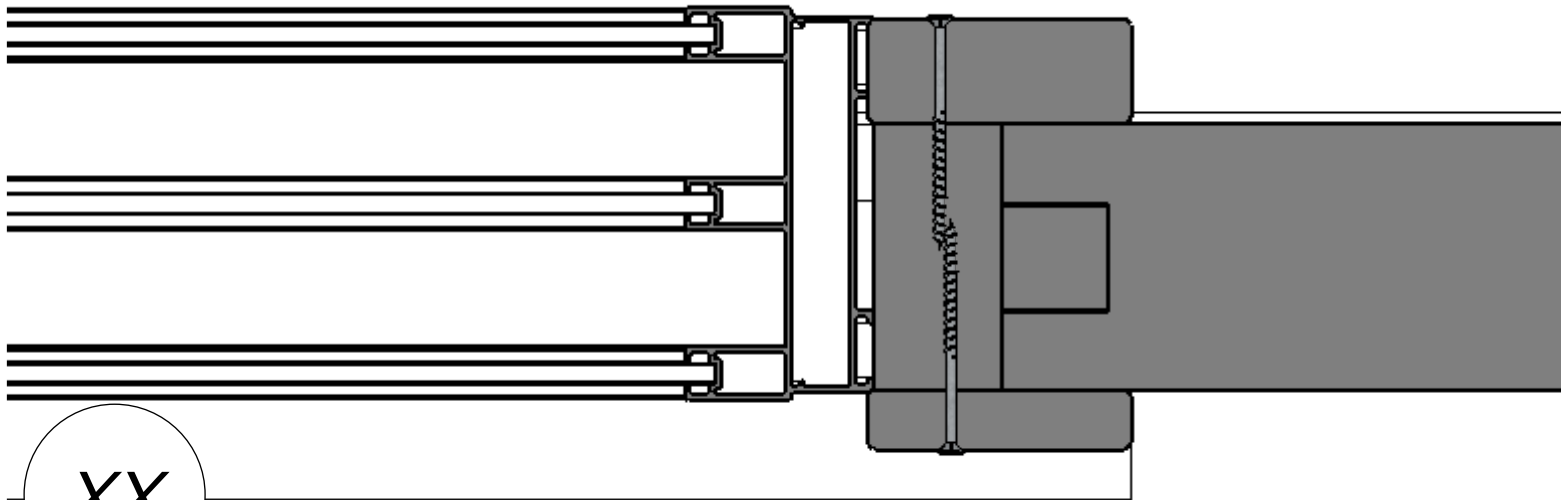

XX

Exterior



Plan: 15-A LU104-5P-7016

Positions:

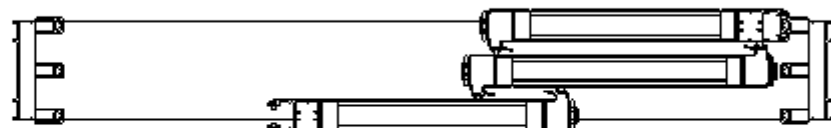
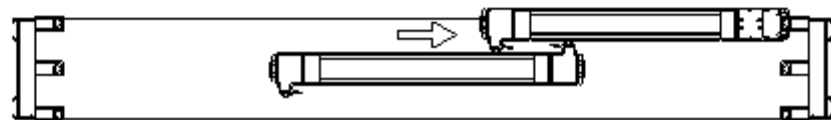
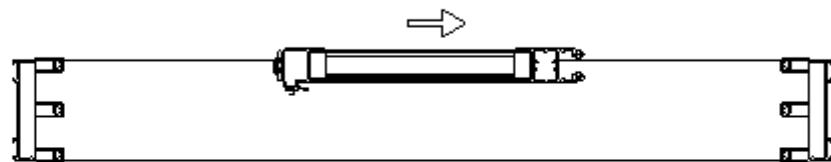
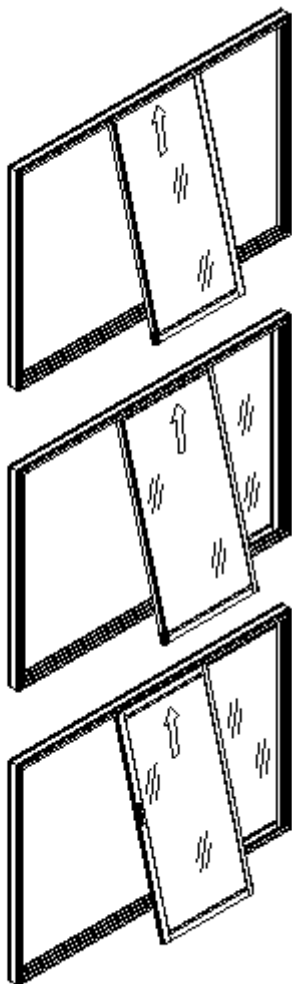
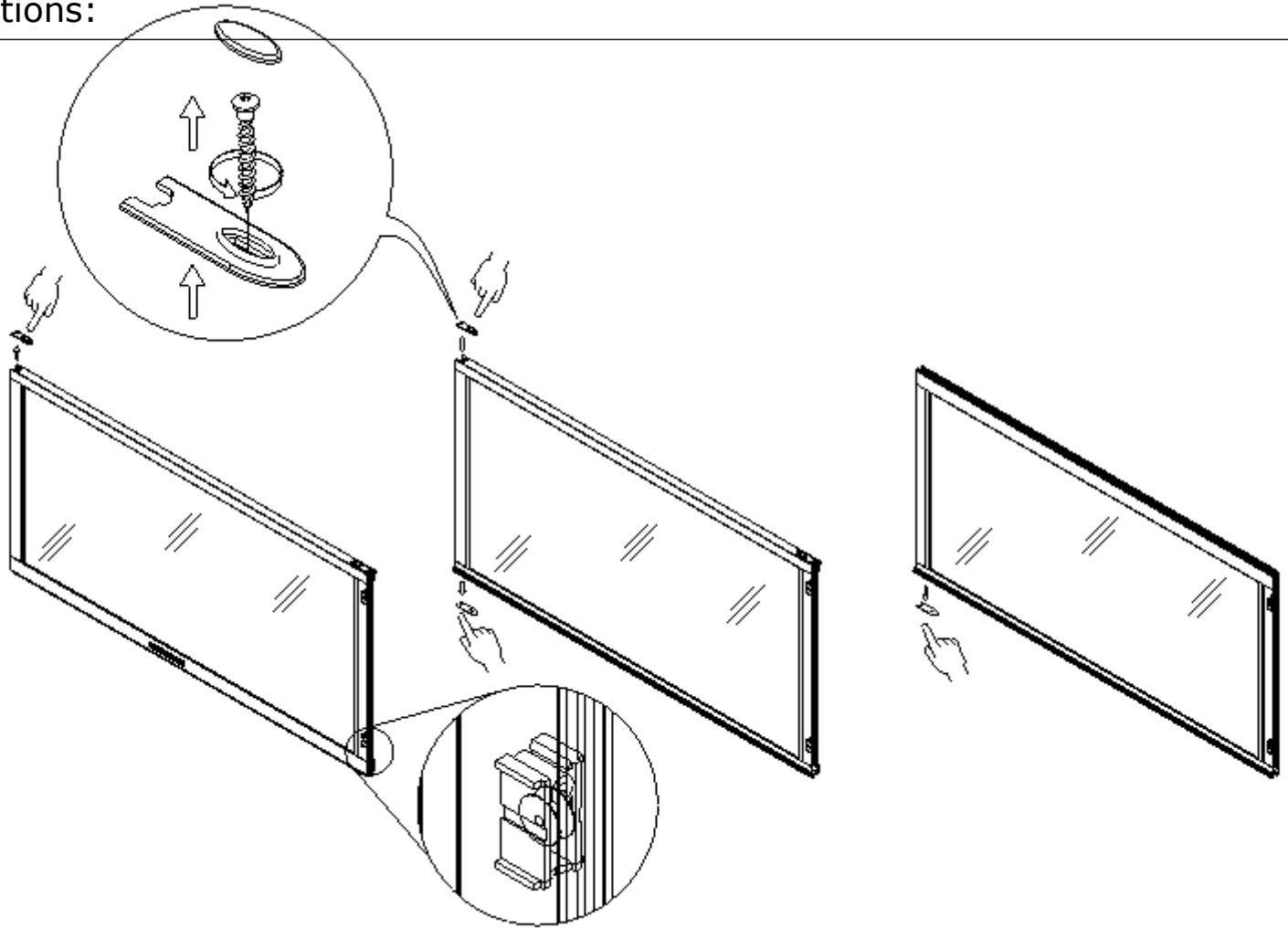

XXI

Plan: 15-A LU104-5P-7016

Positions:

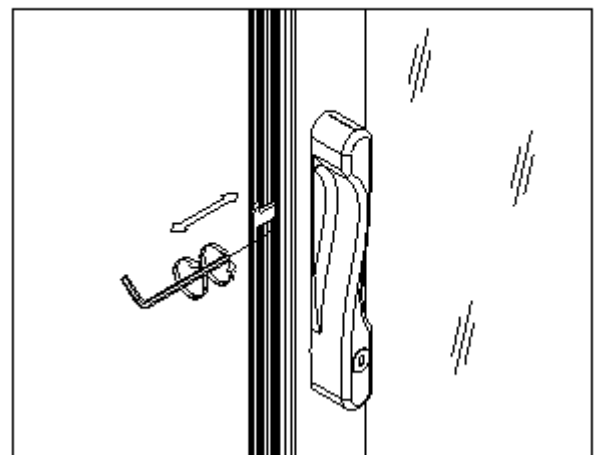
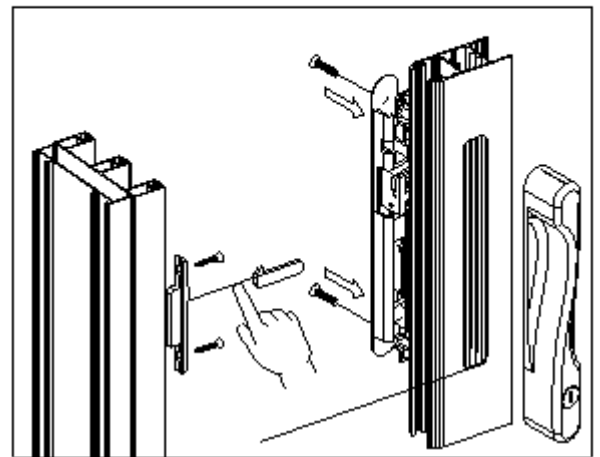
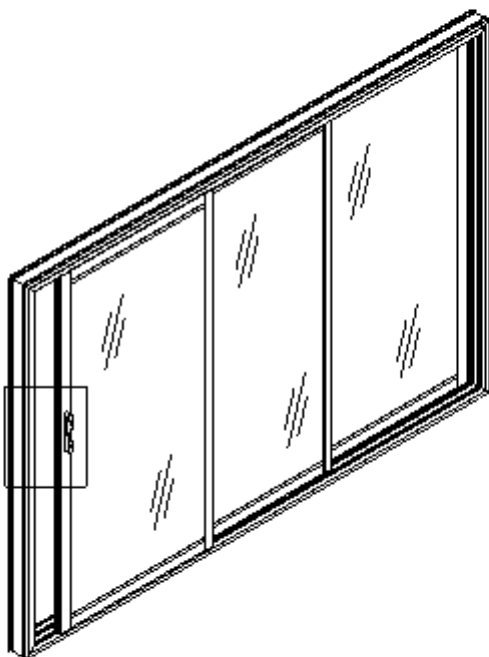
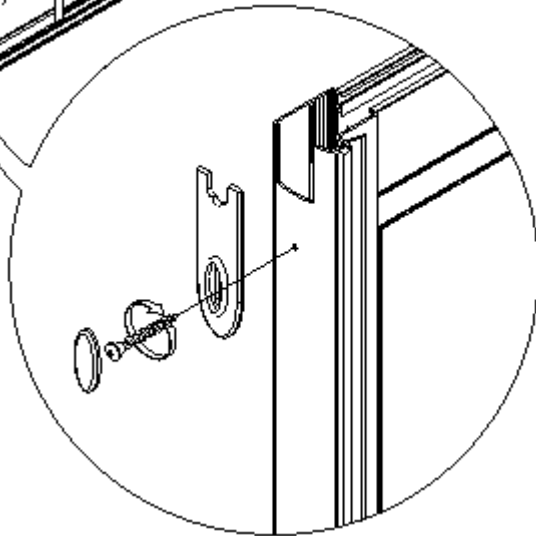
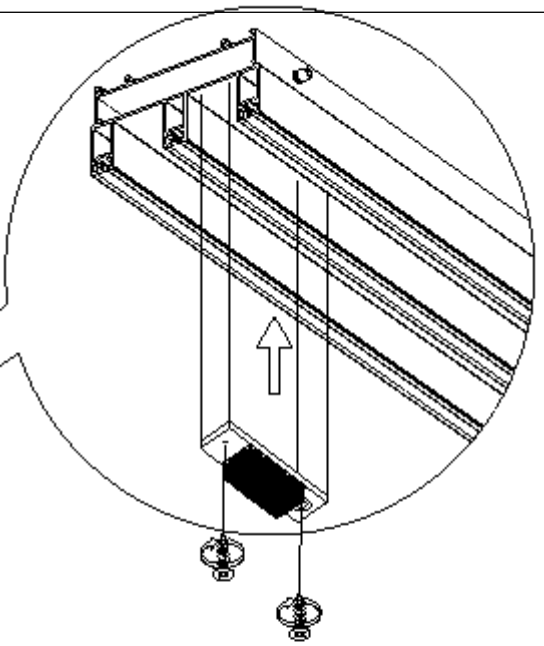
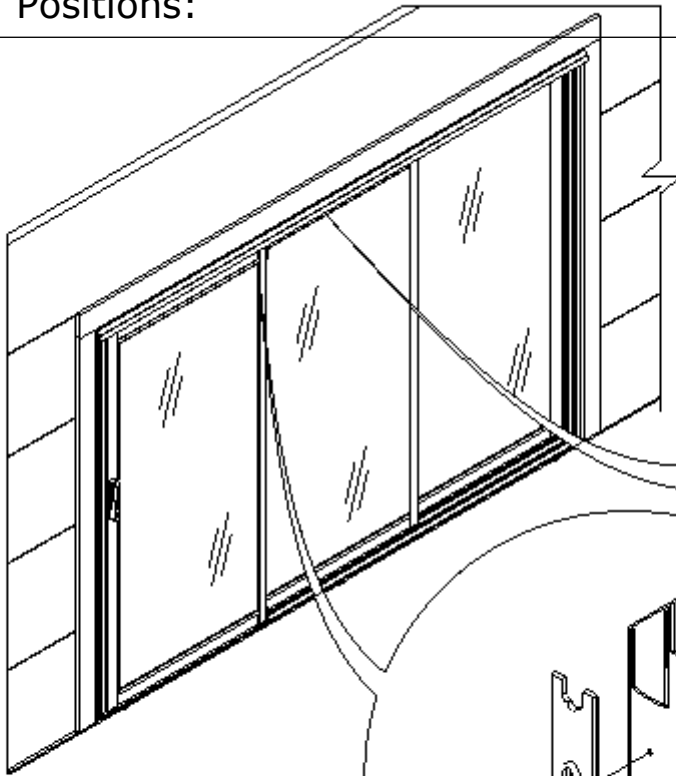

*XXII*

Plan: 15-A LU104-5P-7016

Positions:

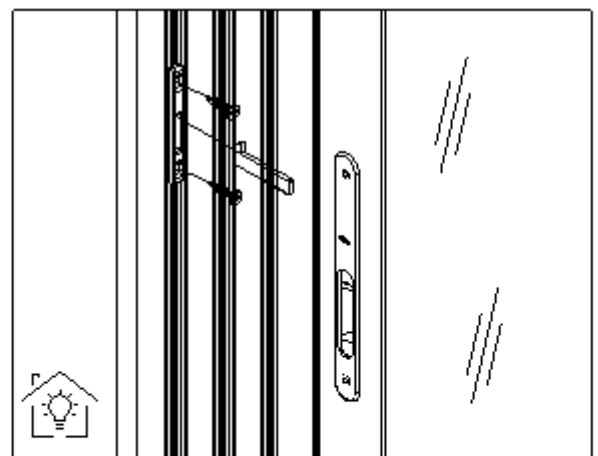
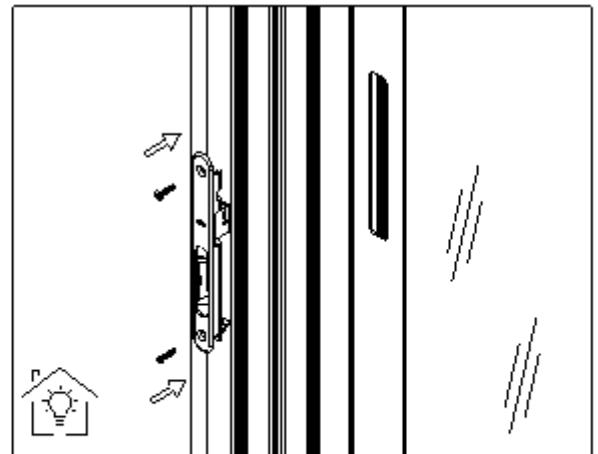
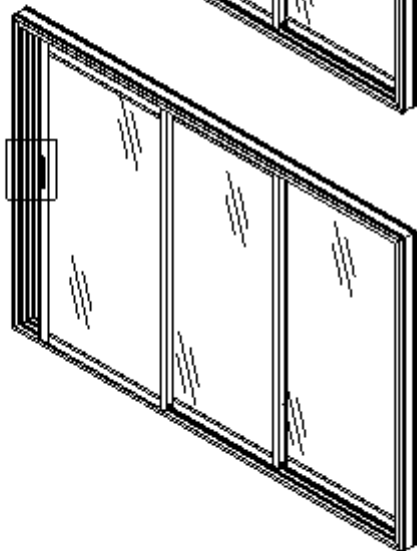
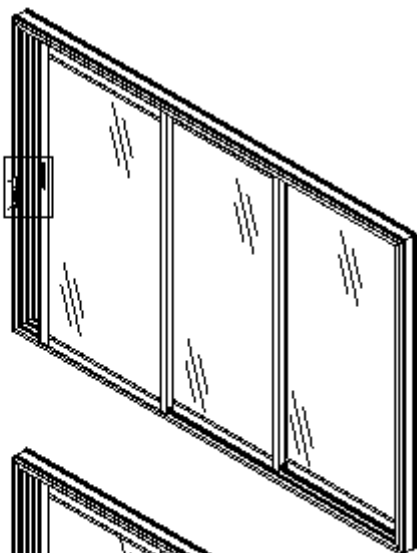
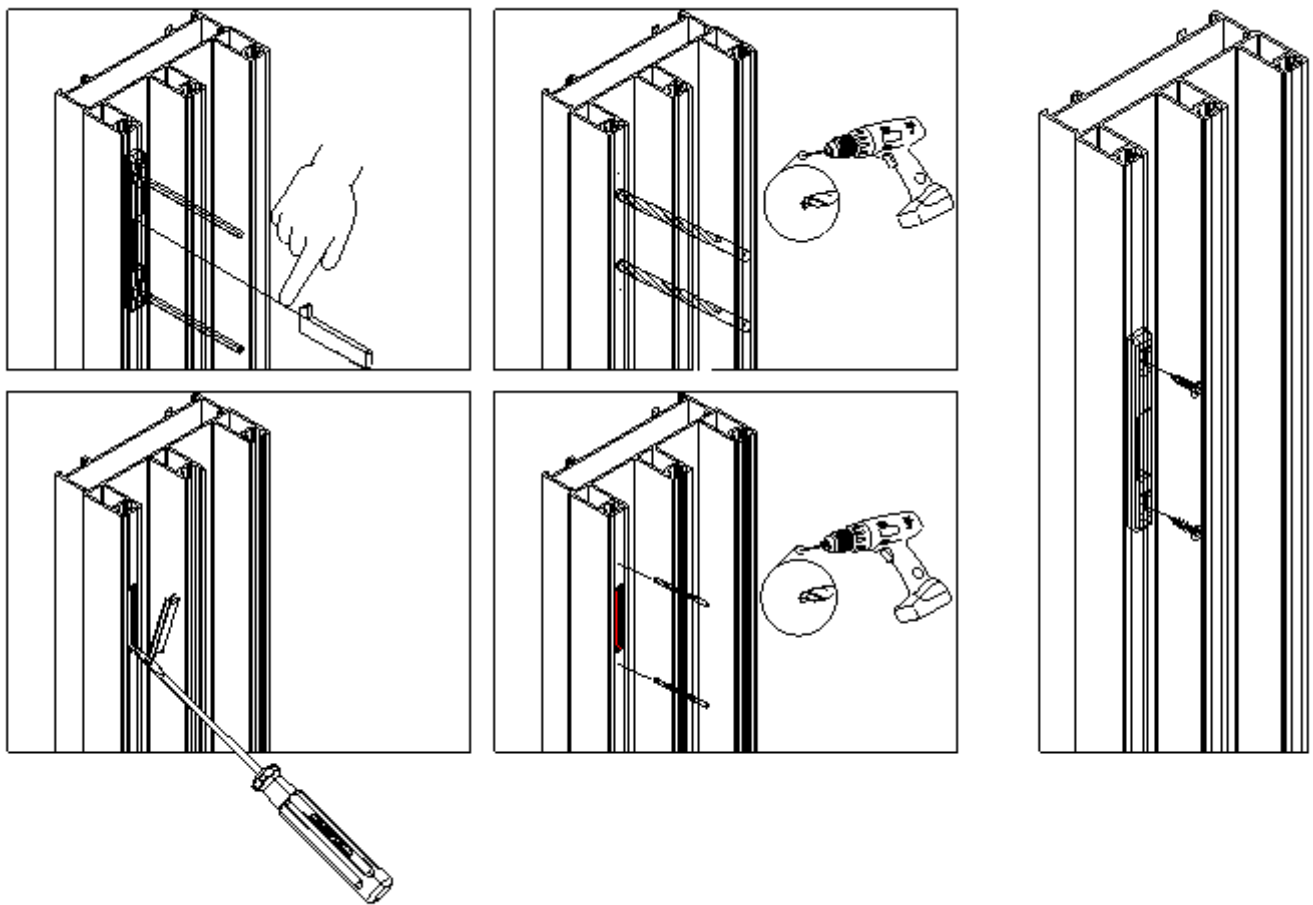

Plan: 15-A LU104-5P-7016

Positions:

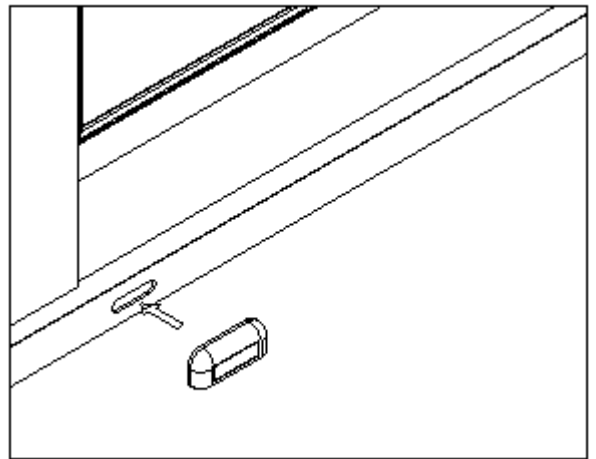
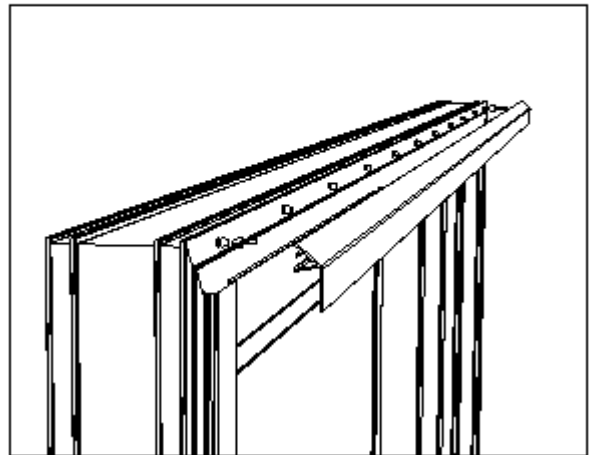
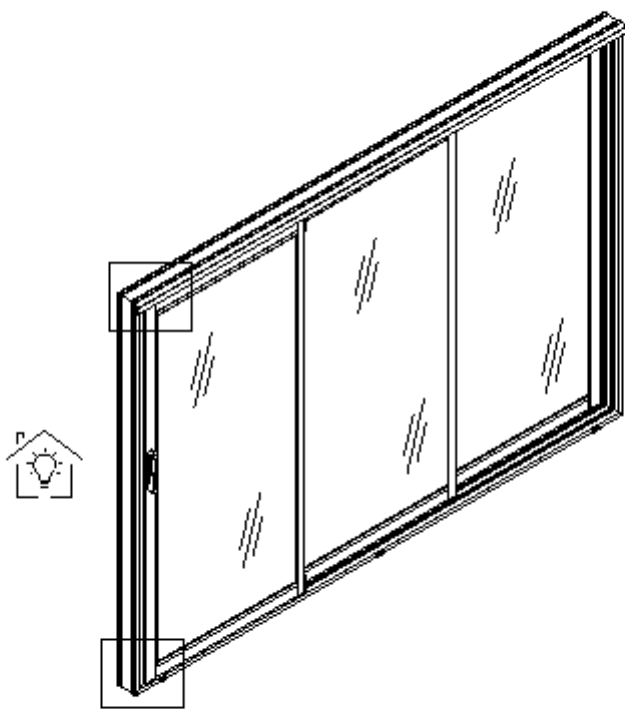

Plan: 14  
Positions: TU51

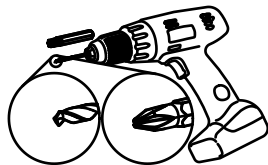
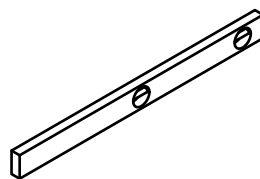
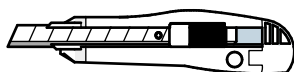
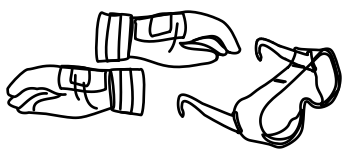
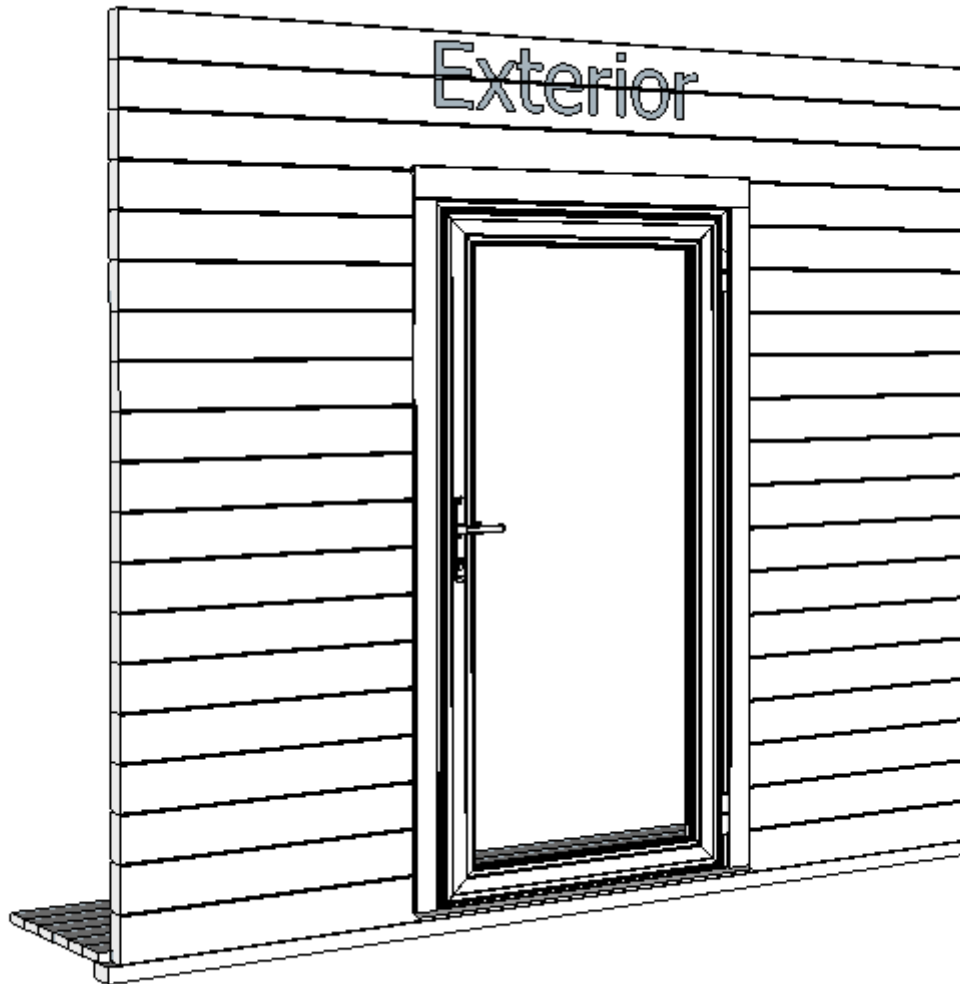

I

Plan: 14  
Positions: TP, Sis



QKRPP3-5x50Zn

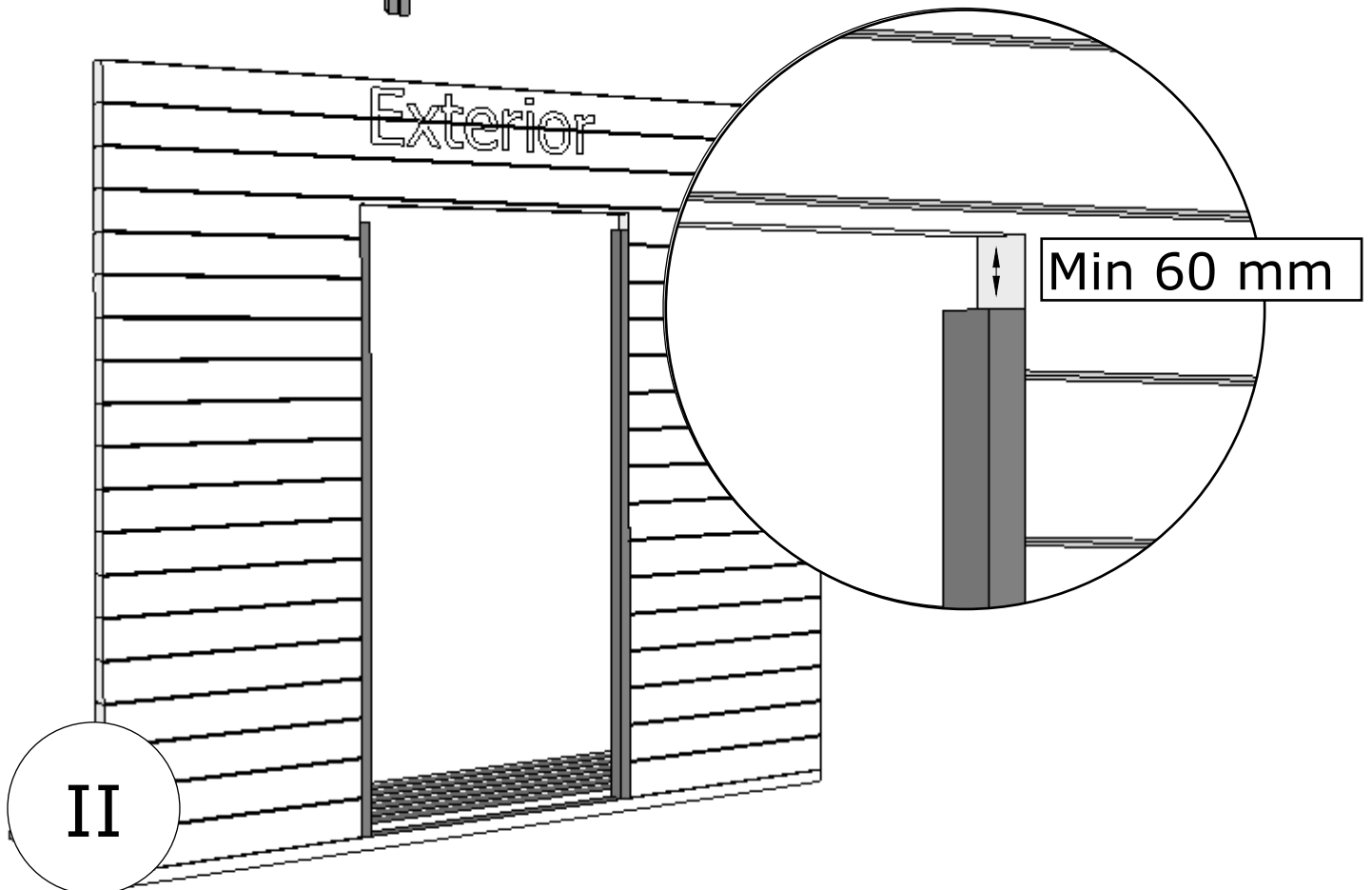
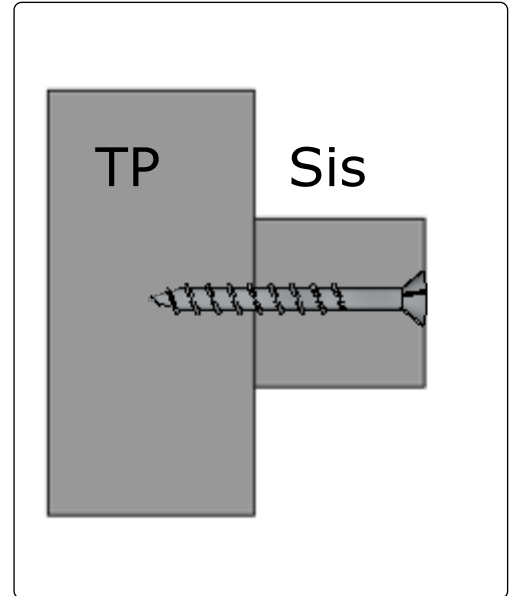
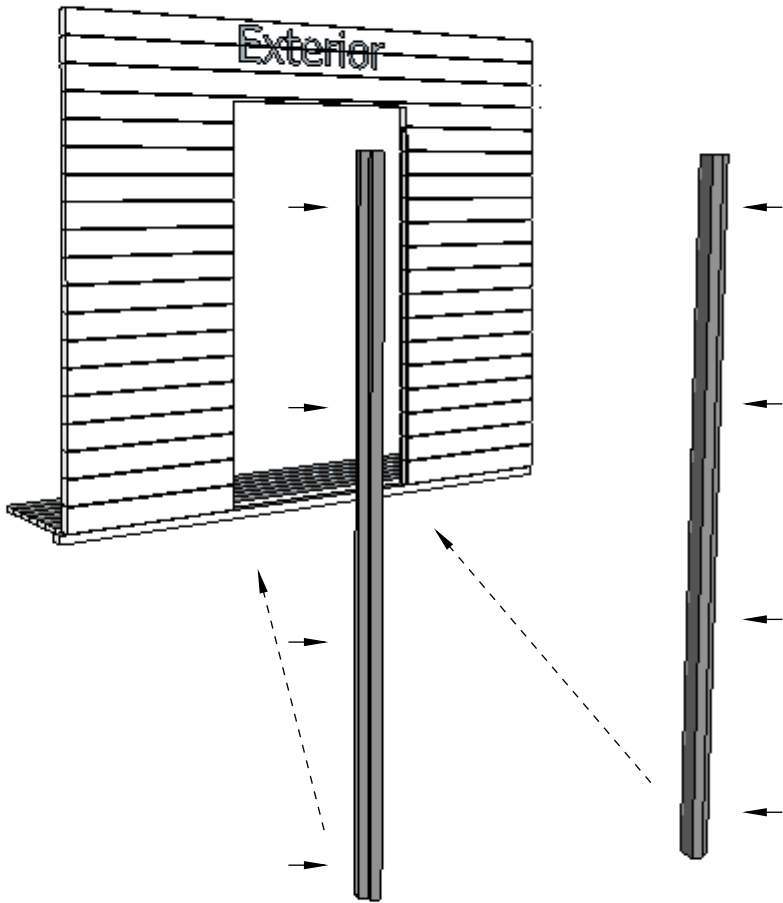

Plan: 14  
Positions: Sla



QKRPP3-5x50Zn

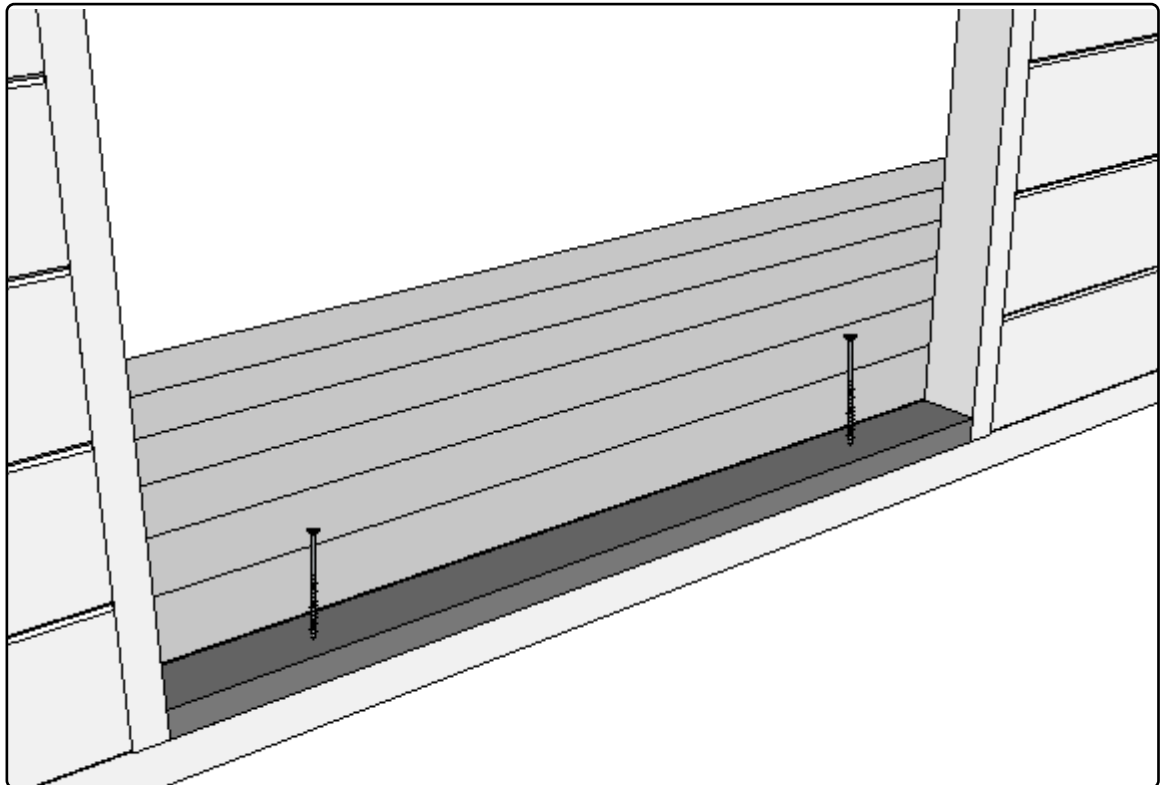
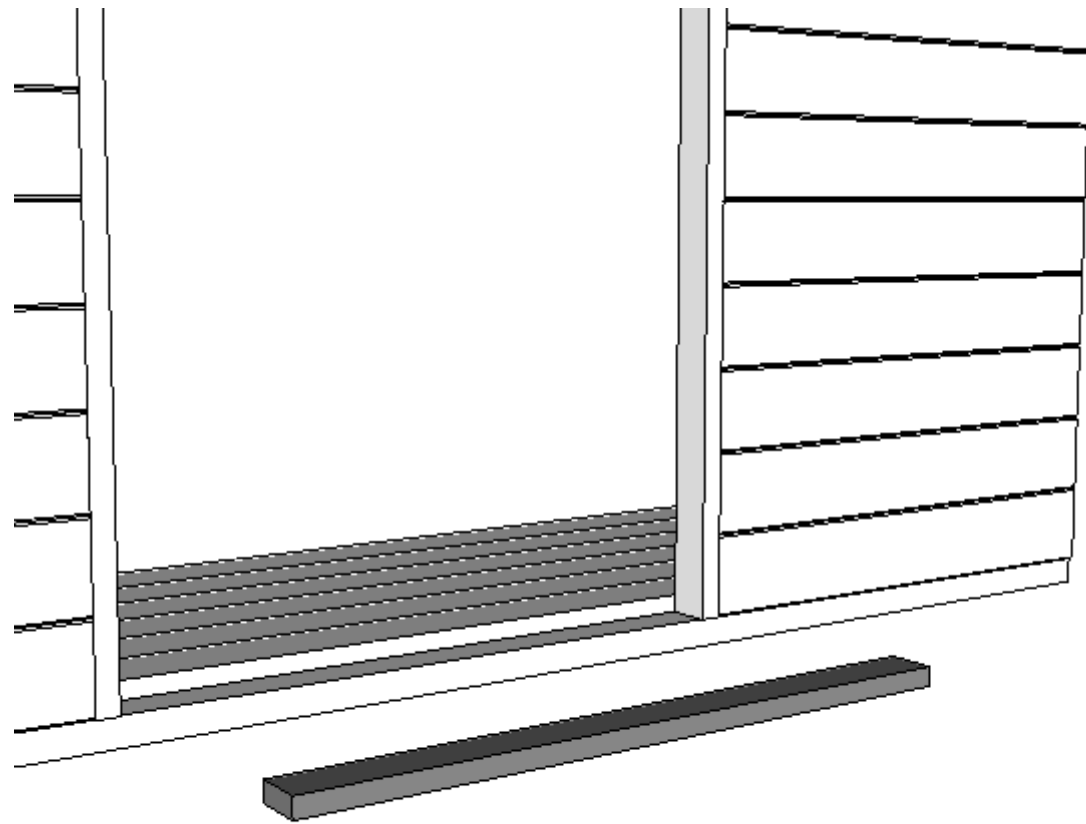

III

Plan: 14  
Positions: QP40x30x1109MU

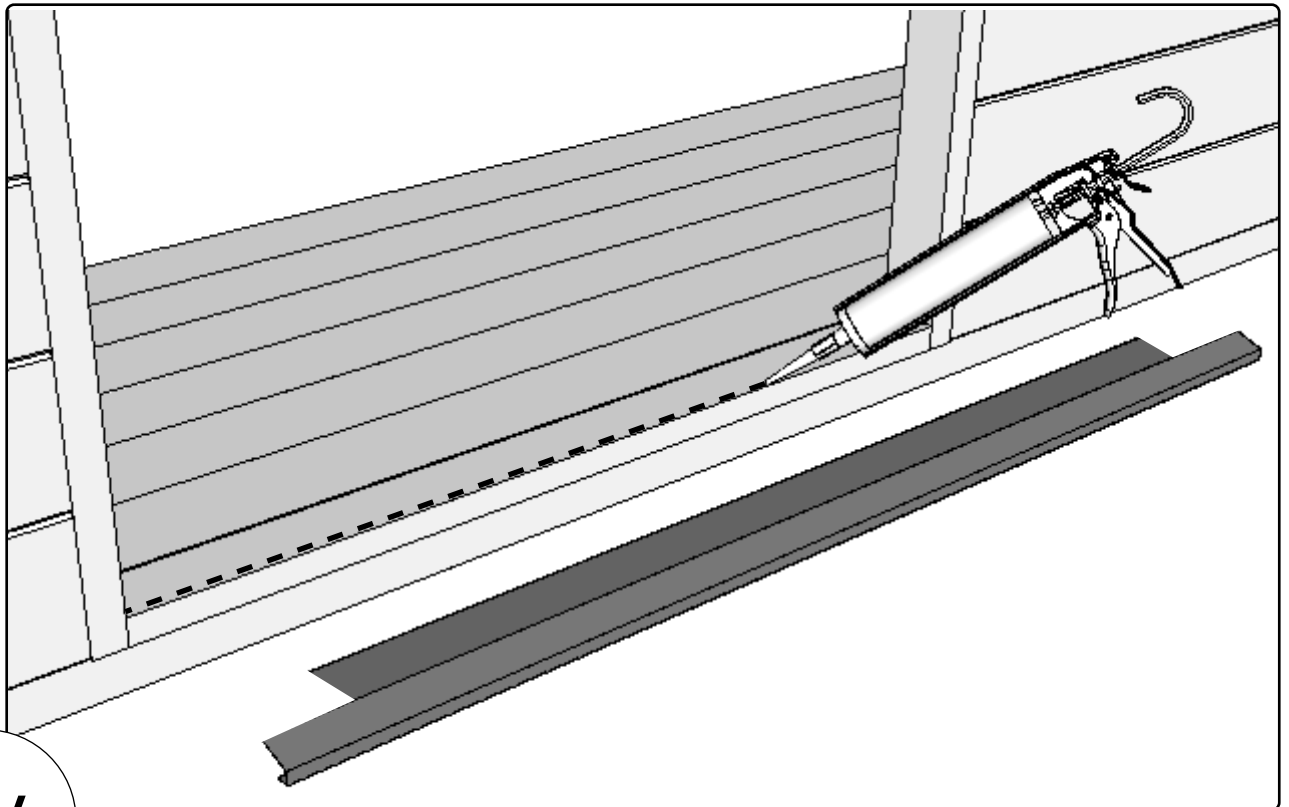
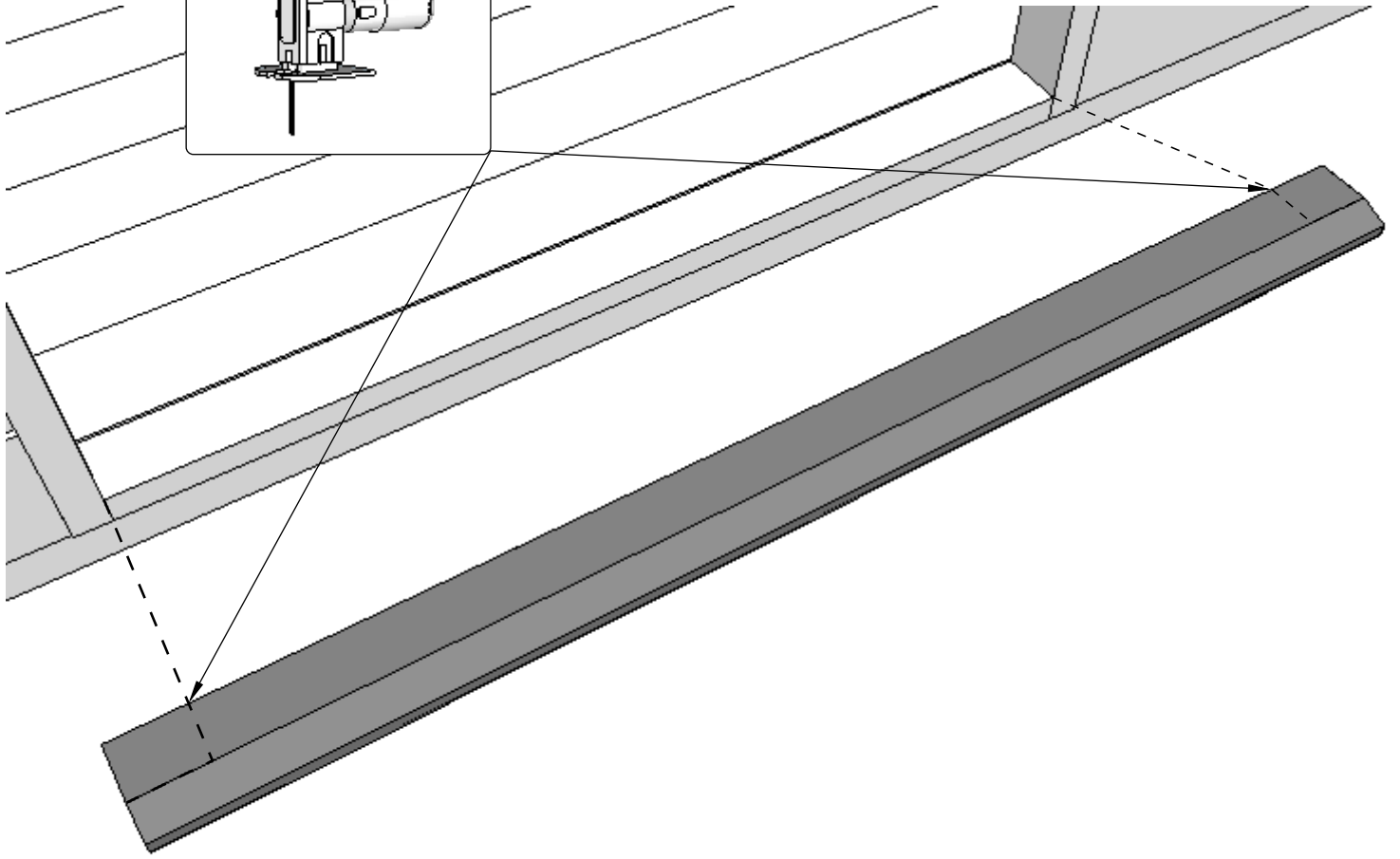
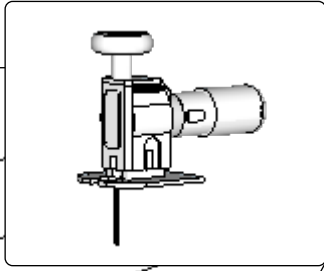

IV



Plan: 14  
Positions:

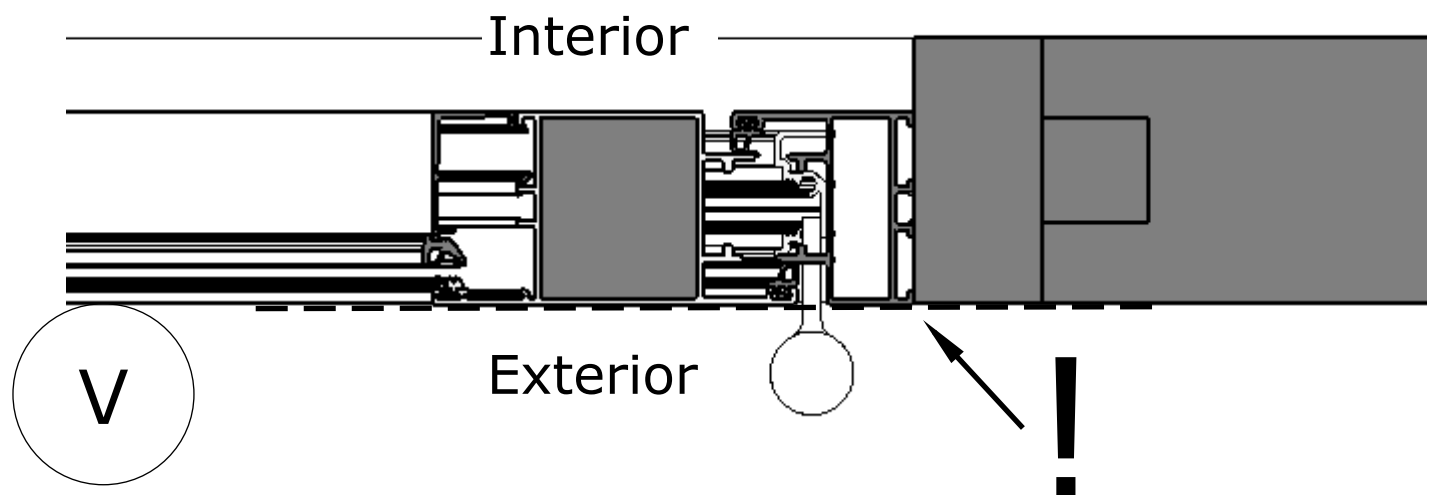
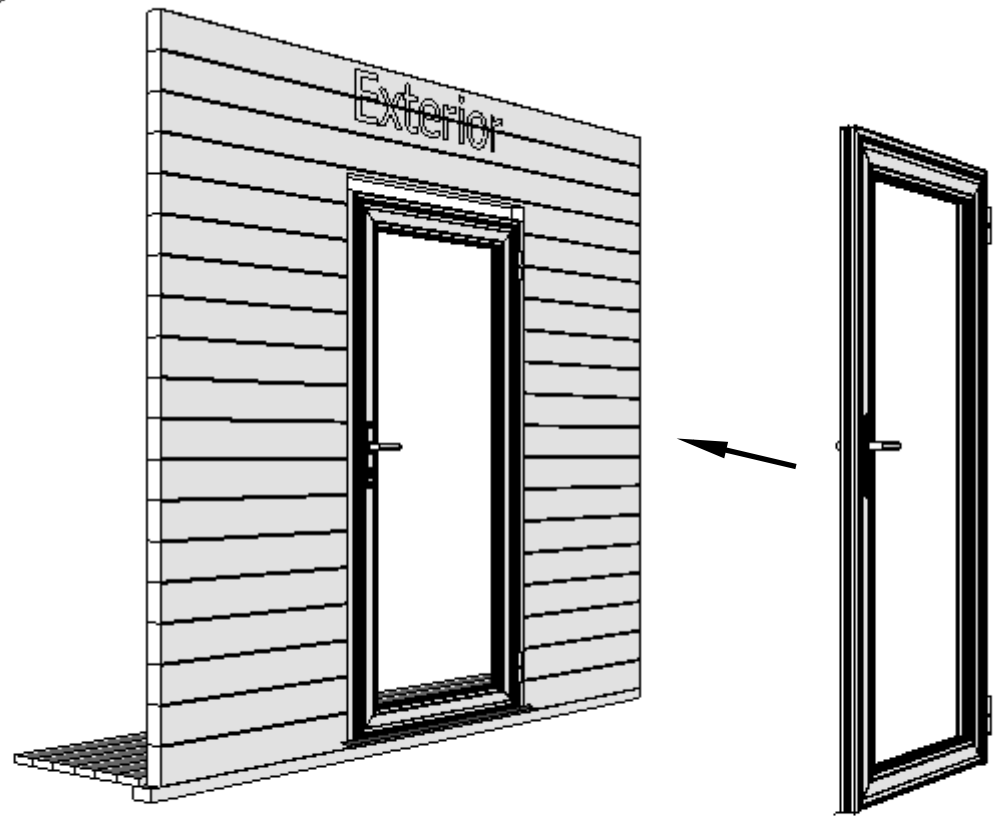
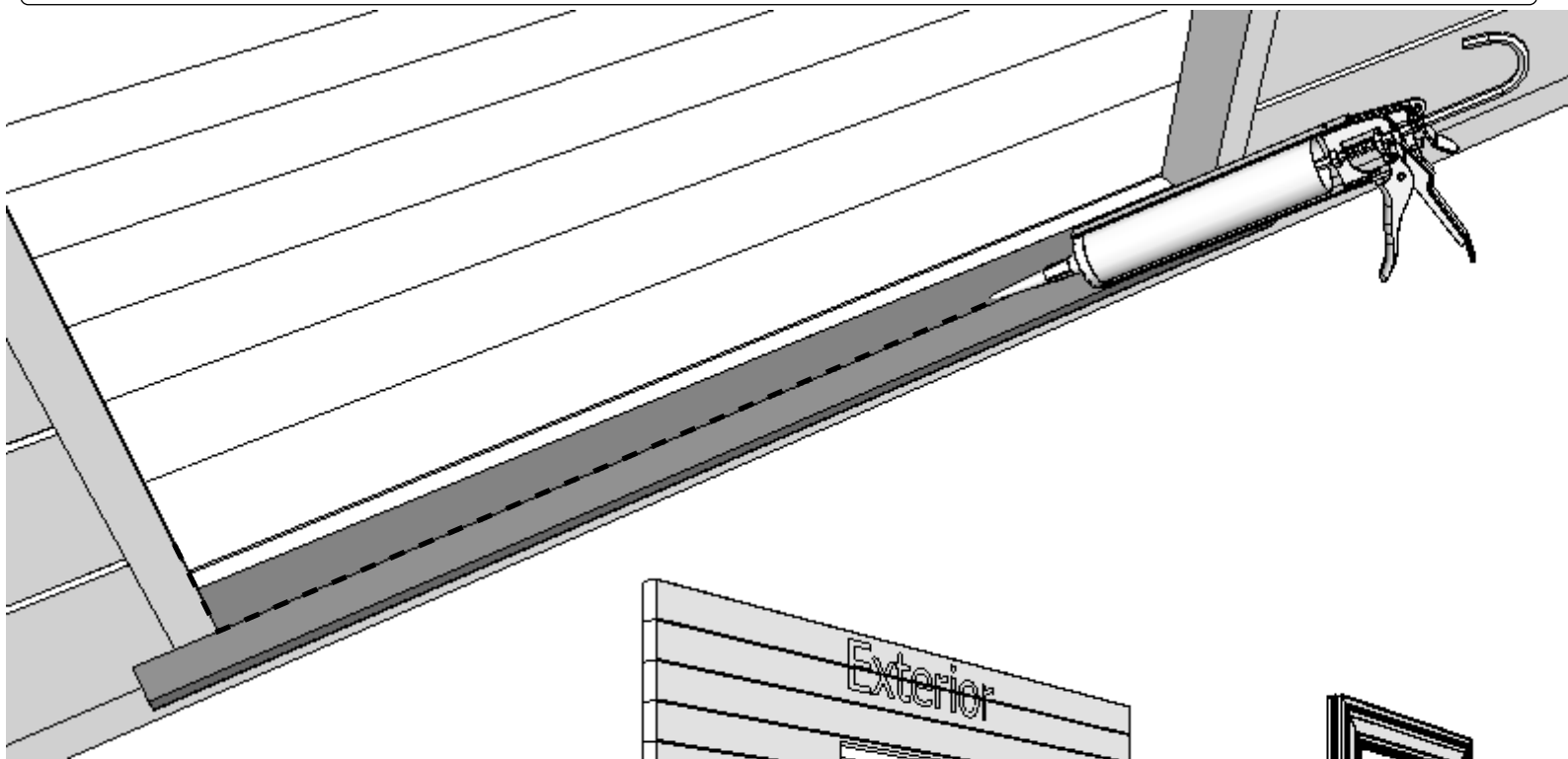

Plan: 14  
Positions: QLY-ACWKS92  
QLY-LWB02

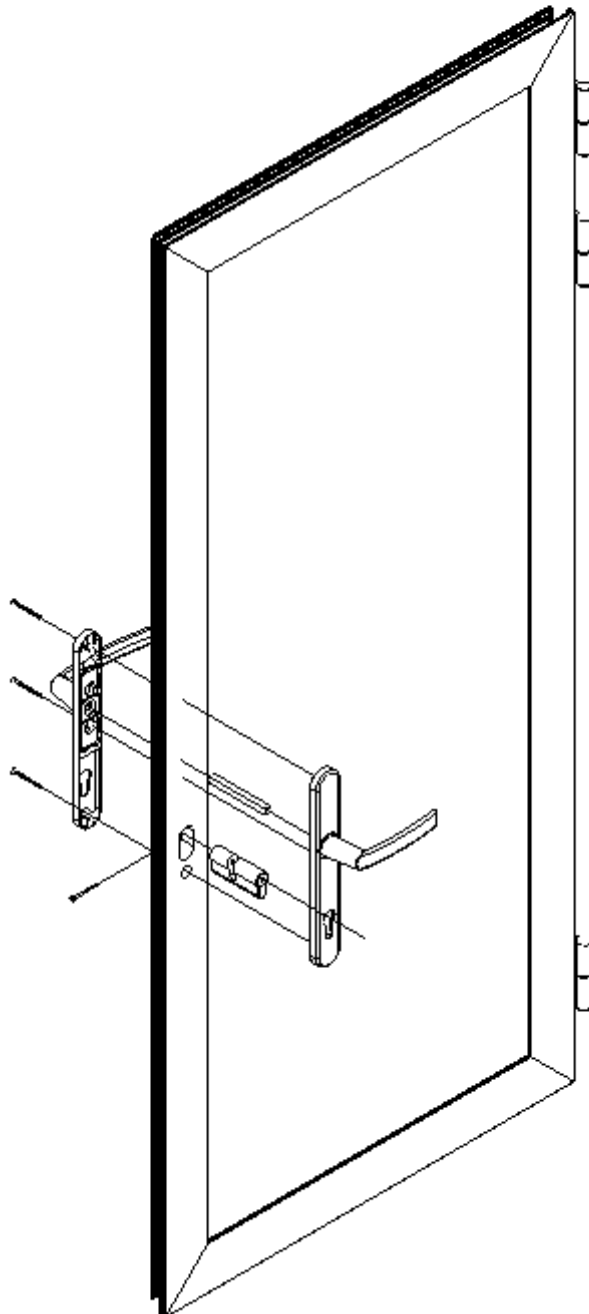
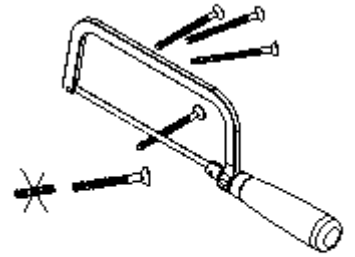
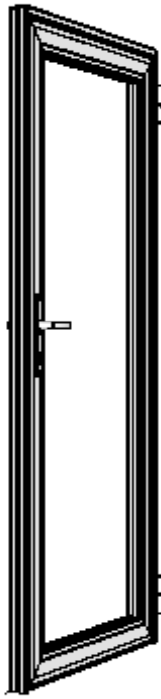
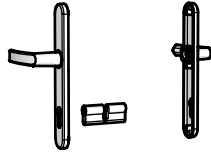

Plan: 14

Positions:

 QKRYP5x60Zn

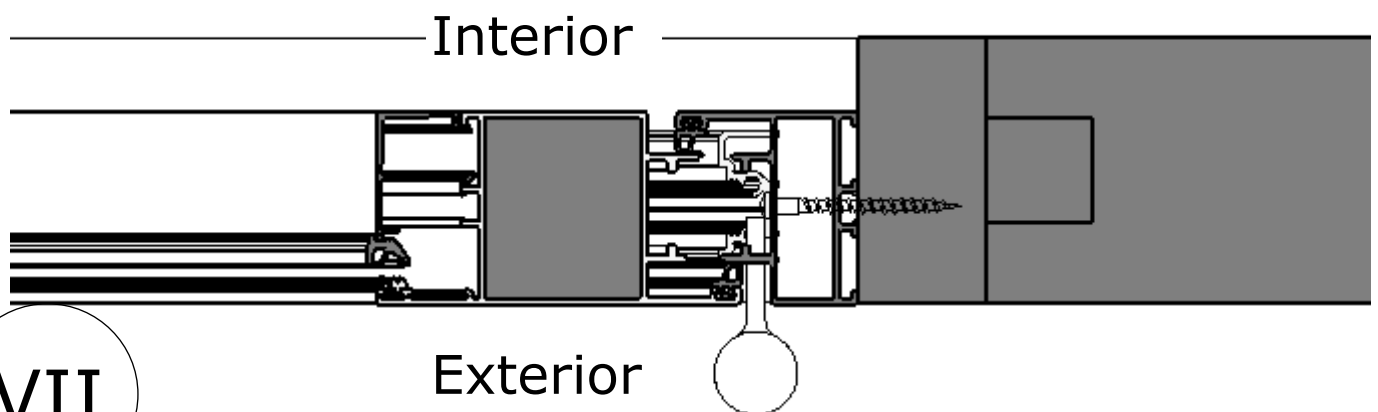
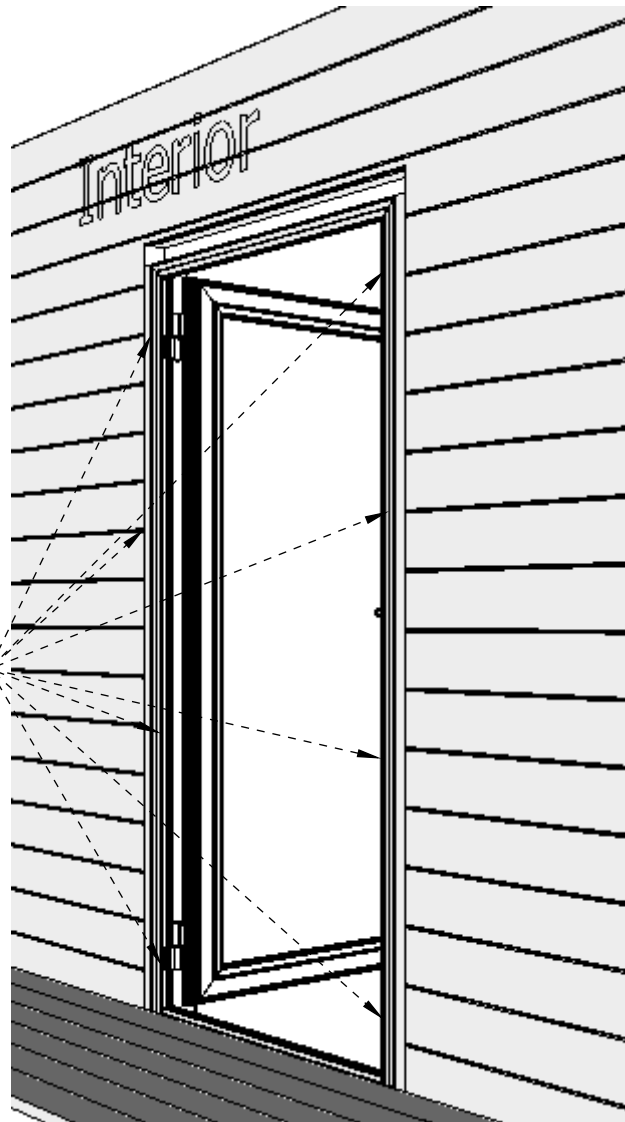

Plan: 14

Positions: Sis

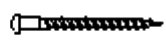

QKRYP5x60Zn

Sis

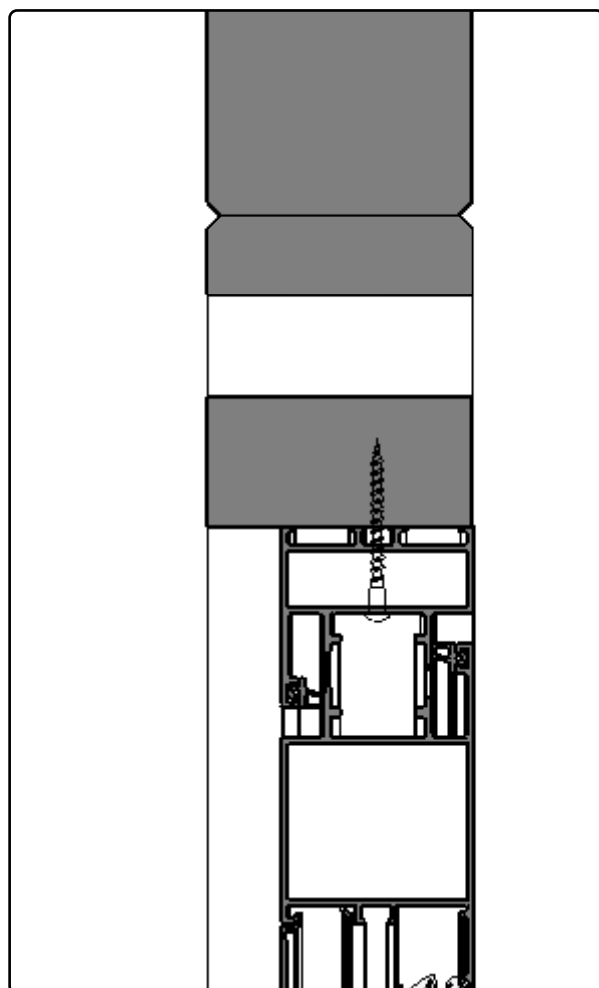
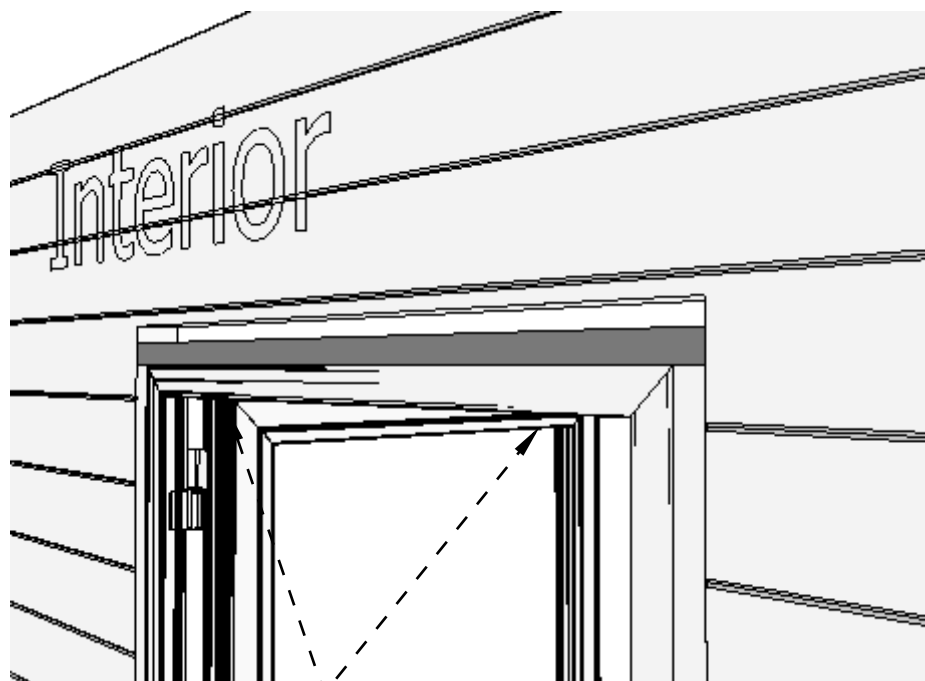
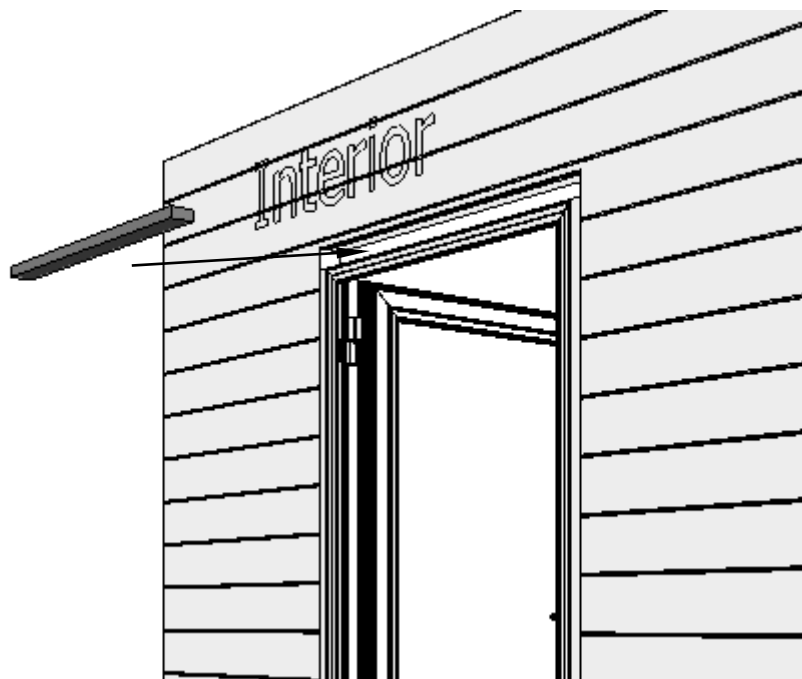

VIII



Plan: 14

Positions:

QT140-1



IX

Plan: 14

Positions: COB



QKRPP3-5x50Zn

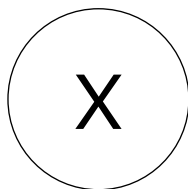

Plan: 14  
Positions:

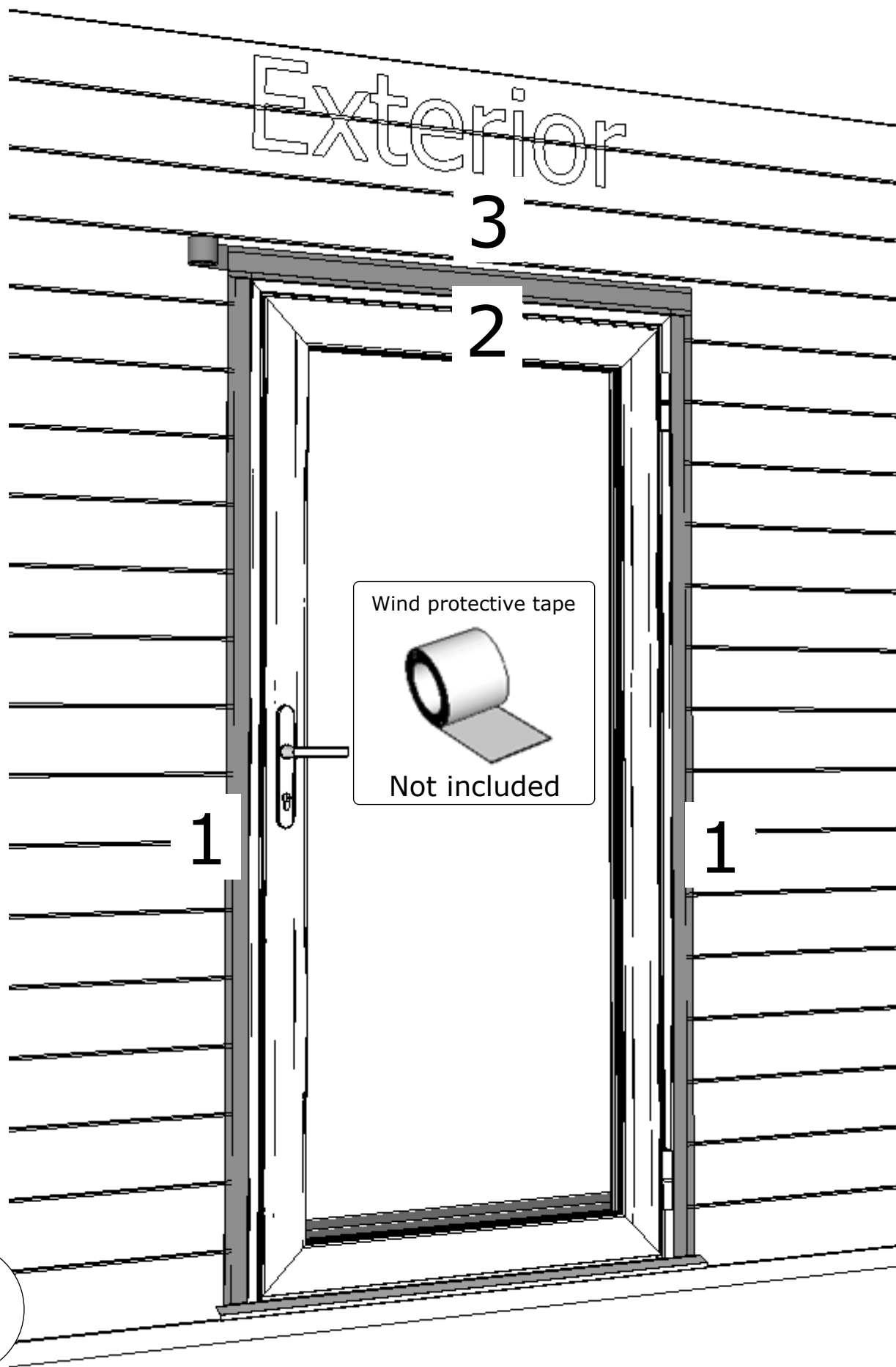

Plan: 14  
Positions: COB



QKRPP3-5x50Zn

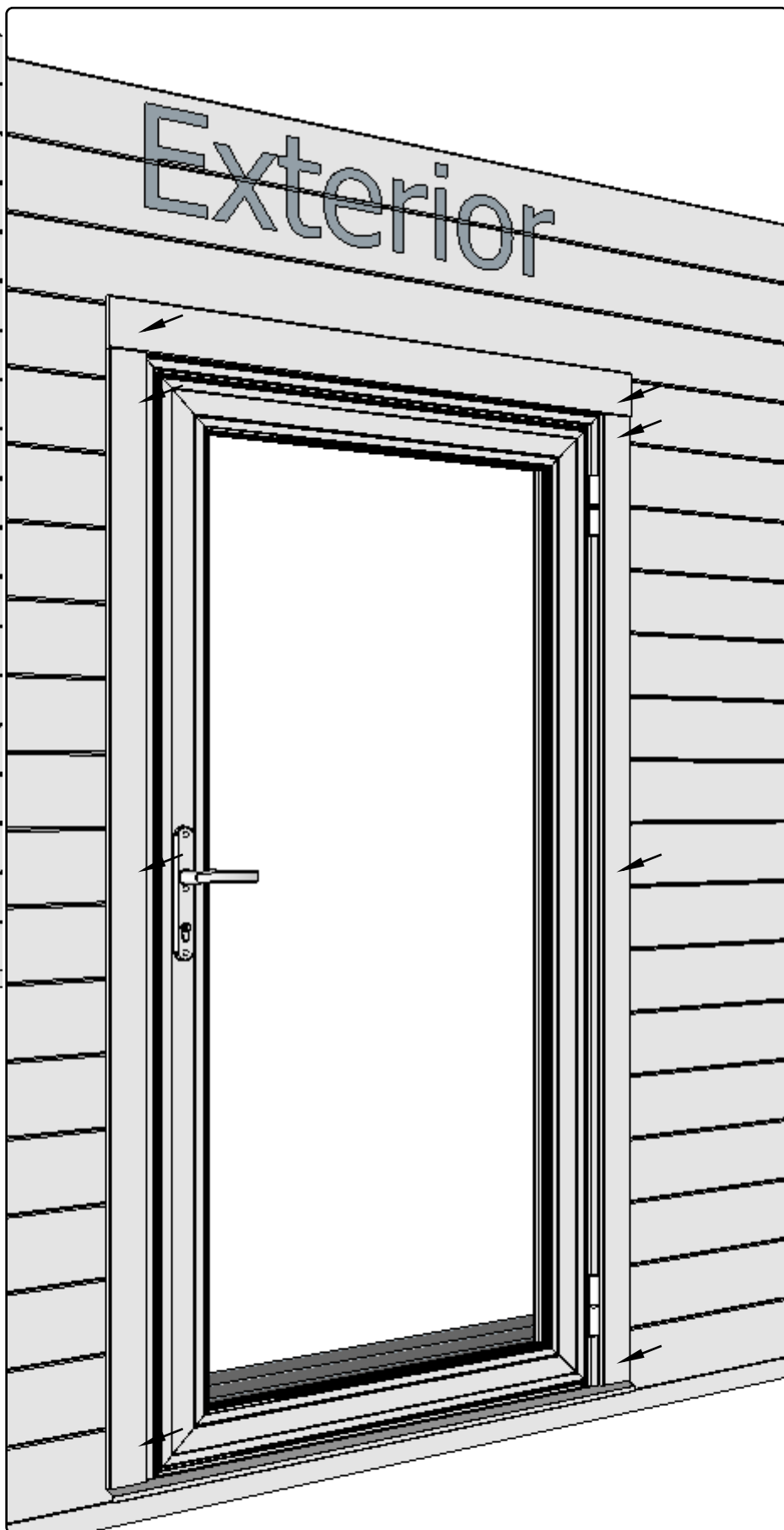
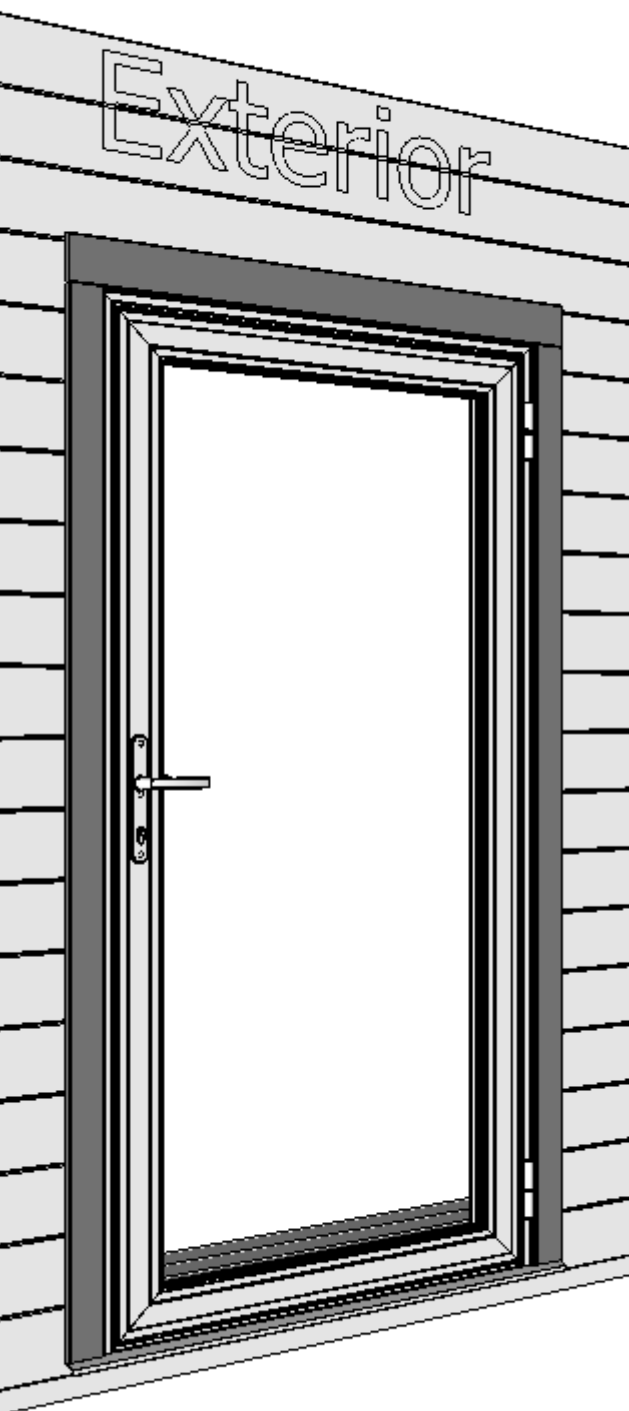



Plan: 14  
Positions: COB

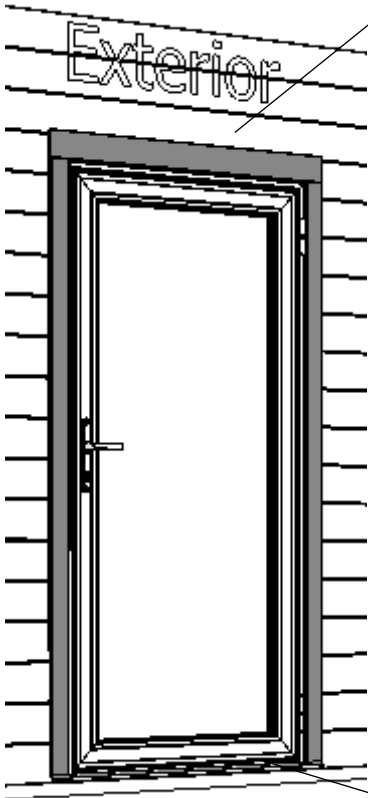

Interior

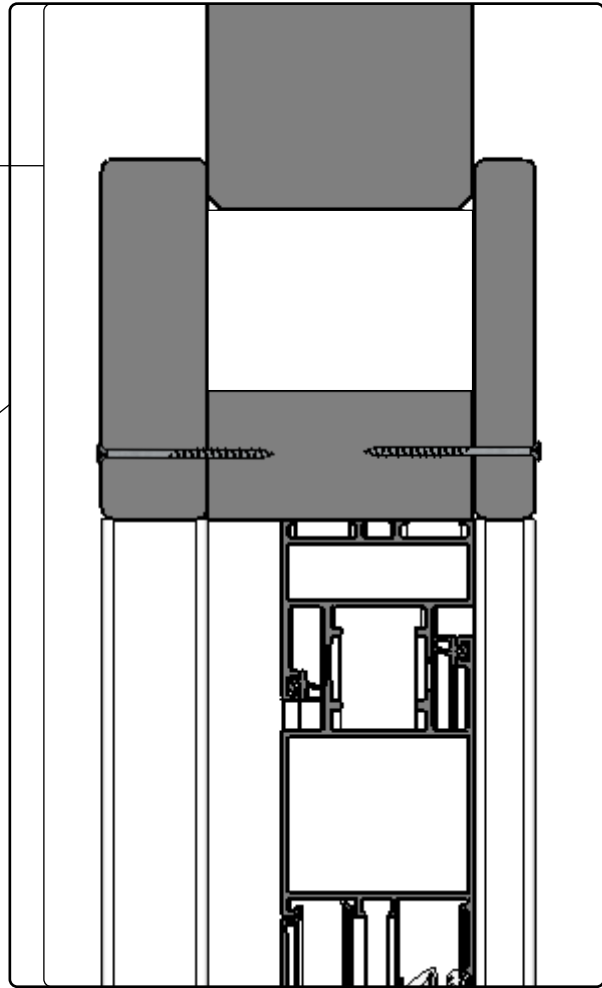

Exterior

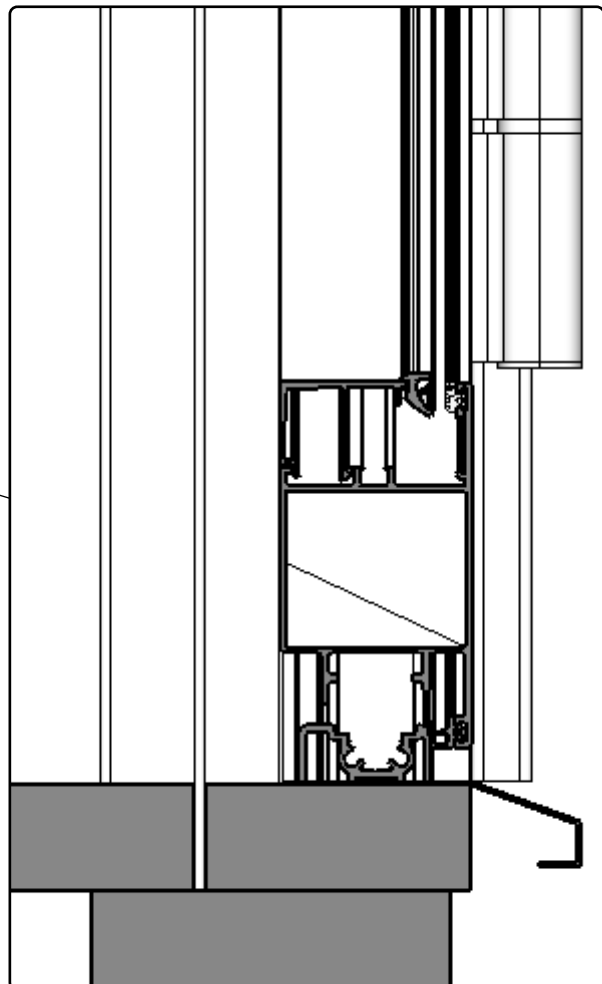

Plan: 14  
Positions: COB

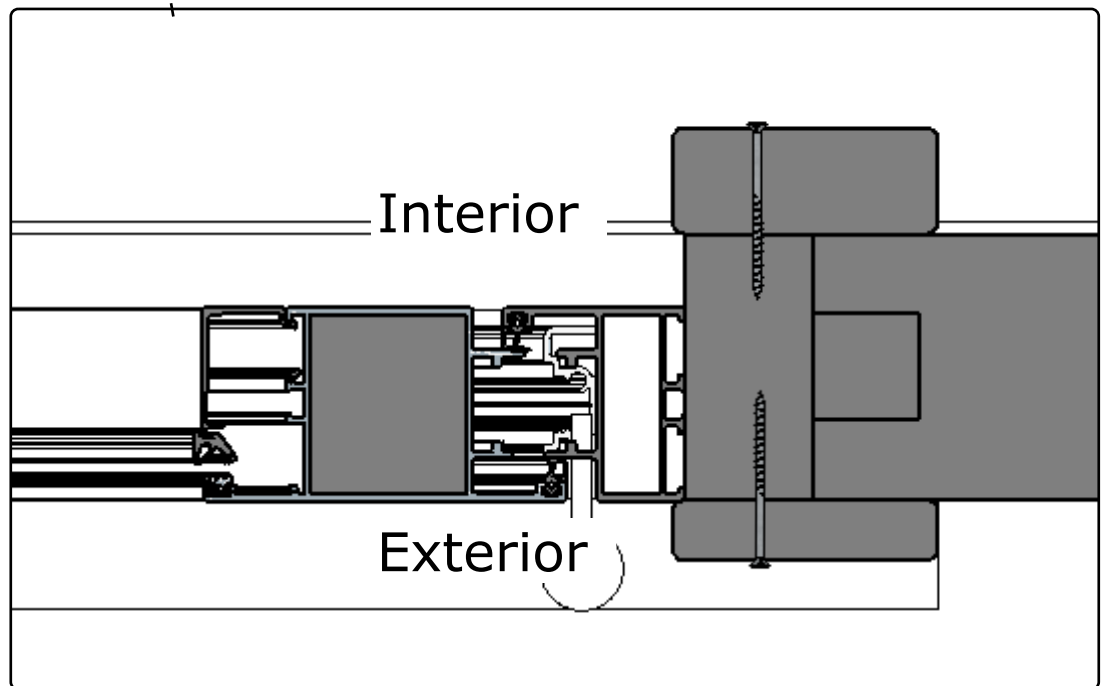
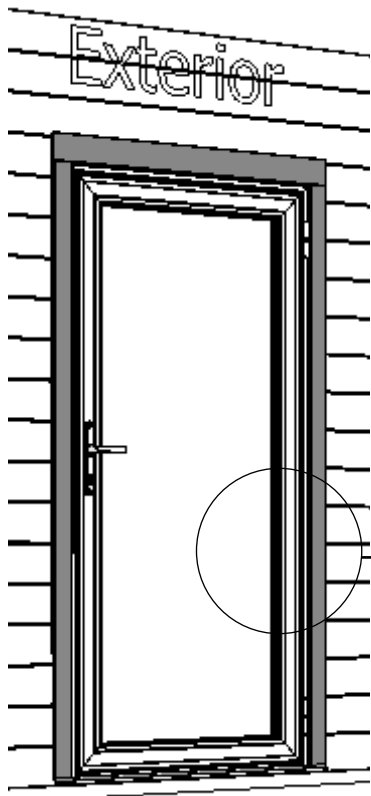

Plan: 13

Positions: A51-13

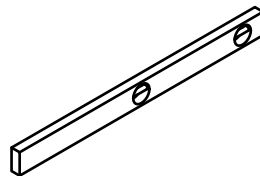
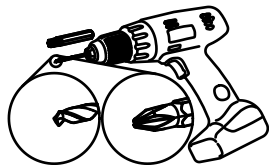
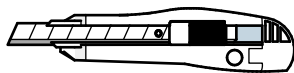
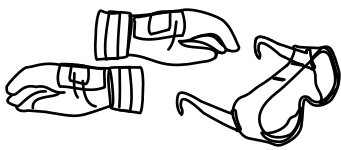
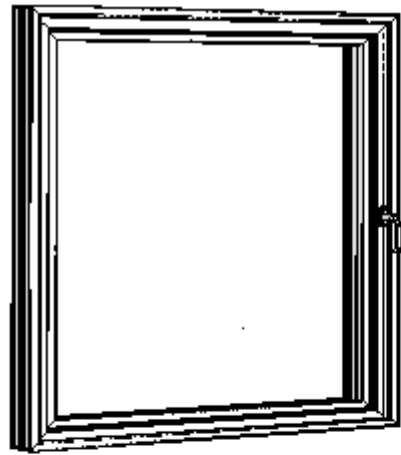
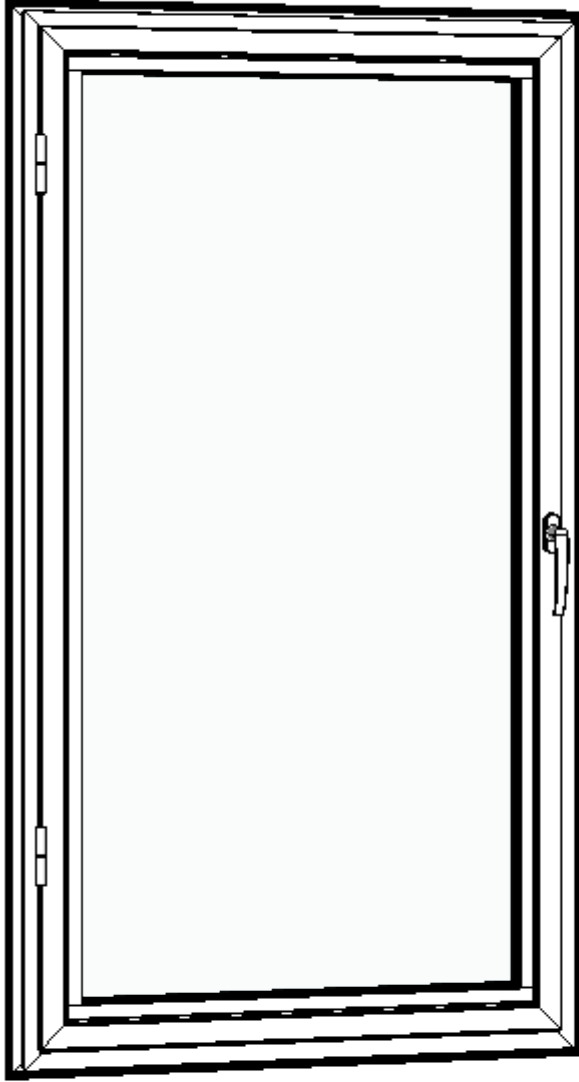

*I*

Plan: 13

Positions: QLY-ACAMAS29  
QLY-ACAMAS33

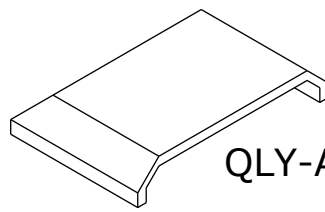

QLY-ACVG45Z

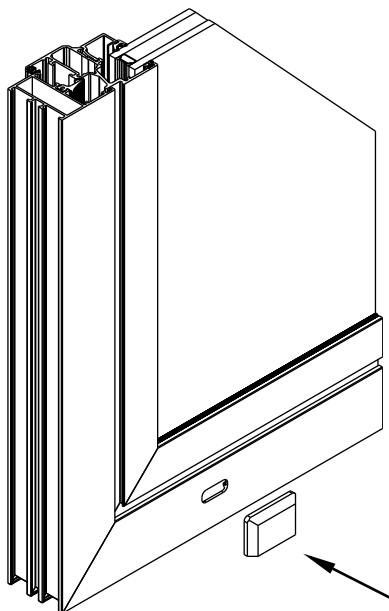
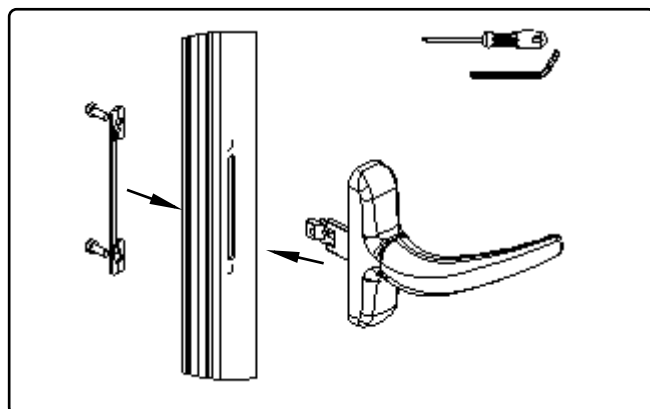
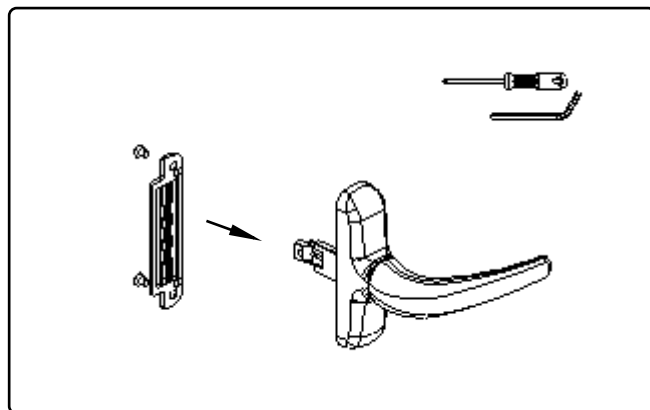
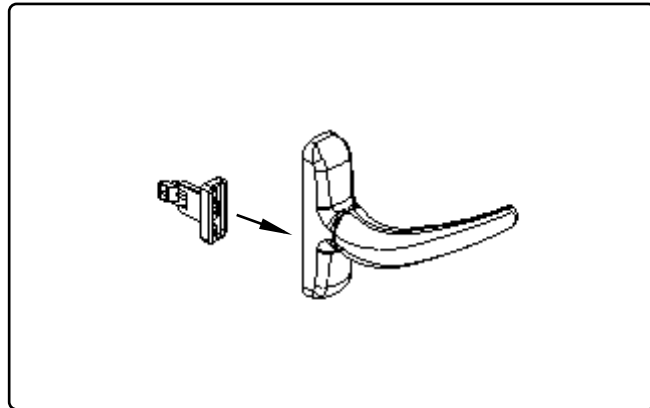
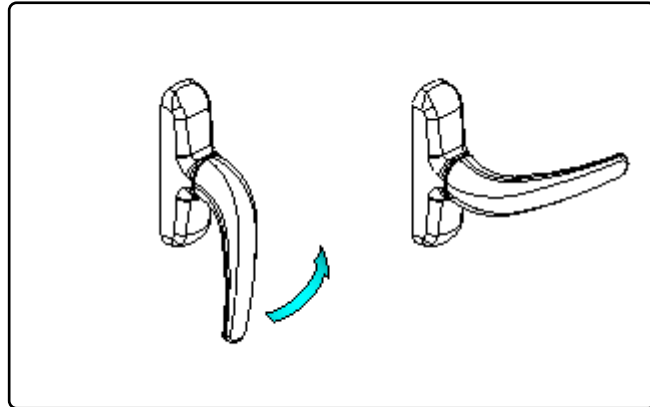
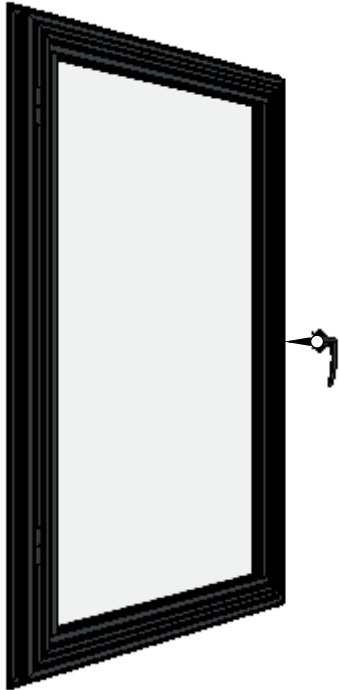

QLY-ACVG45Z

**II**

Plan: 13

Positions: COB



QKRPP3-5x50Zn

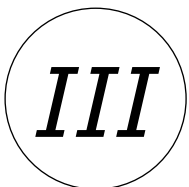
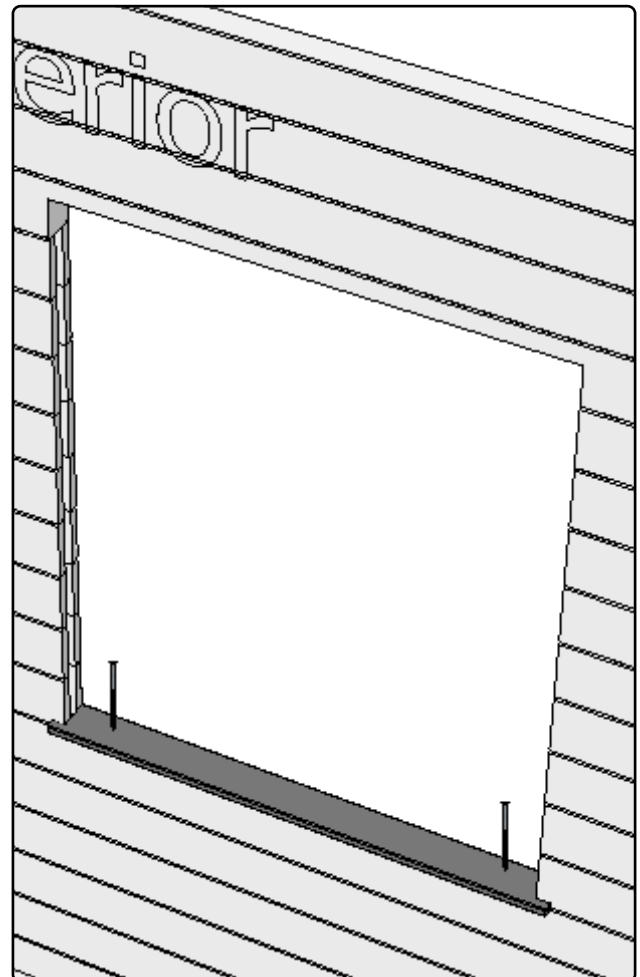
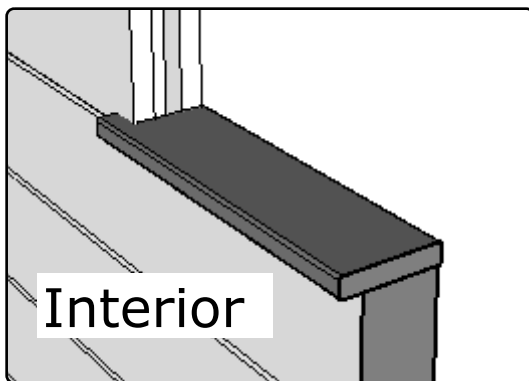
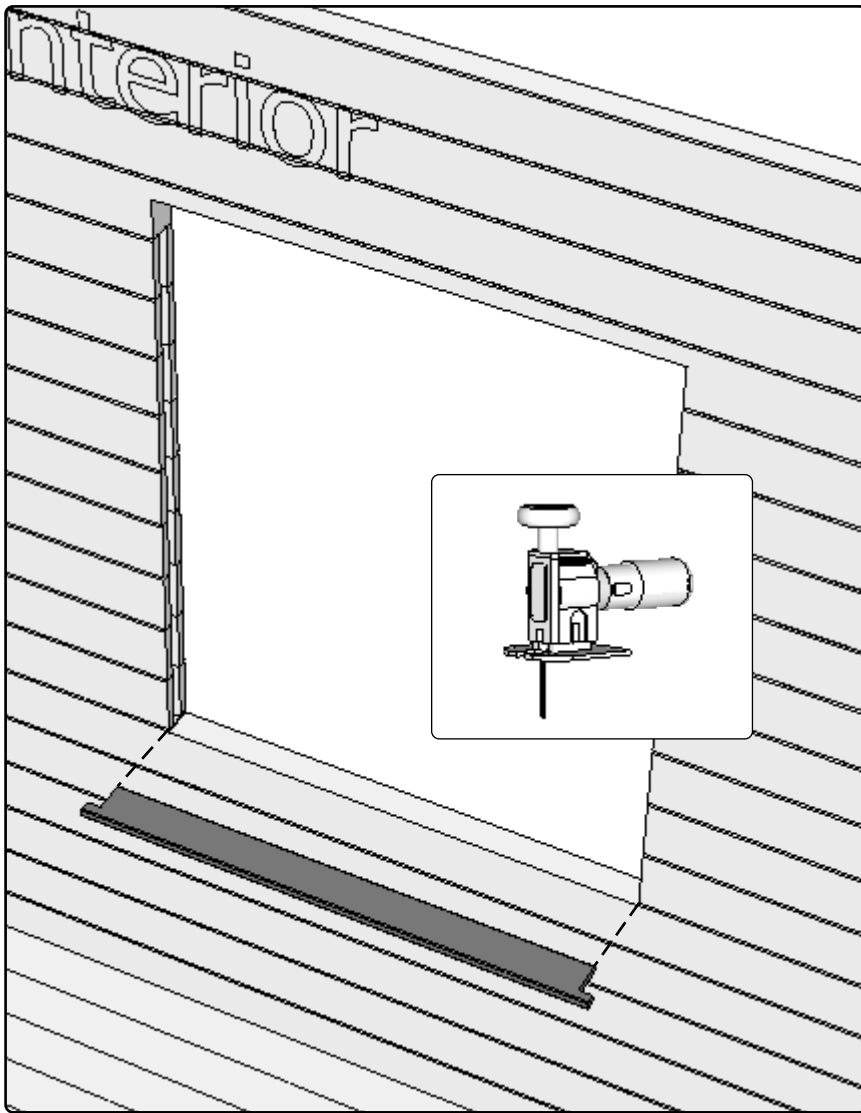

Plan: 13

Positions: TP  
Sis



QKRPP3-5x50Zn

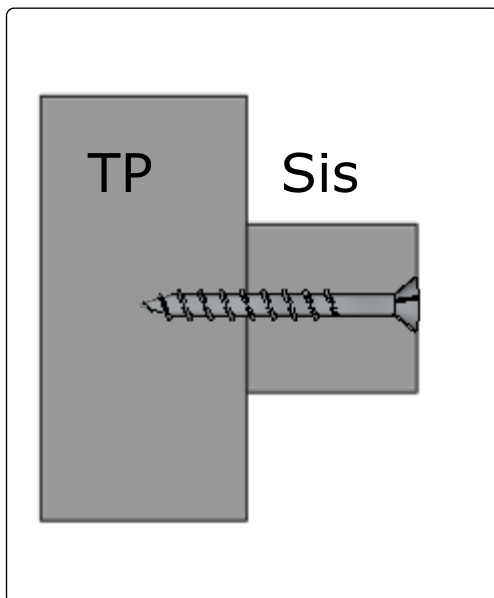
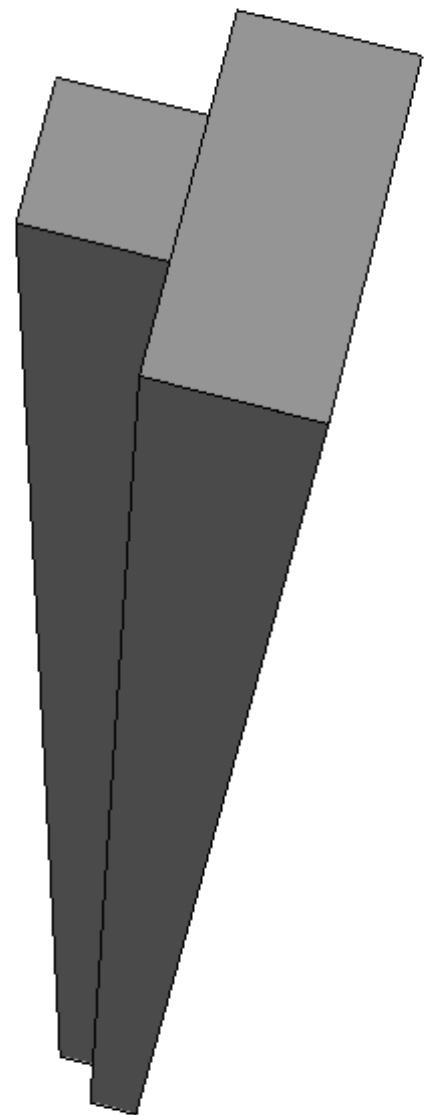
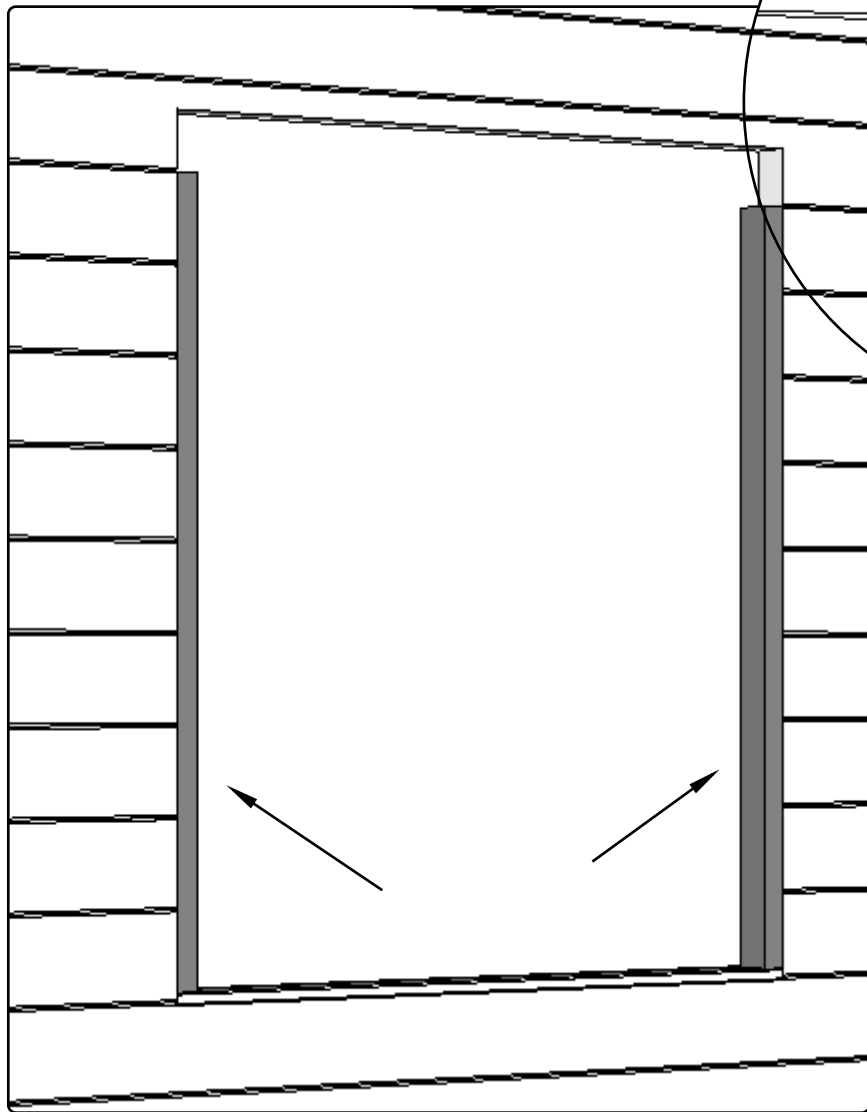
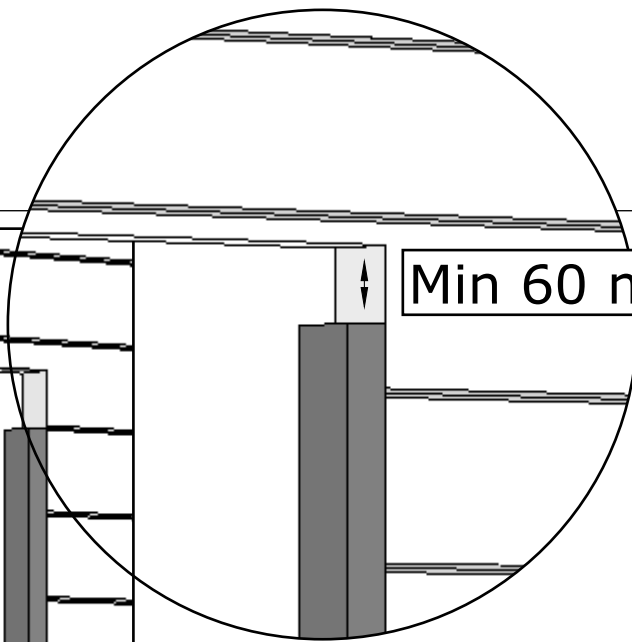

*IV*

Plan: 13

Positions: QP40x30x740

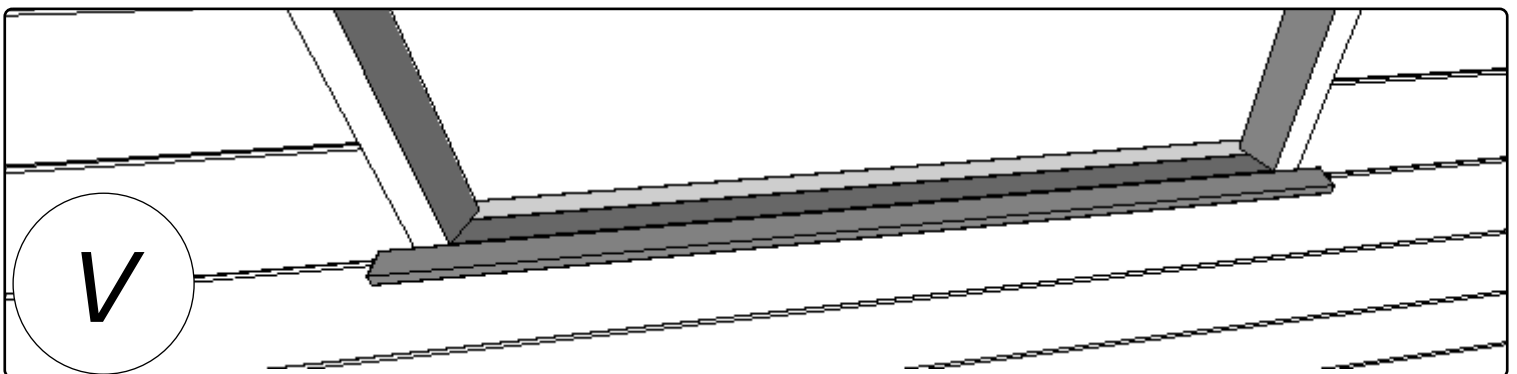
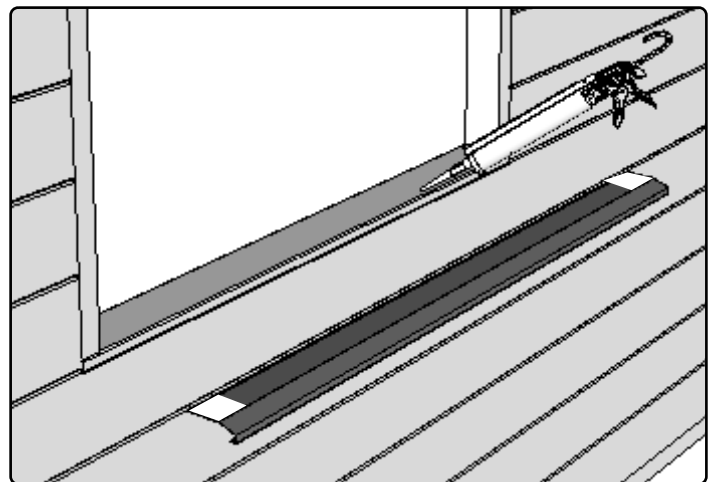
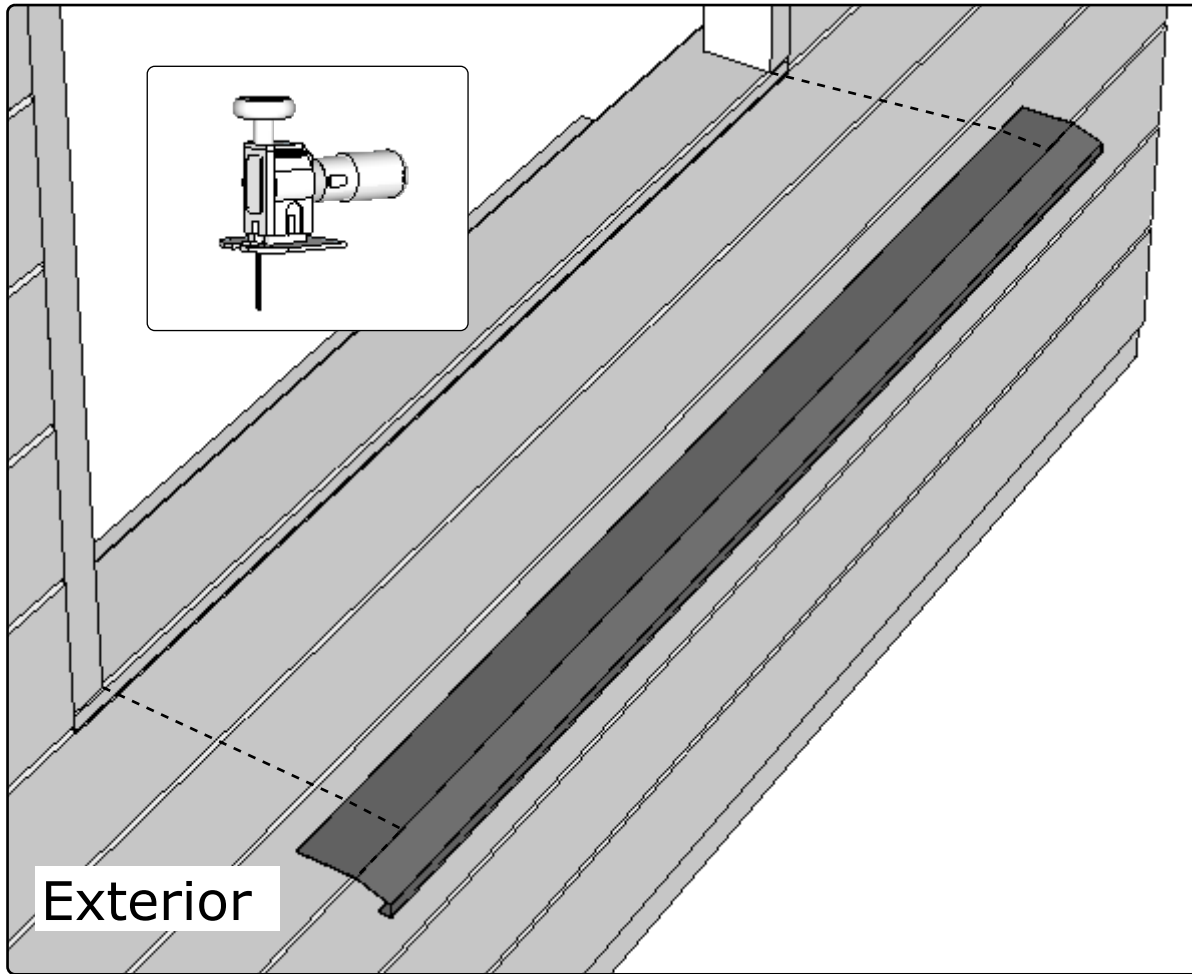

Plan: 13  
Positions:

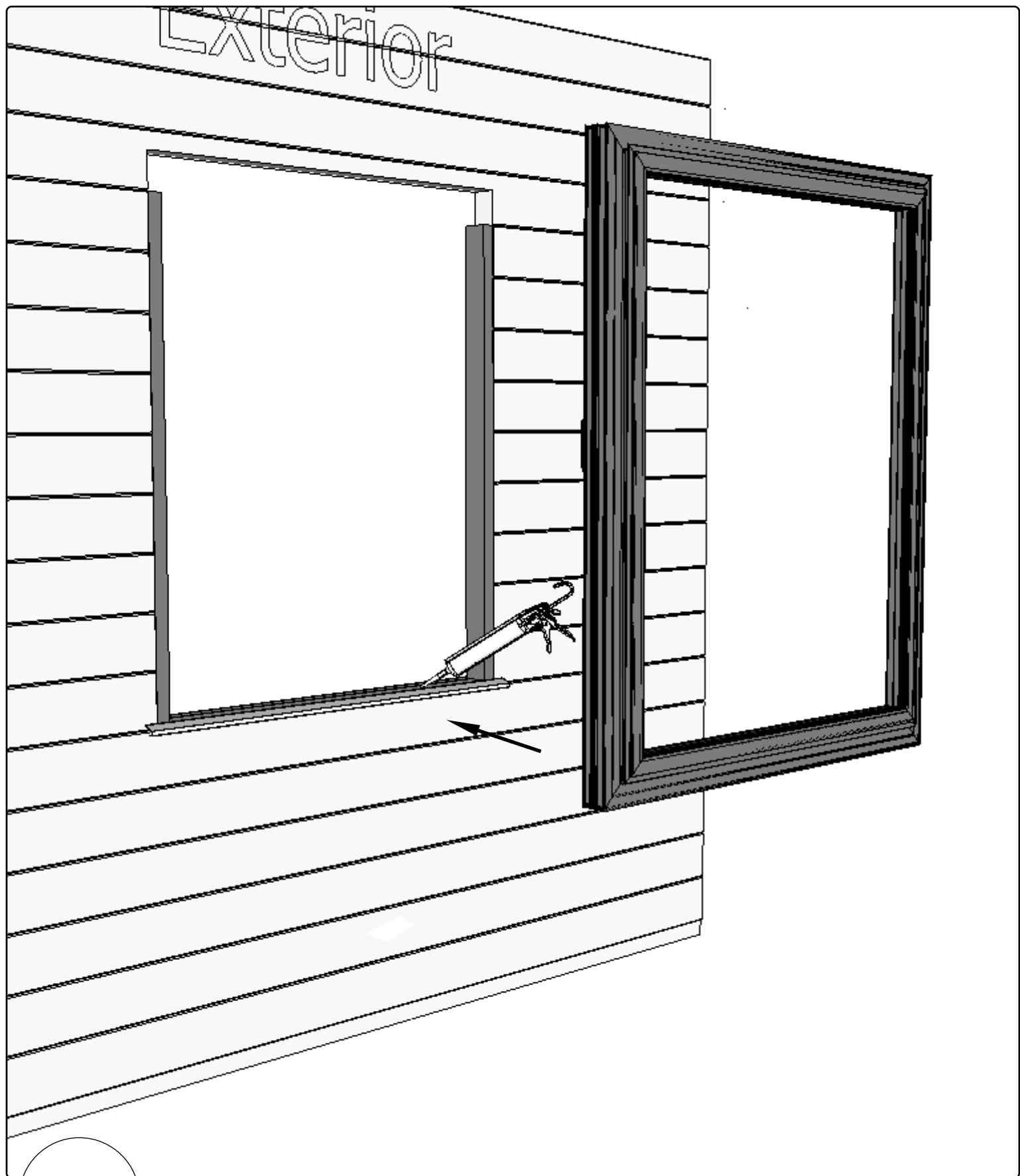

*VI*



Plan: 13

Positions:

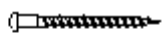

QKRYP5x60Zn

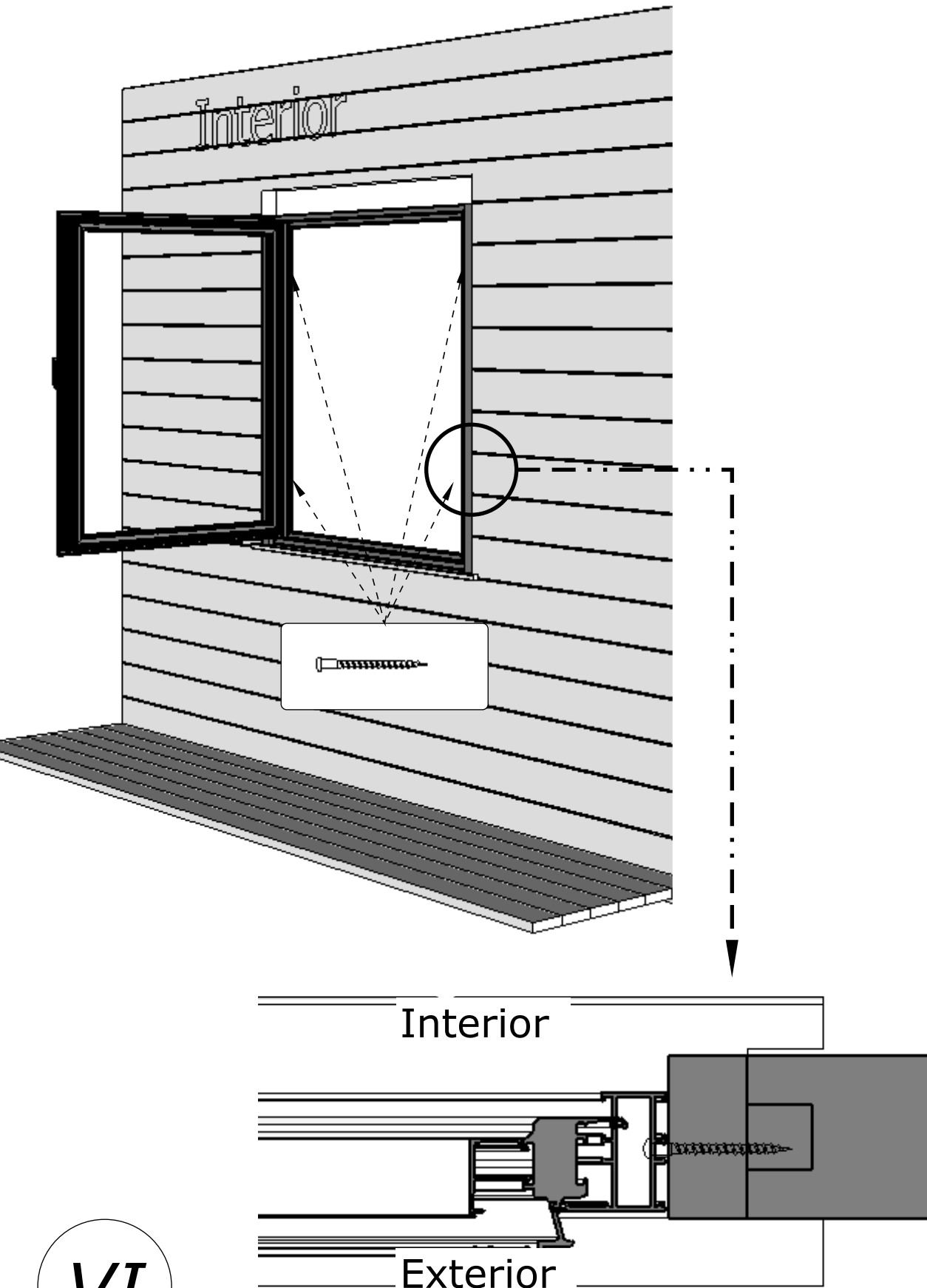

*VI*

Plan: 13

Positions: Sis

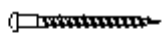

QKRYP5x60Zn

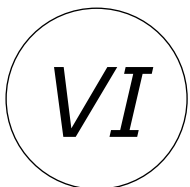
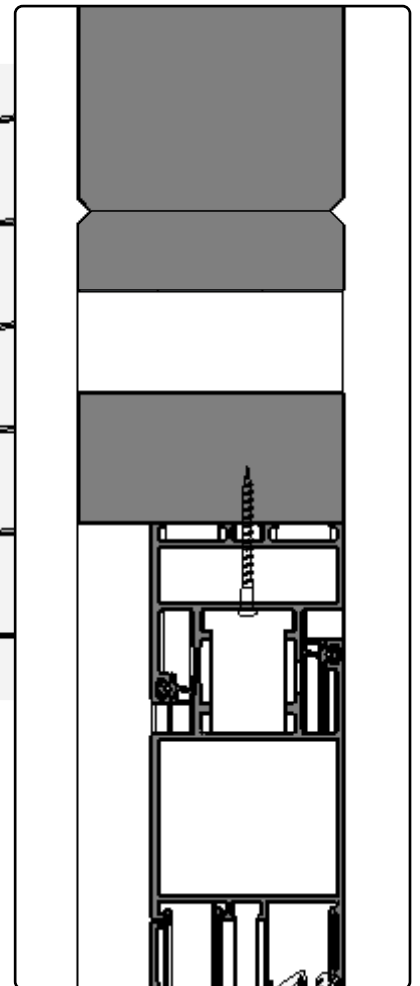
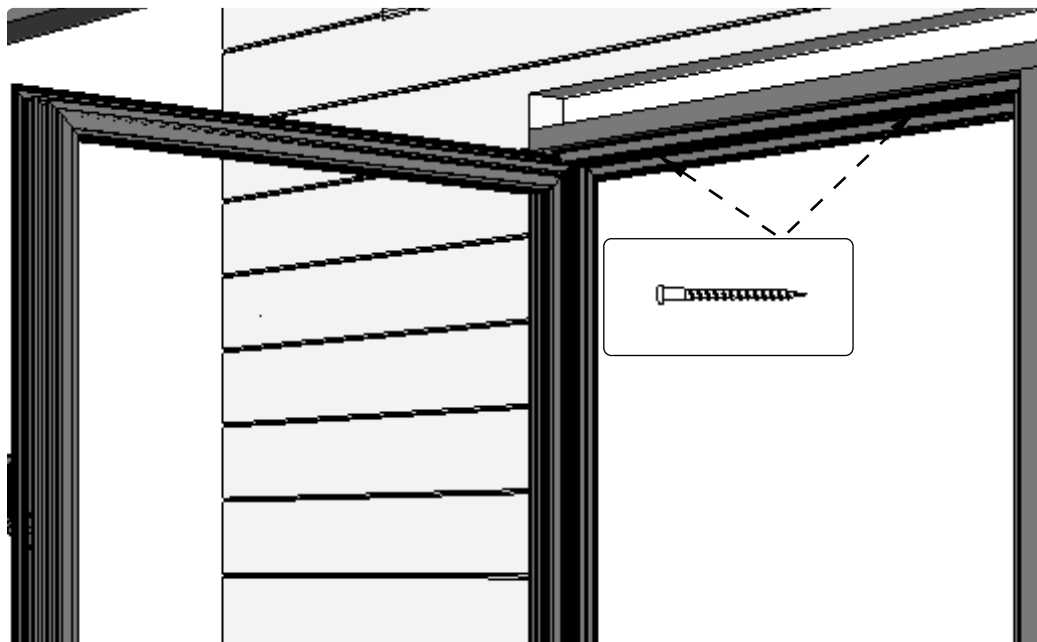
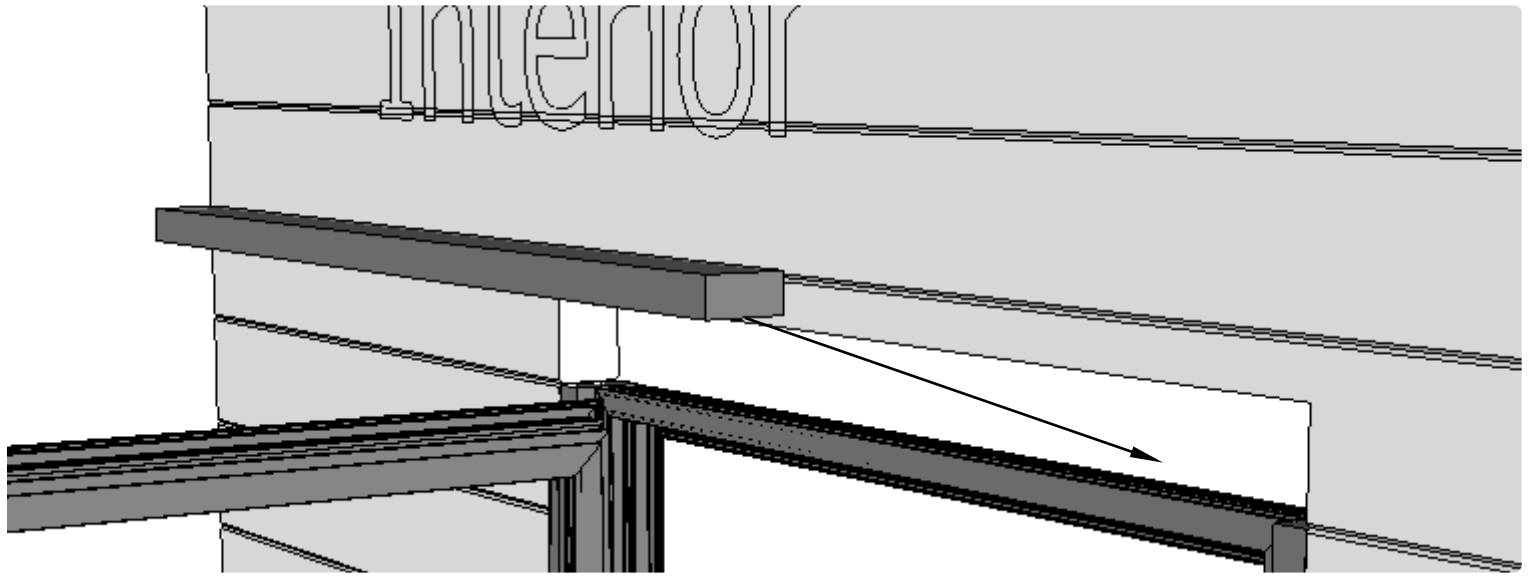

Plan: 13  
Positions:

QT140-1



Plan: 13

Positions:

COB

QKRPP3-5x50Zn

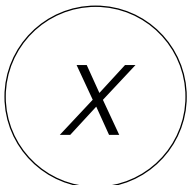
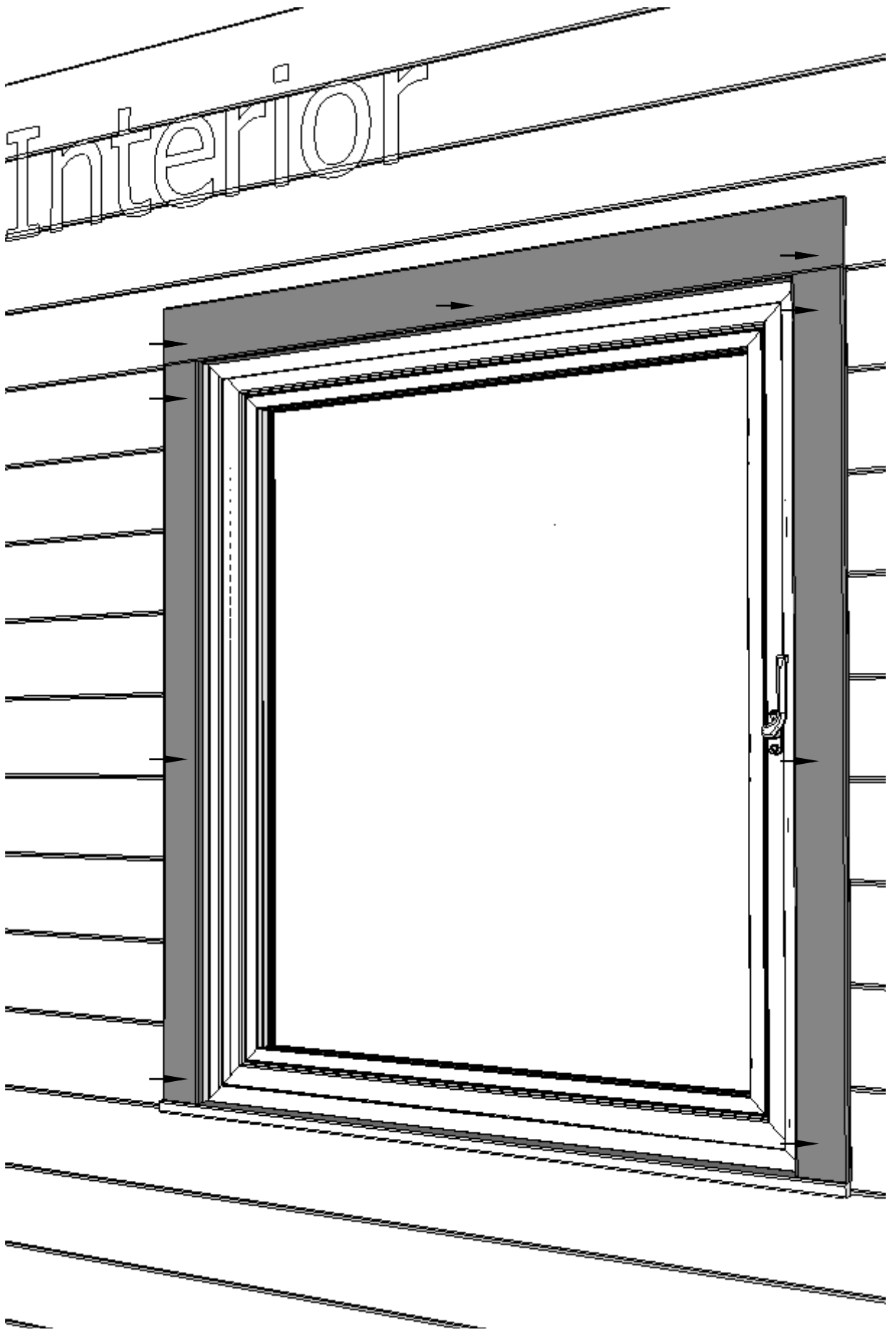

Plan: 13  
Positions:

Exterior

3

2

1

1

Wind protective tape

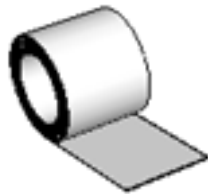

Not included

*XI*

Plan: 13

Positions:

COB

QKRPP3-5x50Zn



Exterior

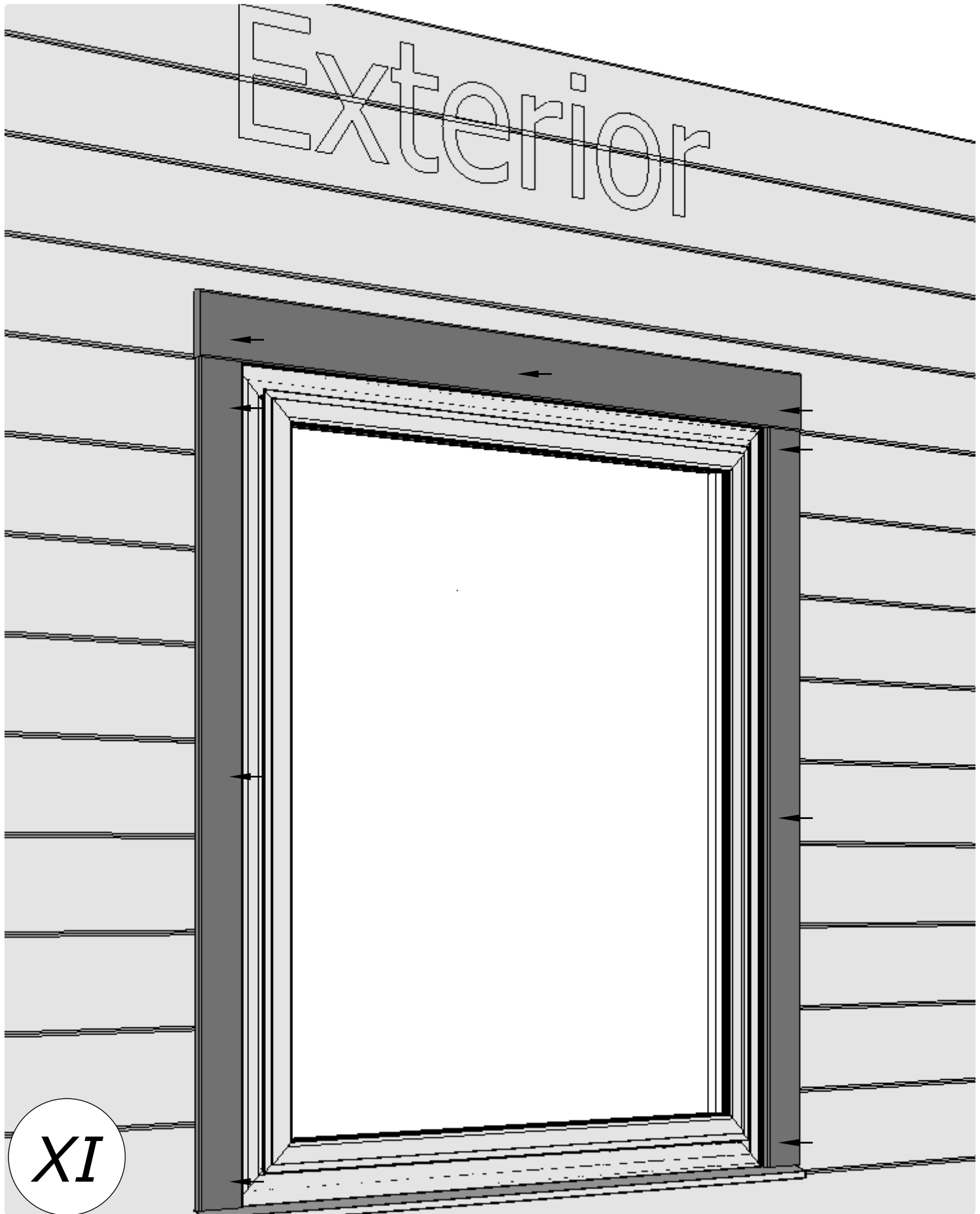

*XI*

Plan: 13

Positions:

COB

QKRPP3-5x50Zn

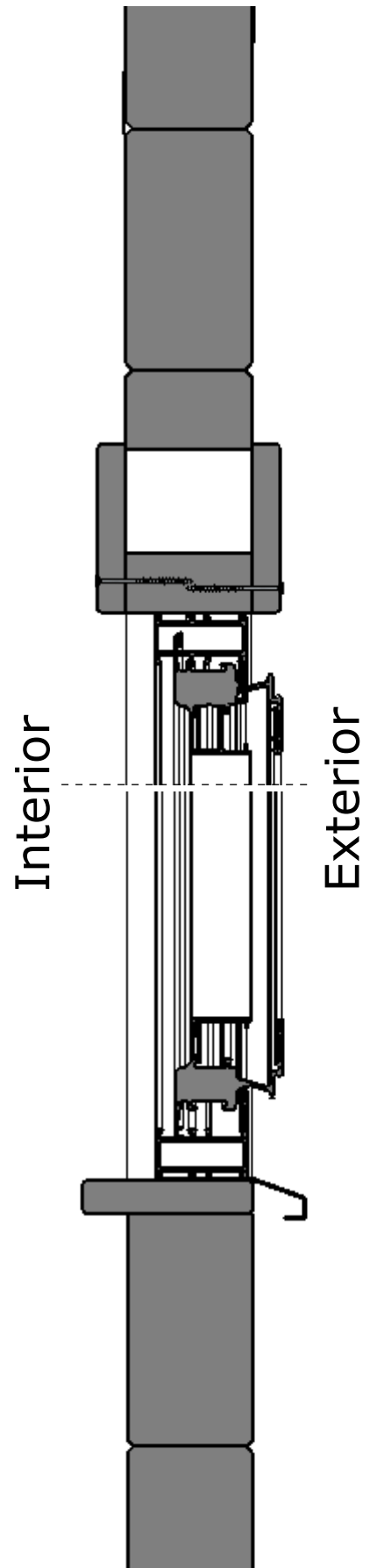
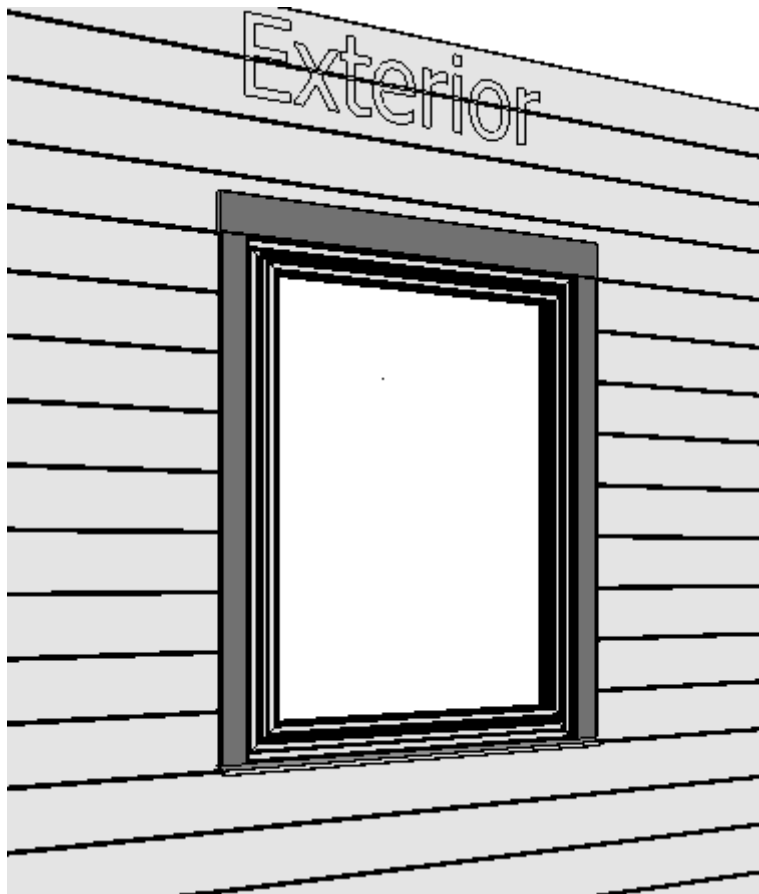

Interior

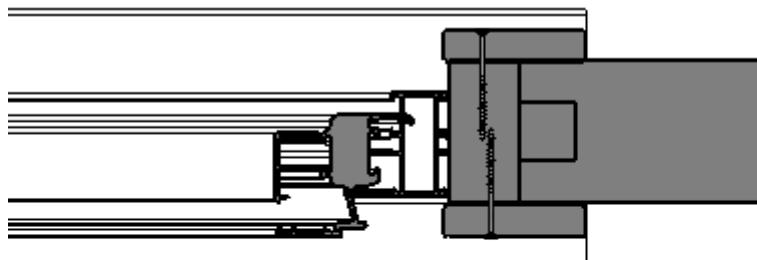

Exterior

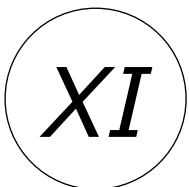

Plan: 13-C A51-15-7016  
Positions:

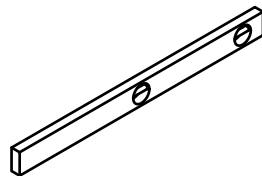
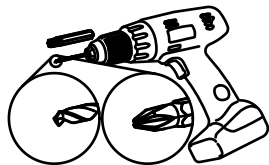
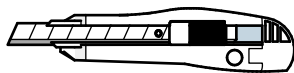
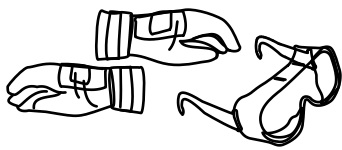
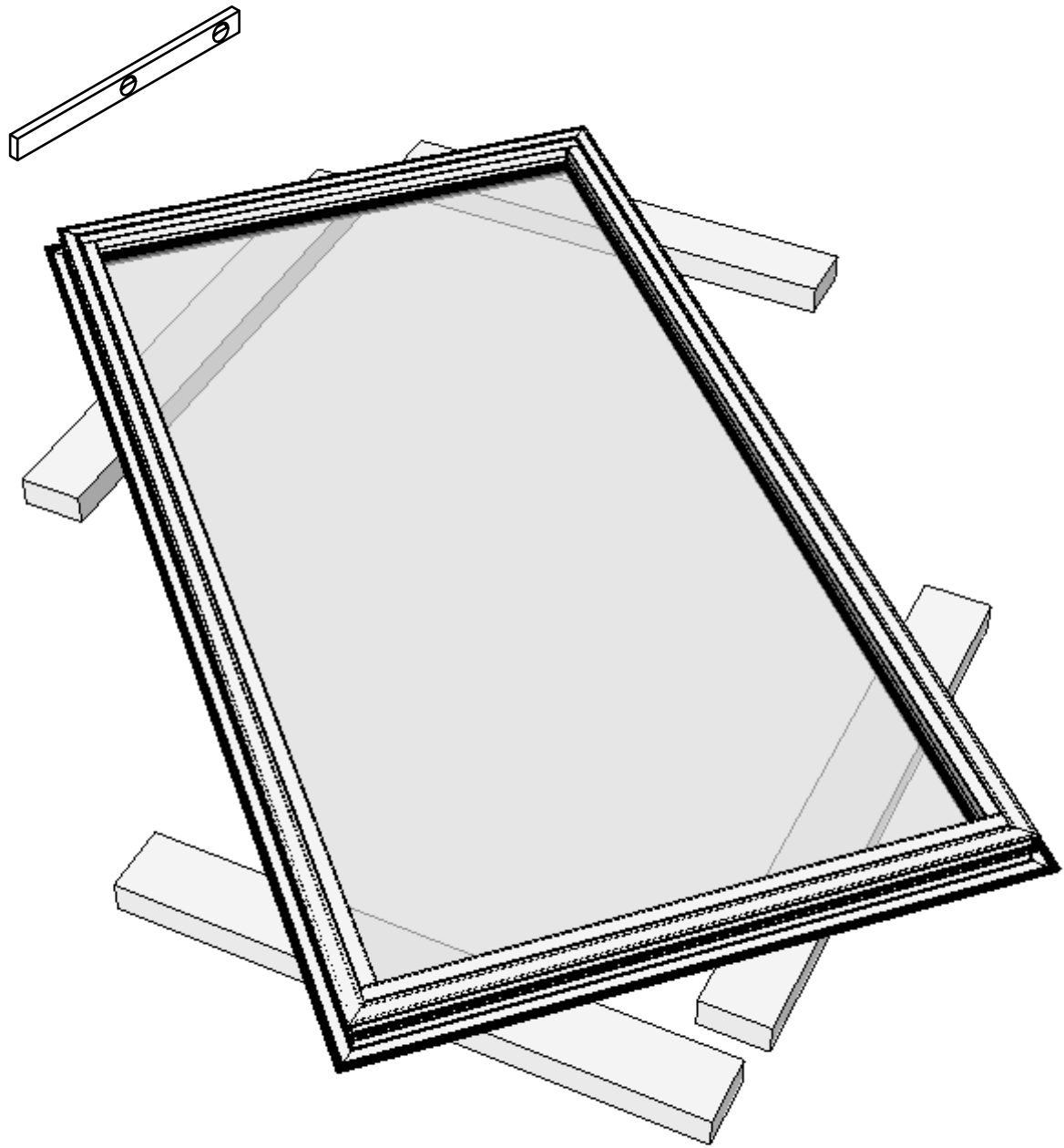

*I*



Plan: 13-C A51-15-7016  
Positions:

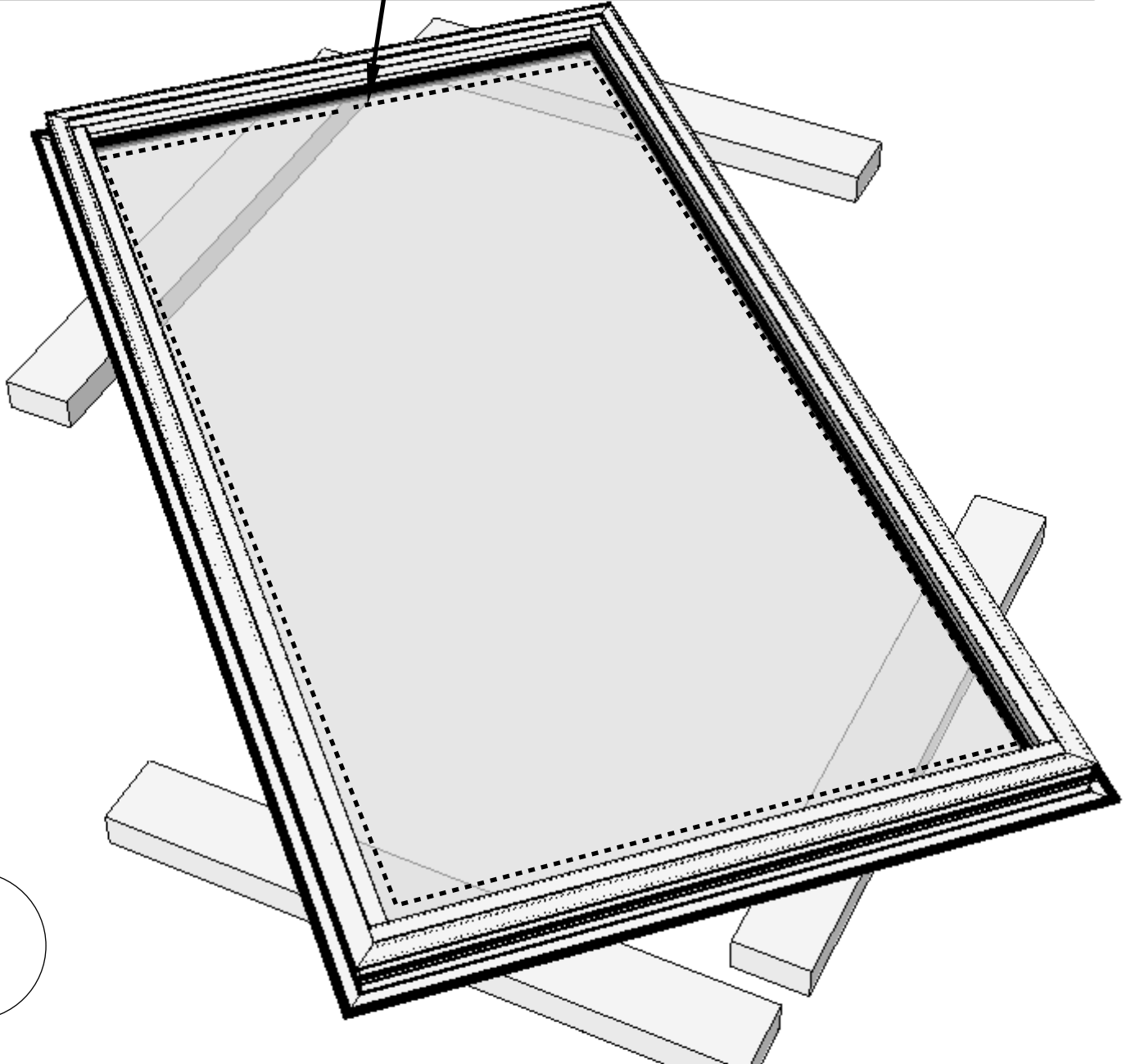
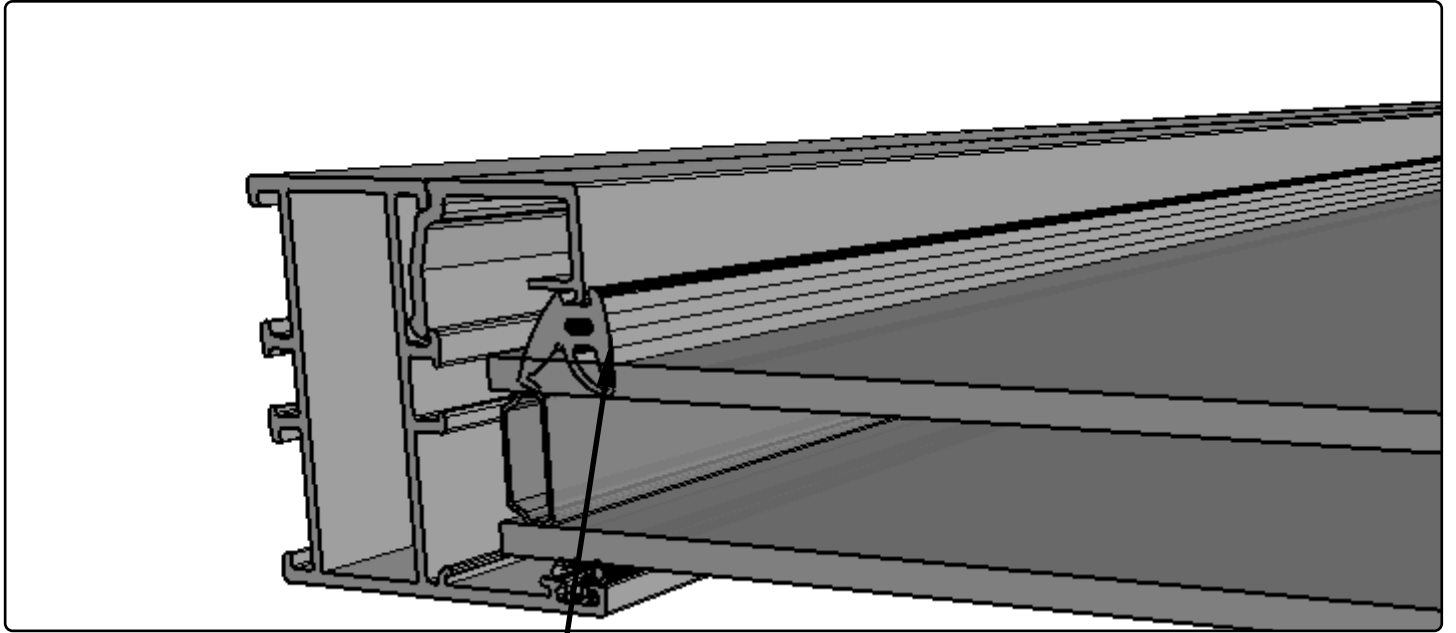

*II*

Plan: 13-C A51-15-7016  
Positions:

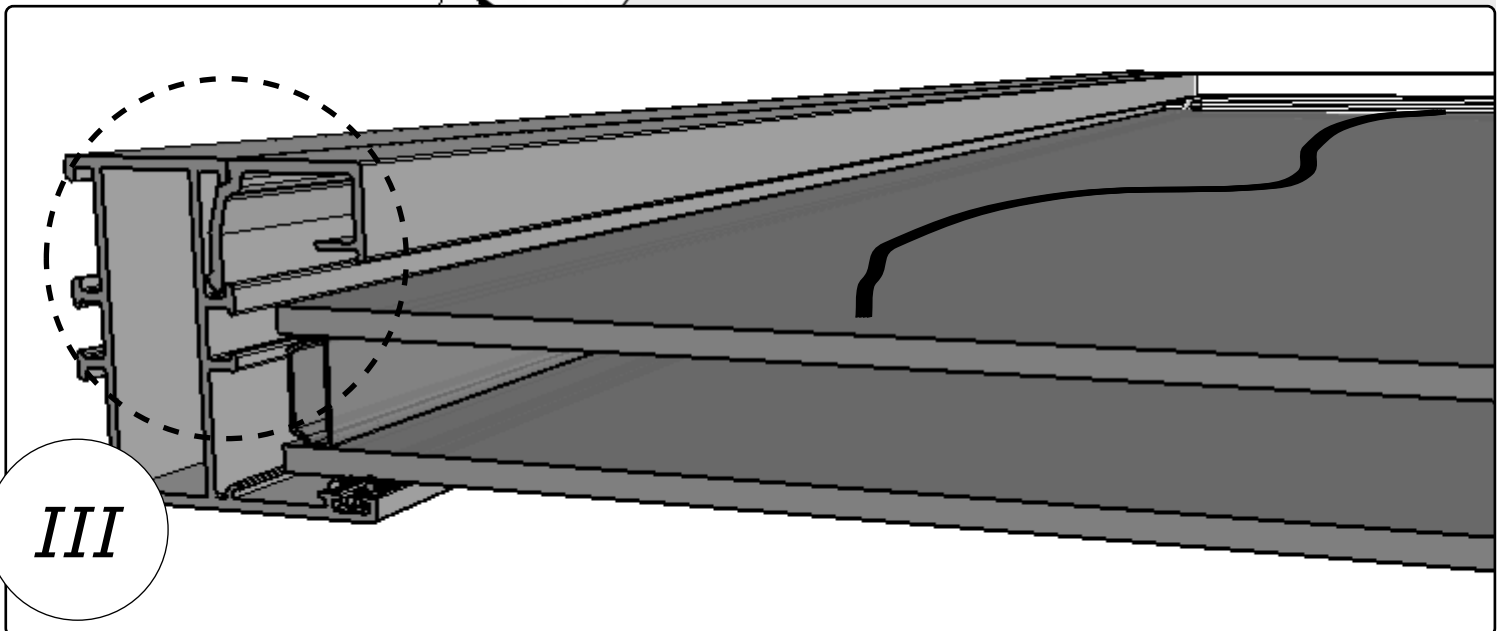
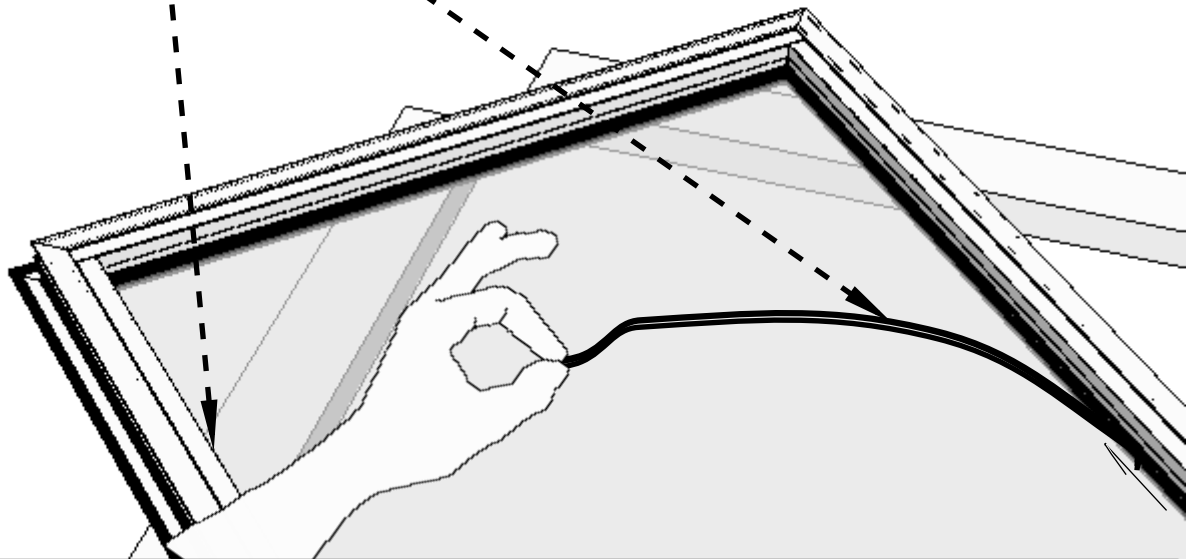
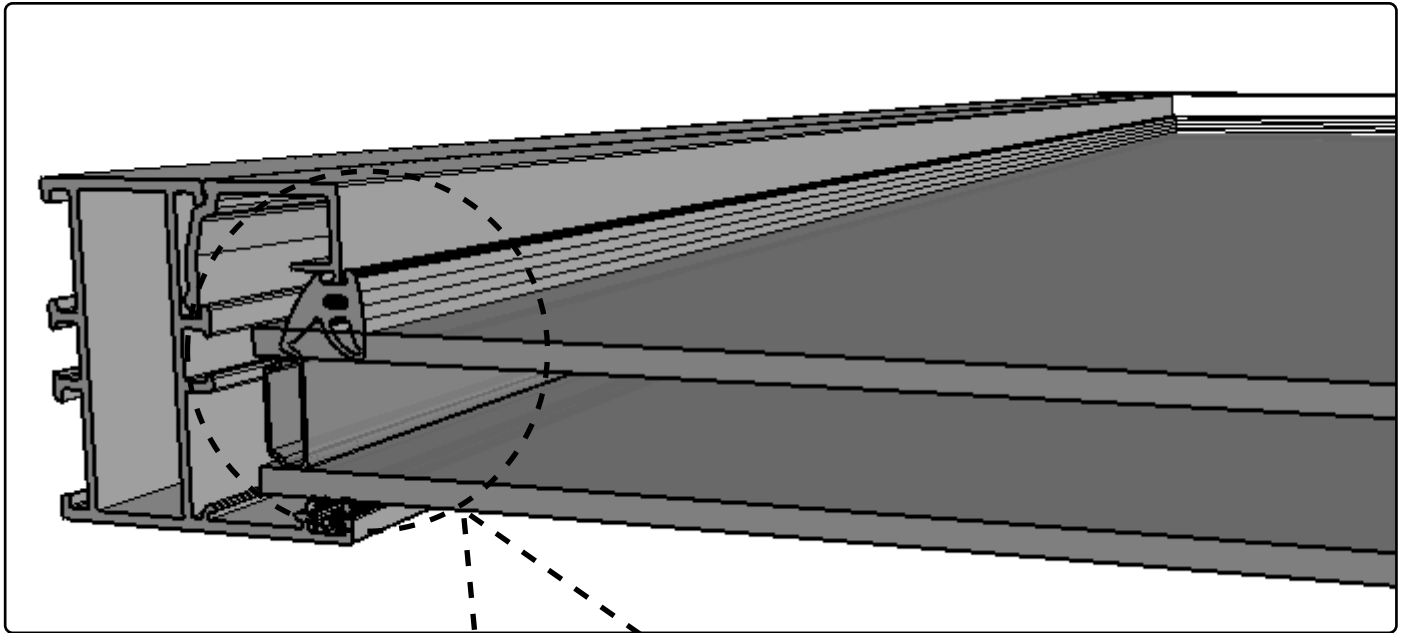

Plan: 13-C A51-15-7016  
Positions:

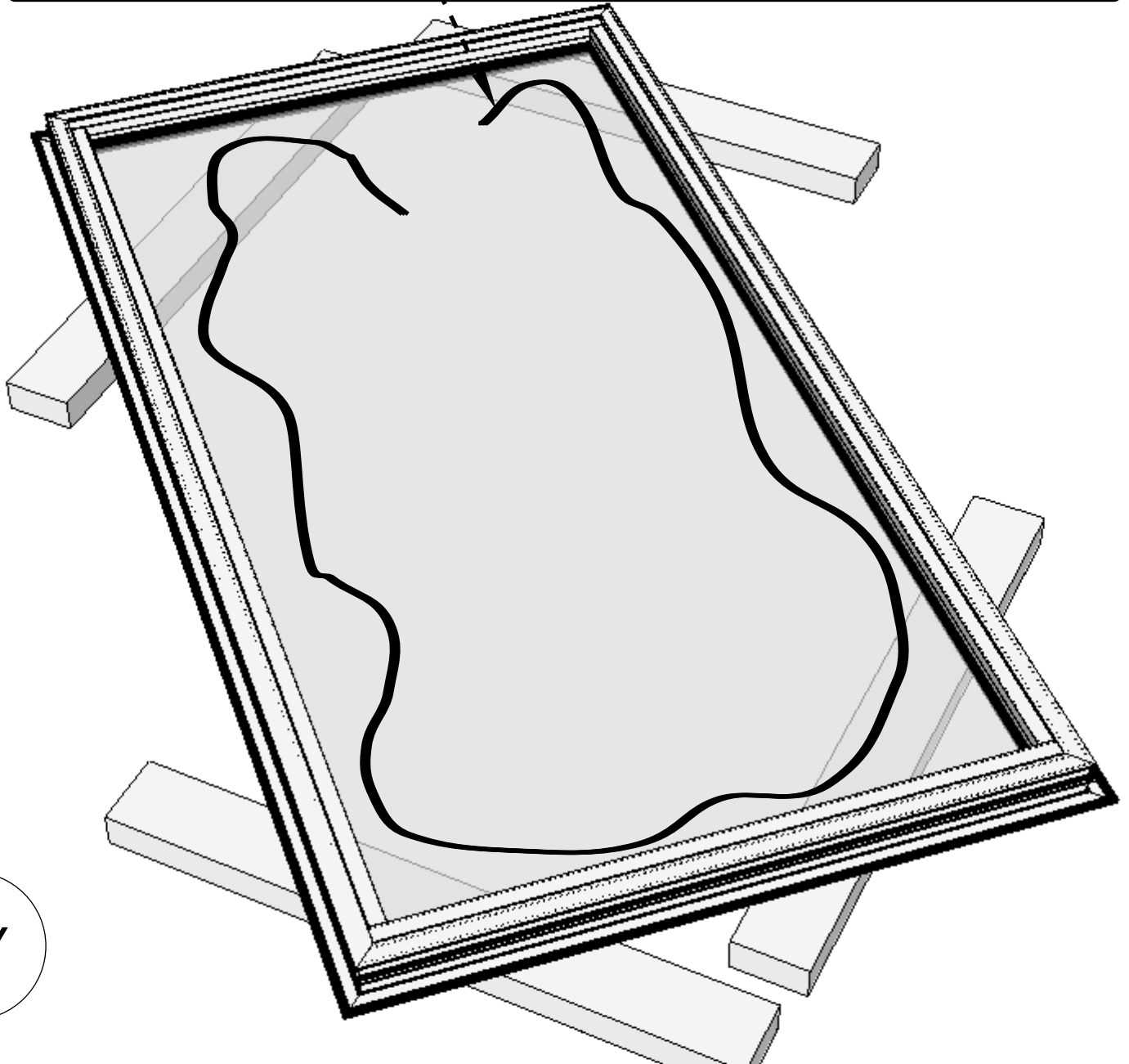
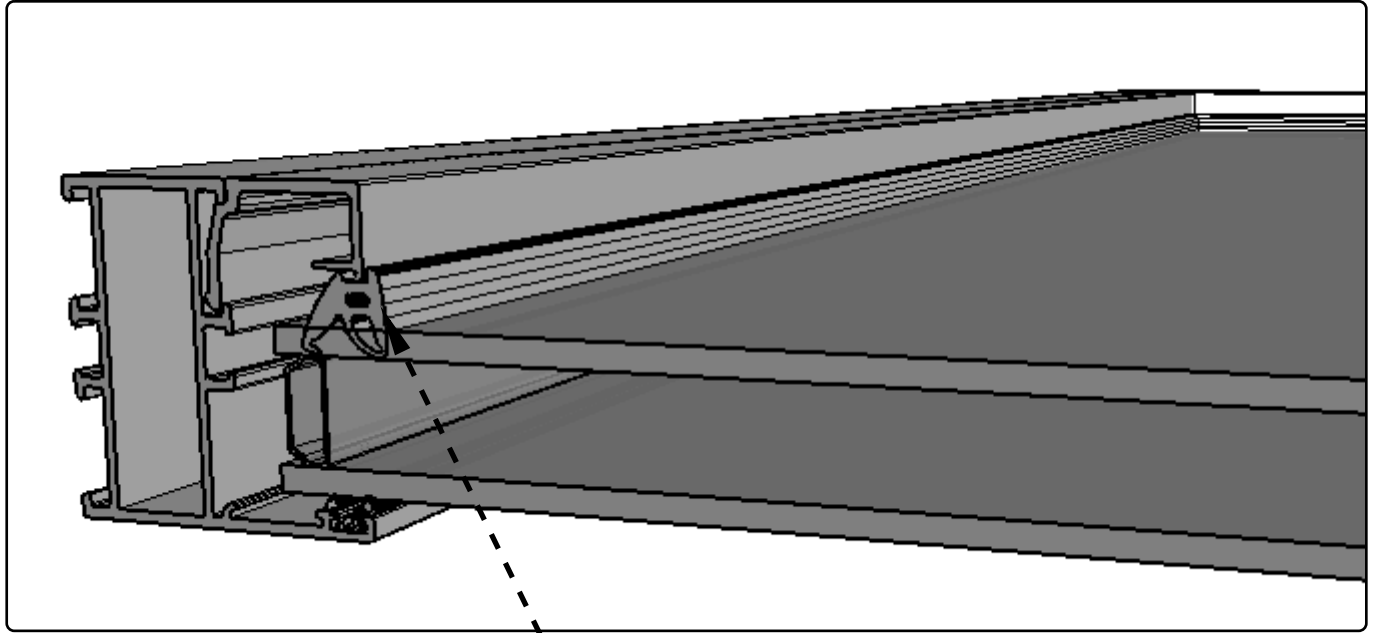

*IV*

Plan: 13-C A51-15-7016  
Positions:

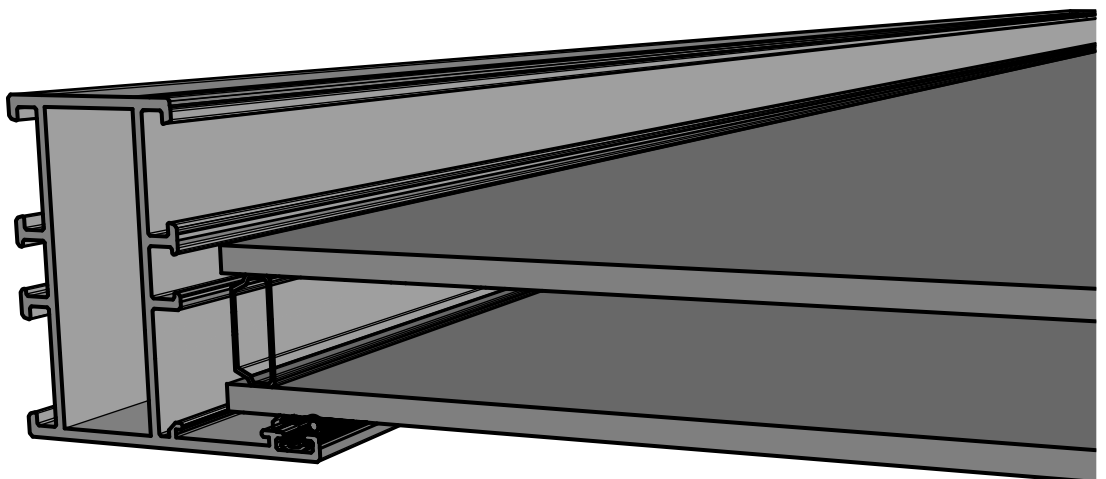
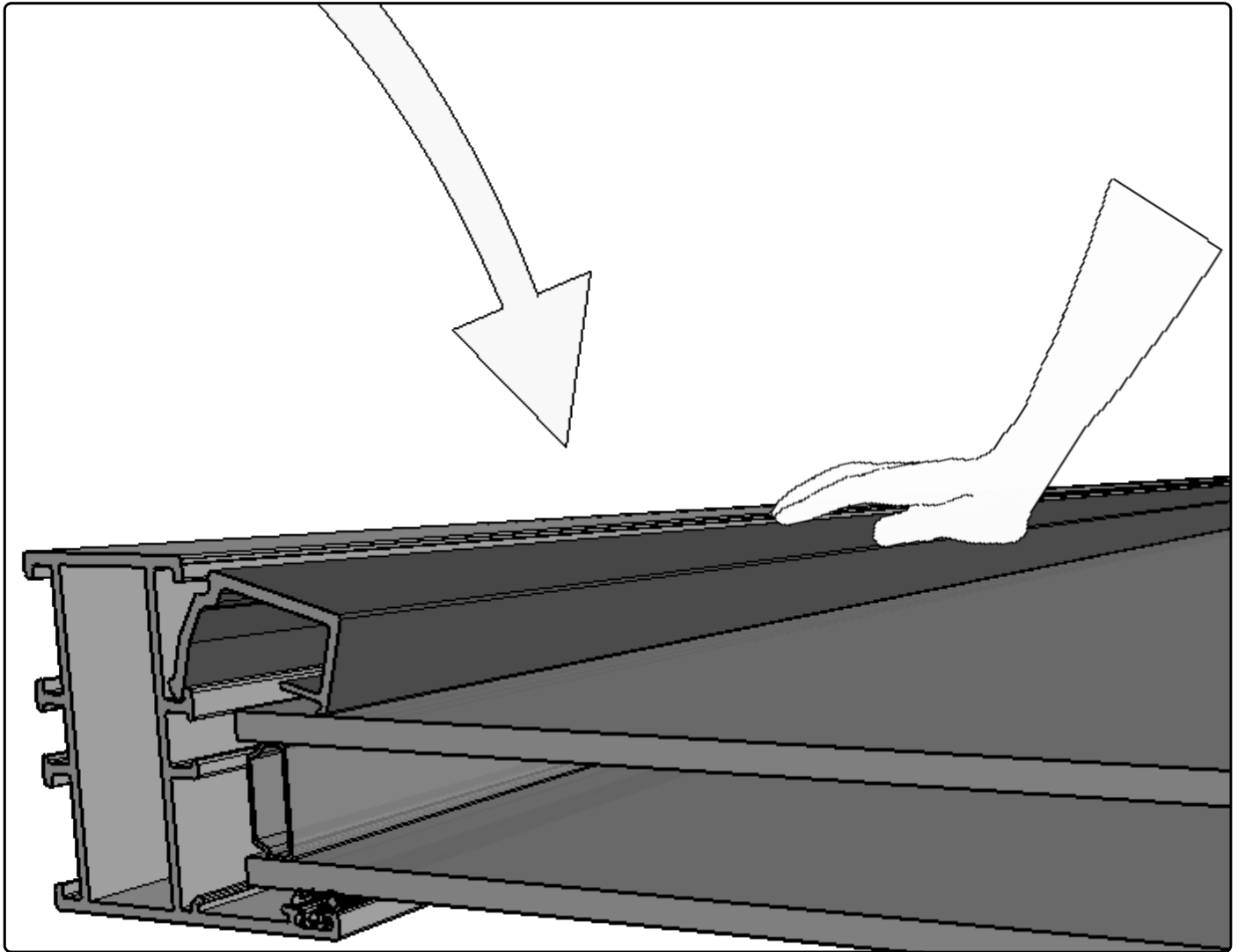

V

Plan: 13-C A51-15-7016  
Positions:

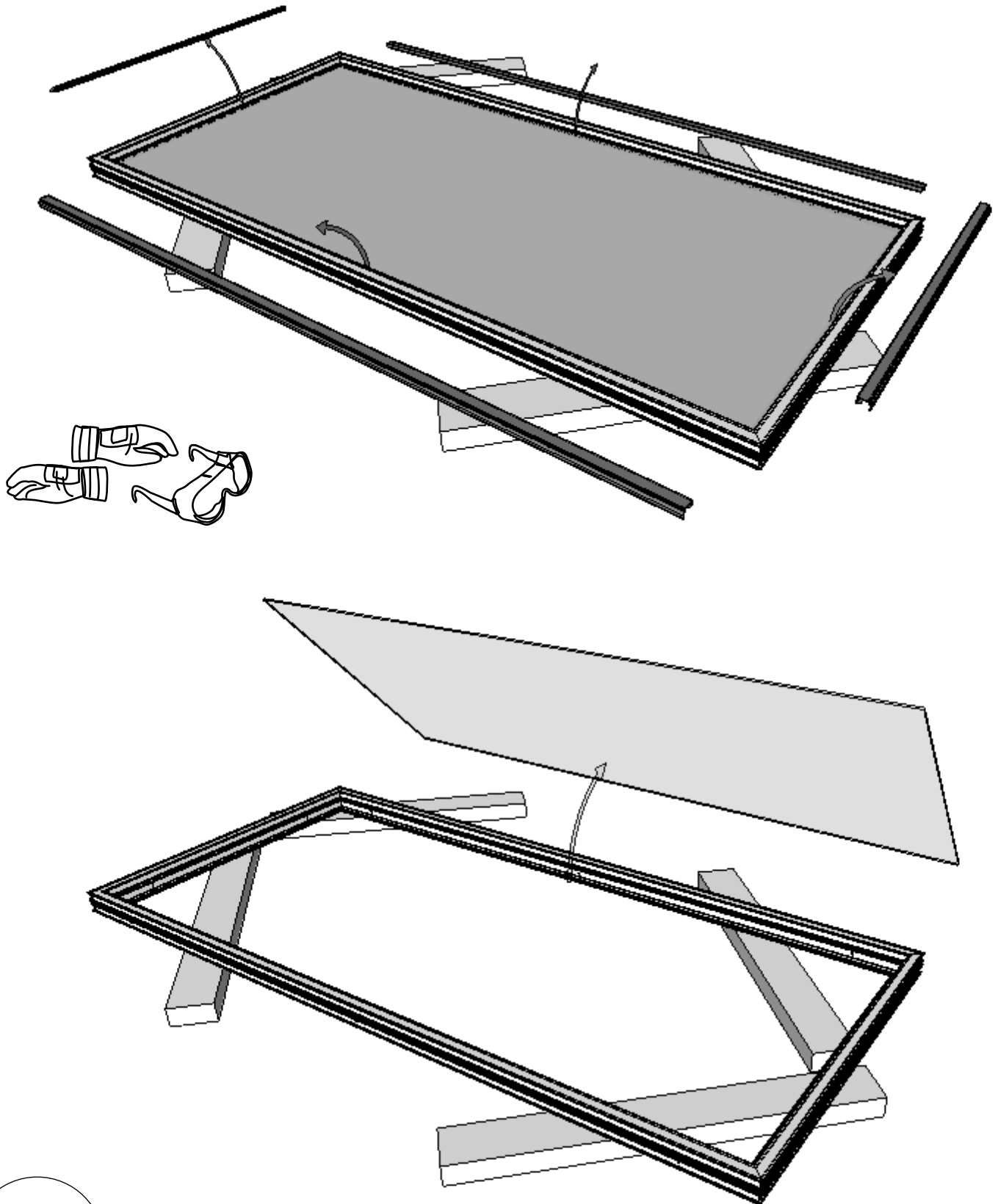

VI

Plan: 13-C A51-15-7016

Positions:

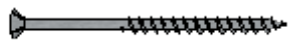

QKRPP3\_5x50Zn

SLA

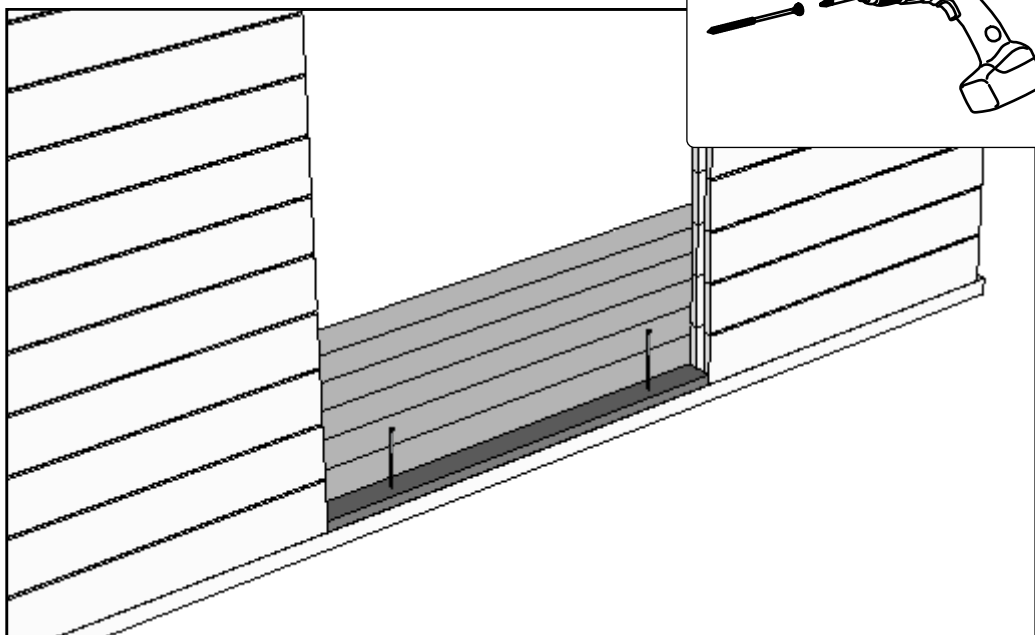
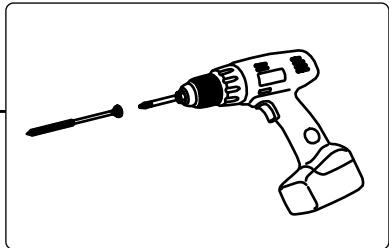
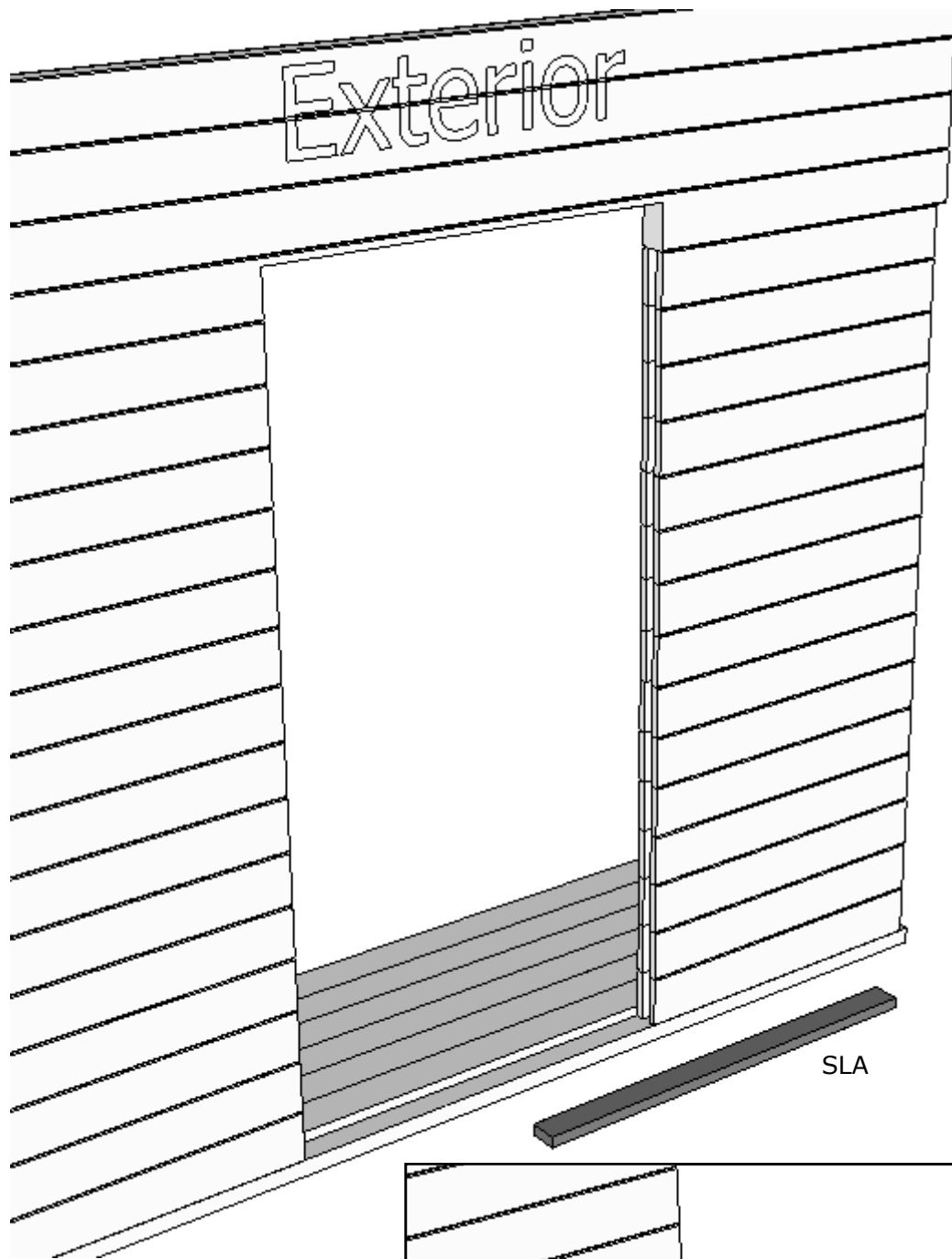

VII

Plan: 13-C A51-15-7016  
Positions: QP40X30X1128MU

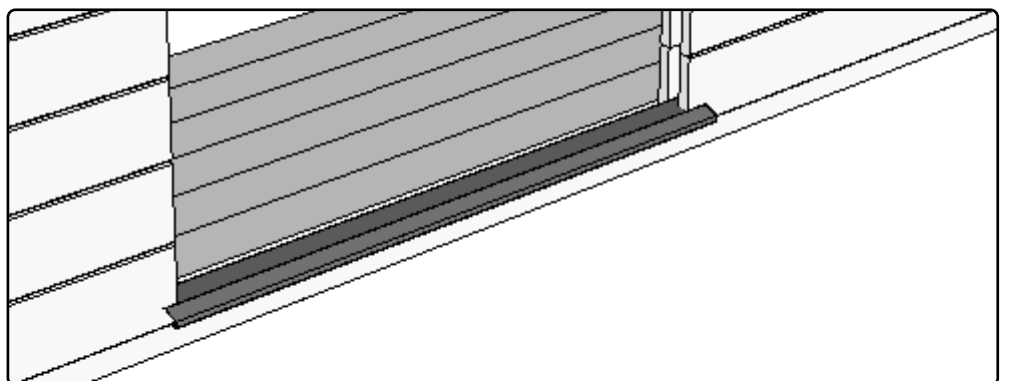
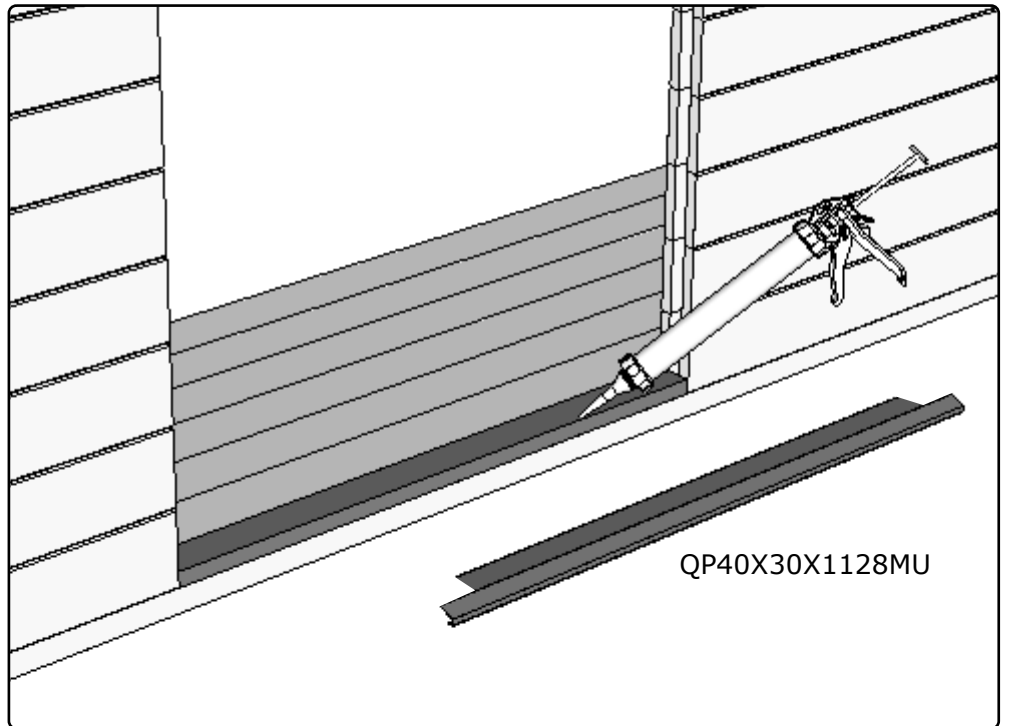
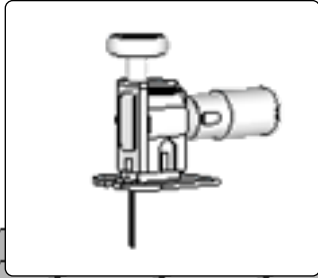

VII

Plan: 13-C A51-15-7016

Positions:



QKRPP3-5x50Zn

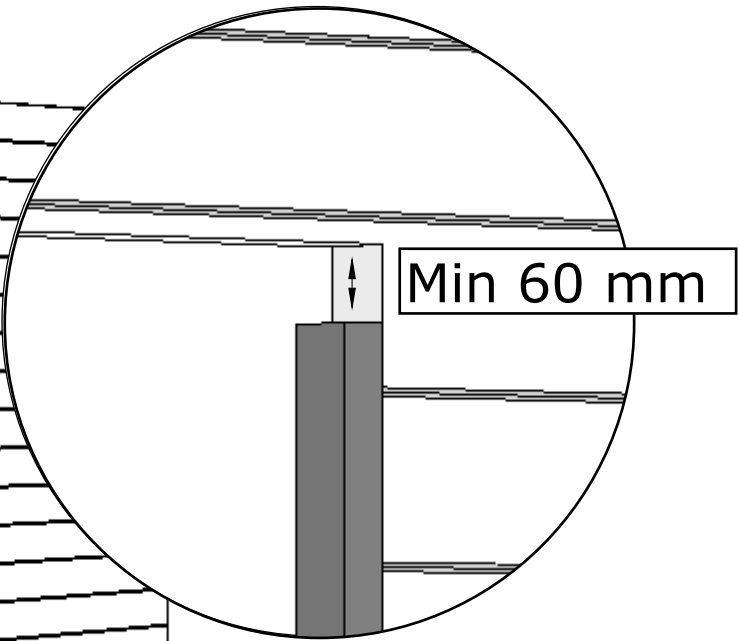
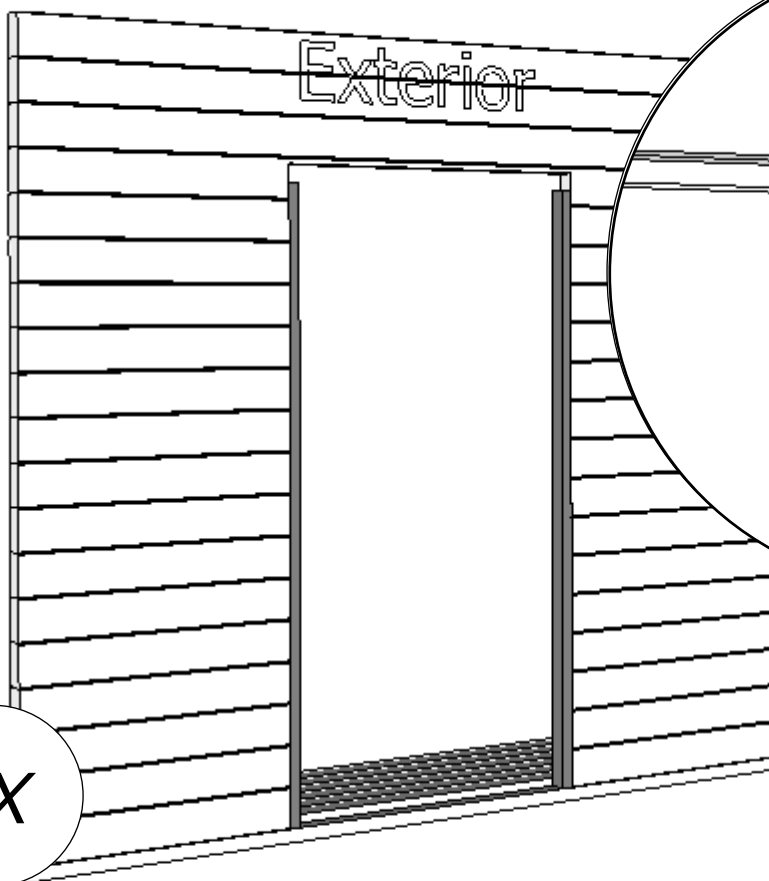
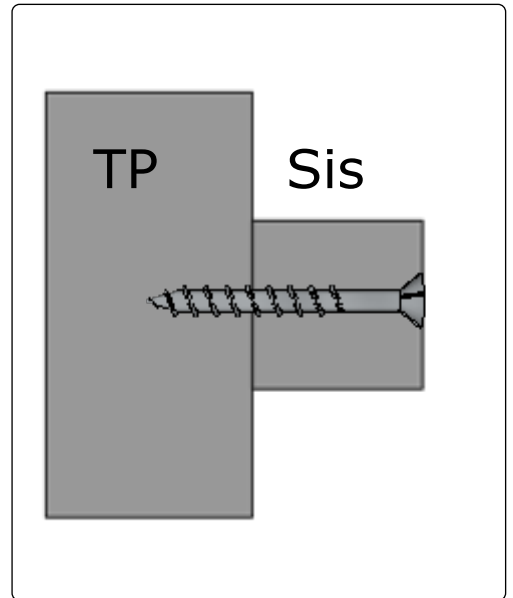
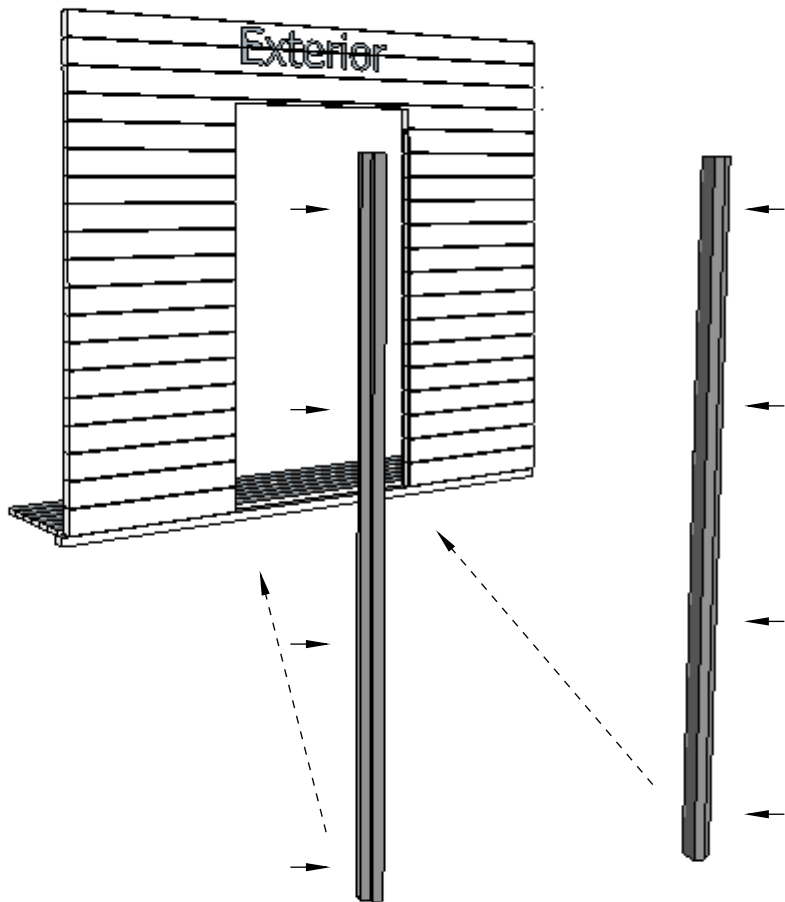

Min 60 mm

IX



Plan: 13-C A51-15-7016

Positions:

 QKRYP5x60Zn

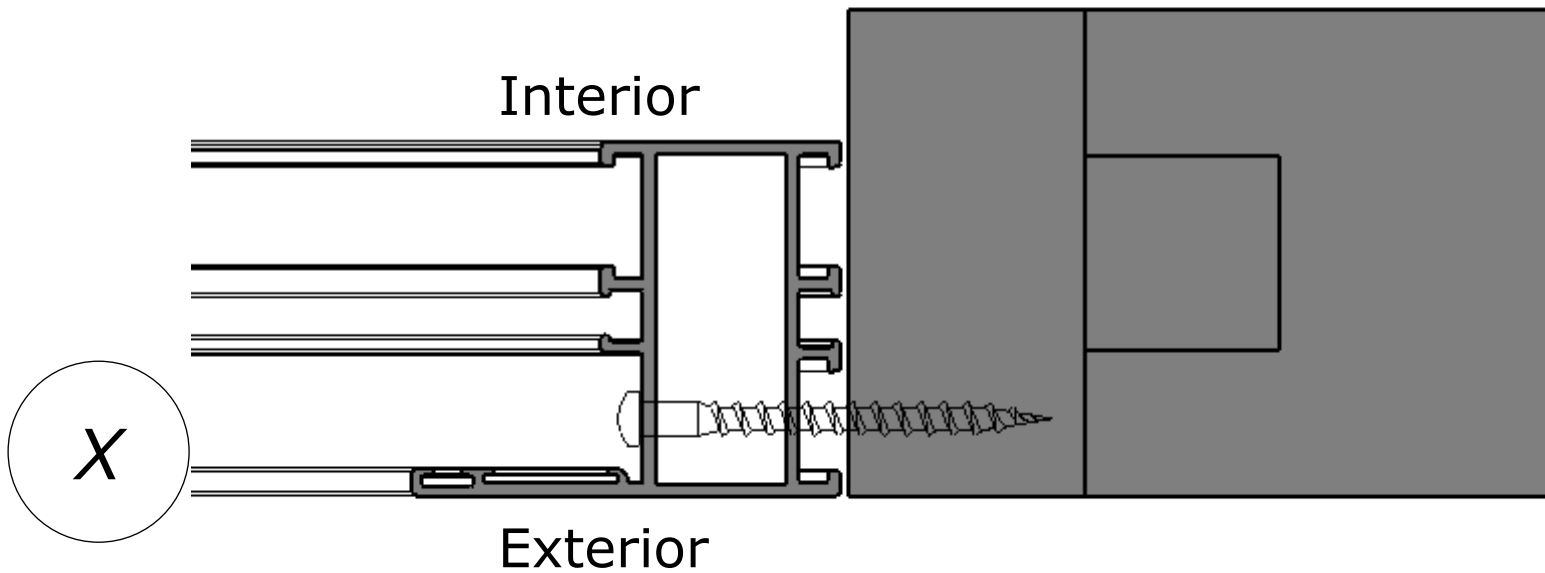
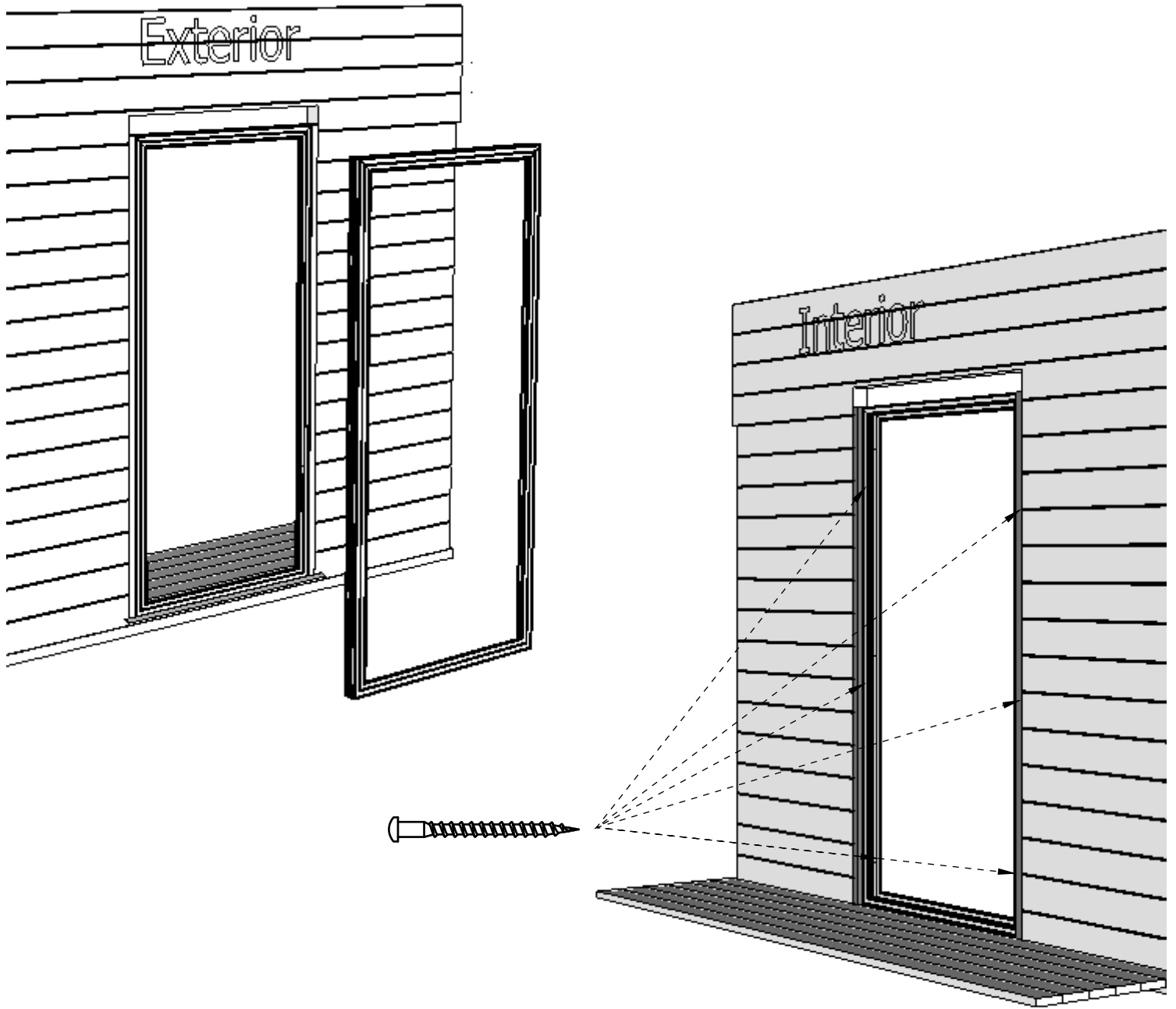

Plan: 13-C A51-15-7016

Positions:

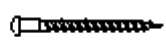

QKRYP5x60Zn

SIS

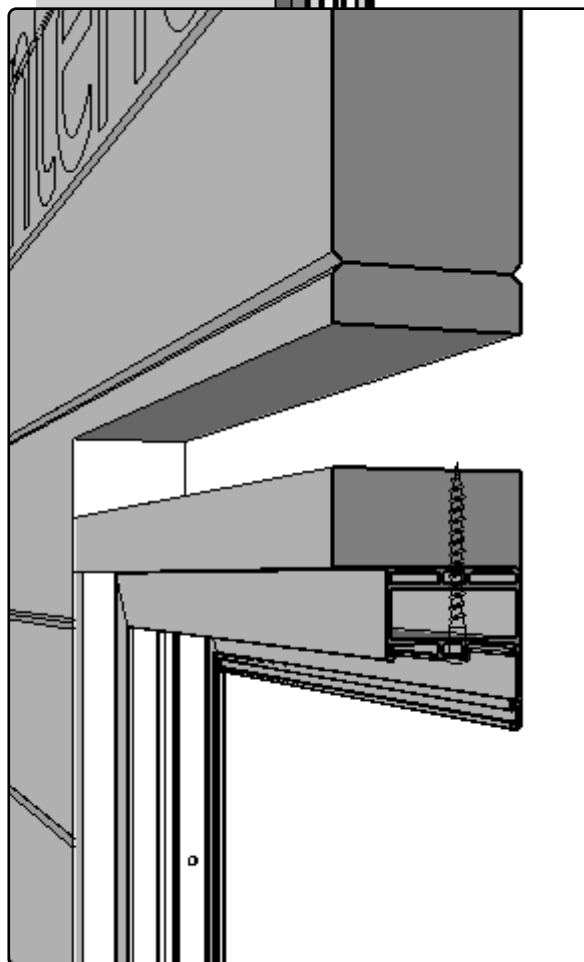
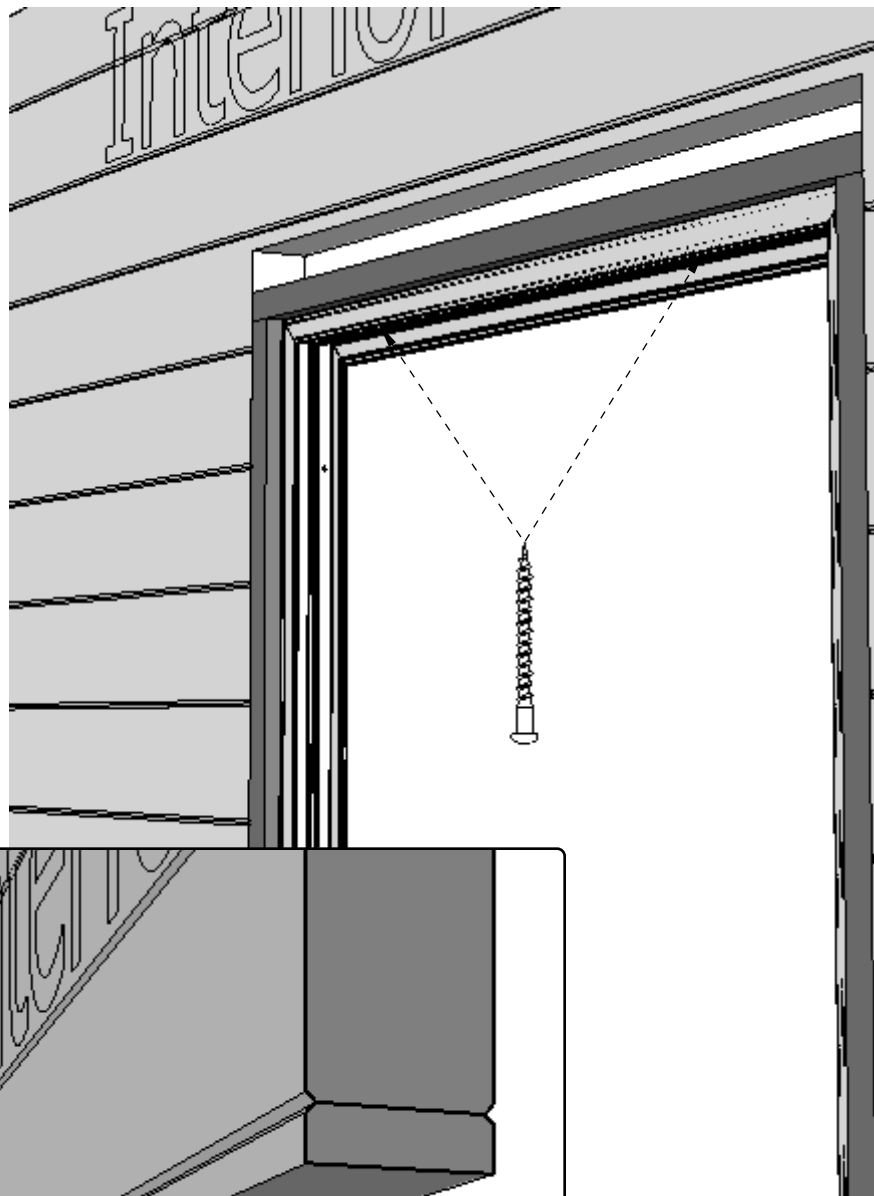
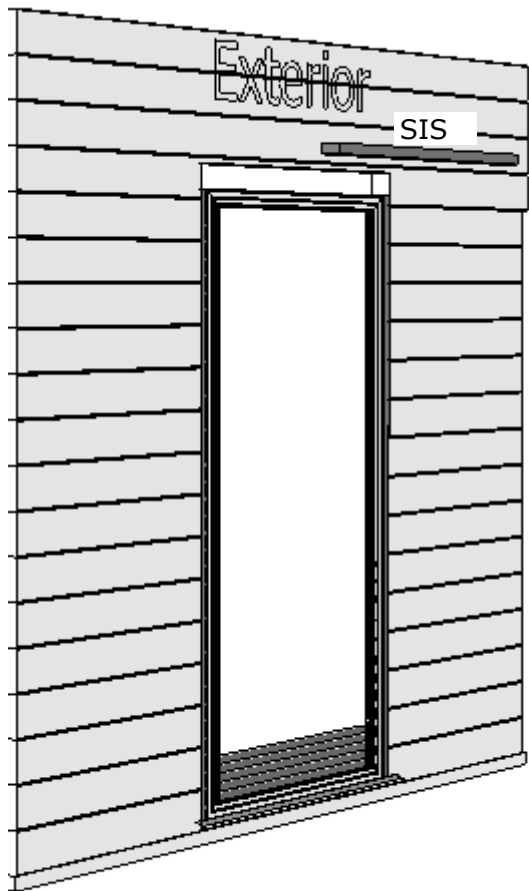

XI

Plan: 13-C A51-15-7016

Positions:

QT140-1

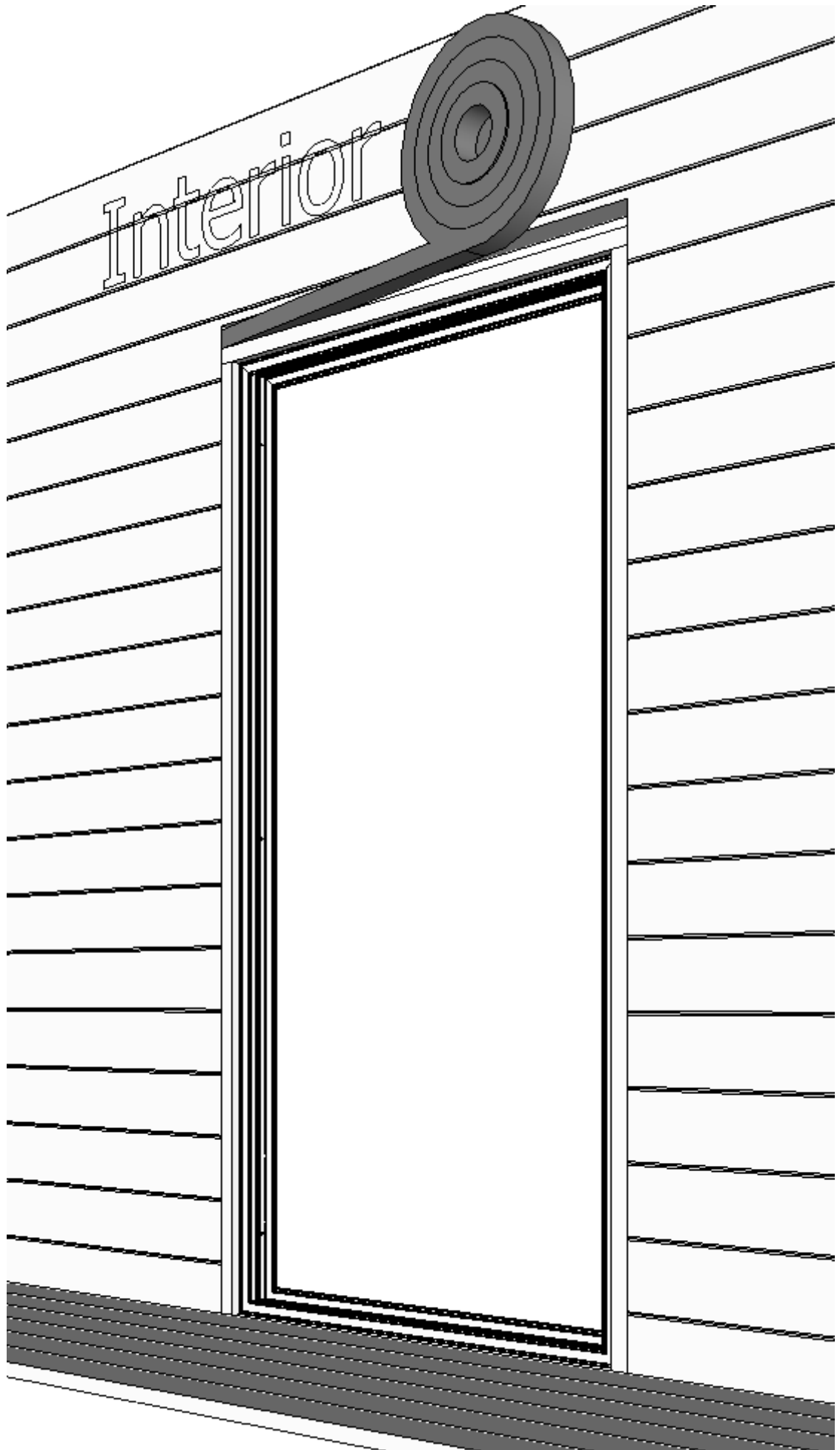

*XII*

Plan: 13-C A51-15-7016

Positions: COB



QKRPP3-5x50Zn

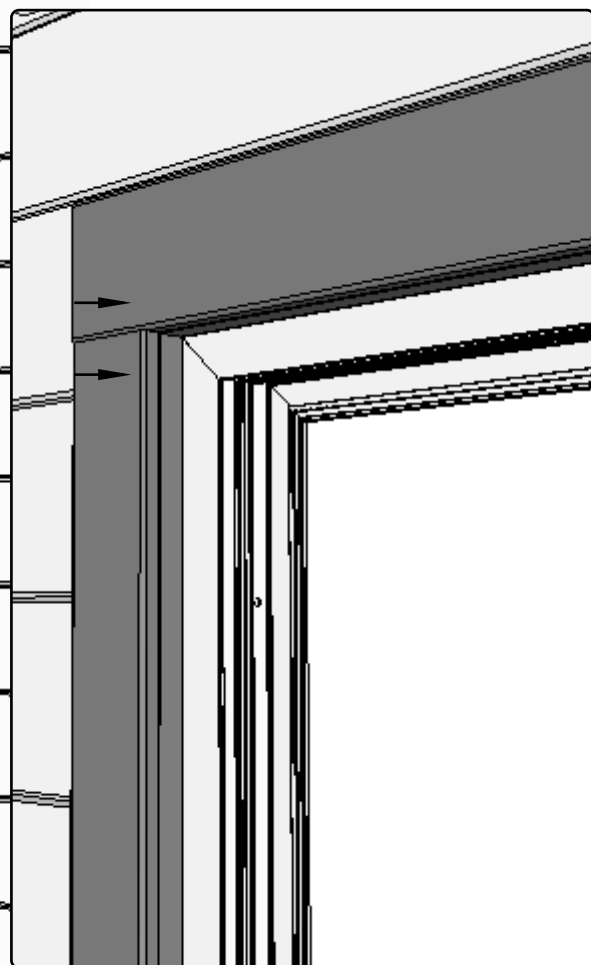

*XII*

Exterior

3

2

Wind protective tape

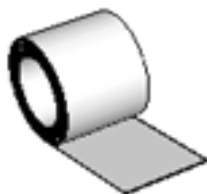

Not included

1

1

Plan: 13-C A51-15-7016

Positions: COB

— QKRPP3-5x50Zn

Exterior

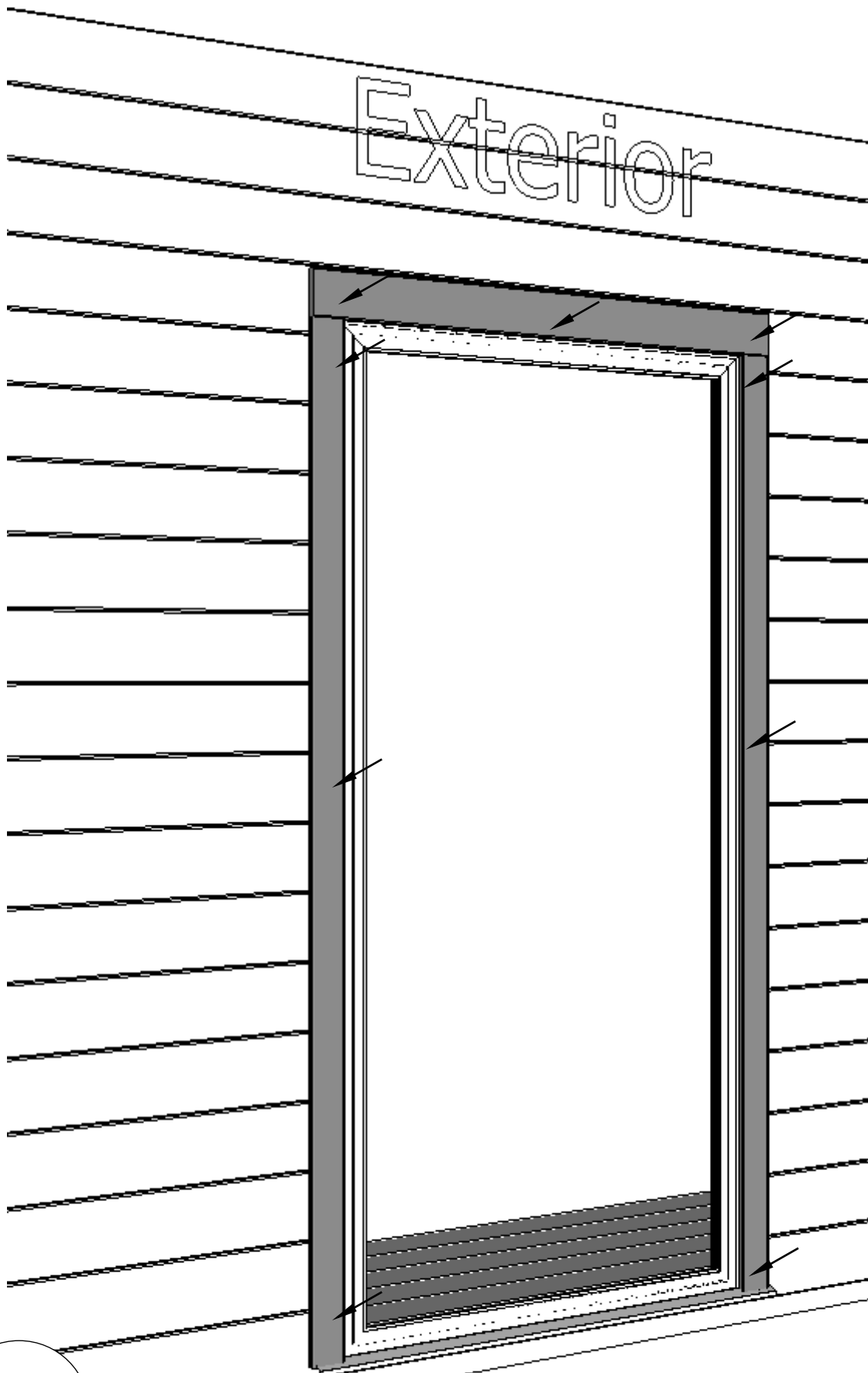

XV

Plan: 13-C A51-15-7016

Positions: COB



QKRPP3-5x50Zn

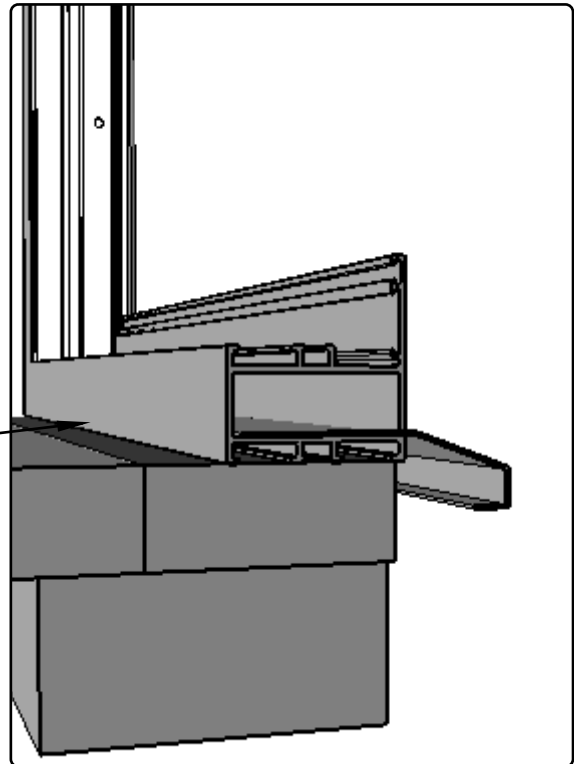
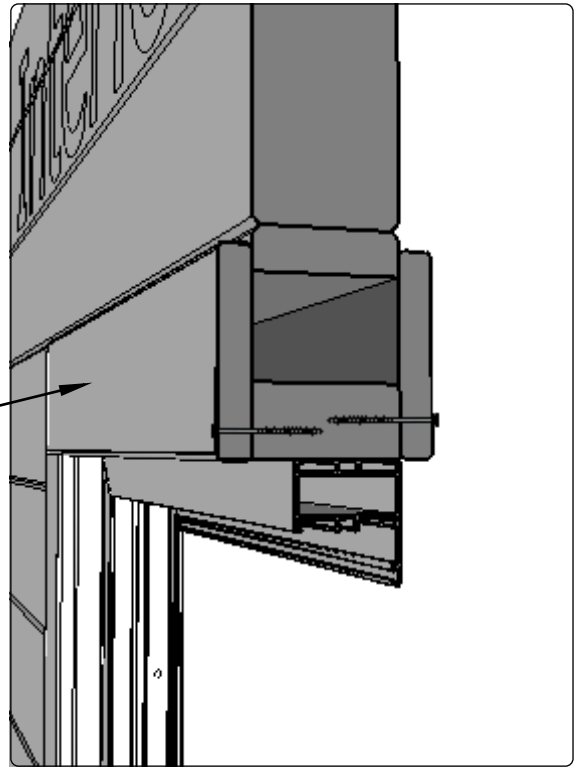
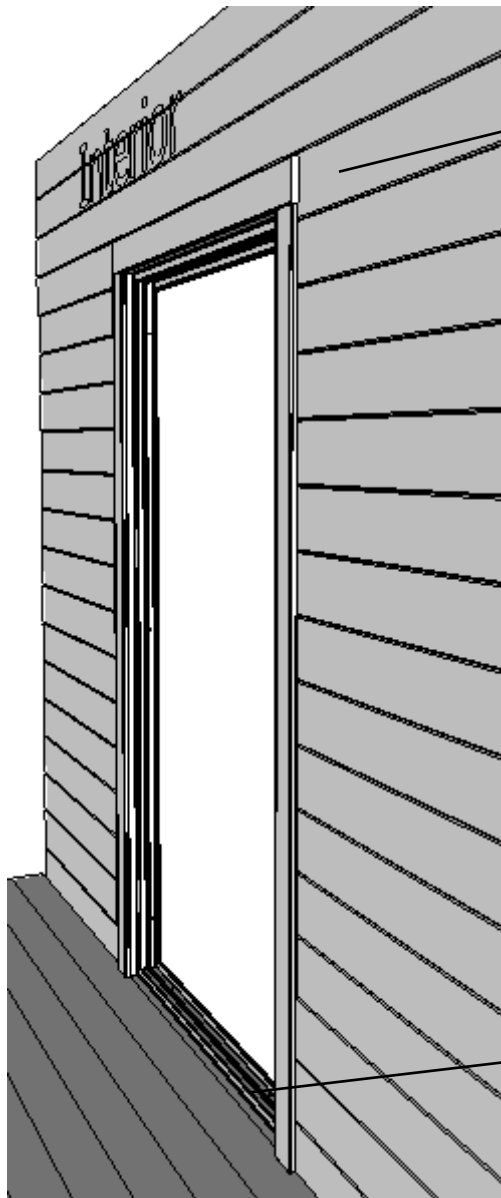

Plan: 13-C A51-15-7016  
Positions:

