

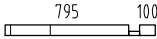









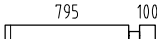
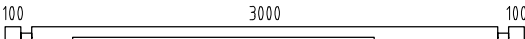

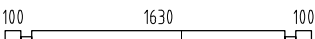

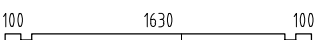
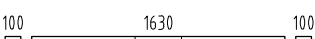

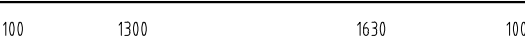

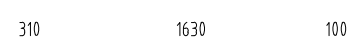

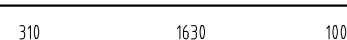
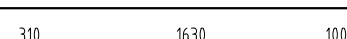
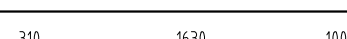
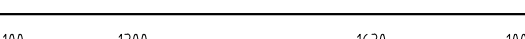
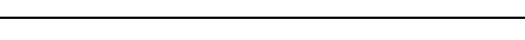
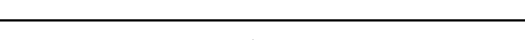
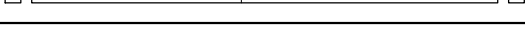
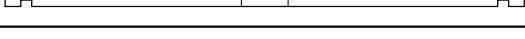

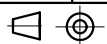
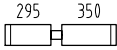
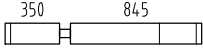

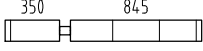
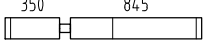
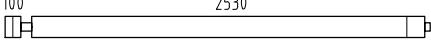
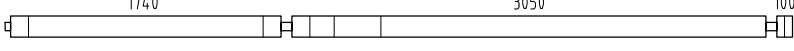
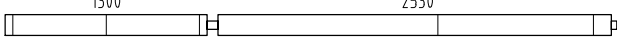
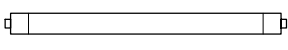
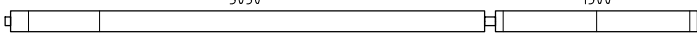
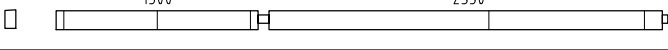
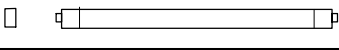
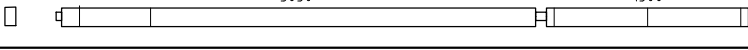
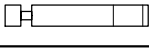
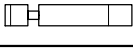
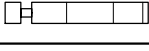
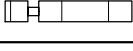
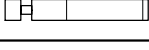
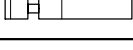
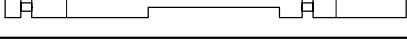
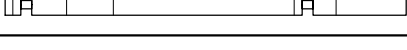
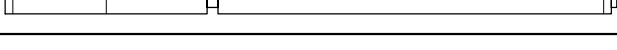
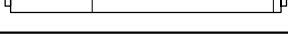
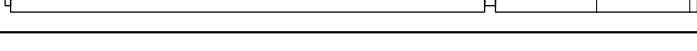
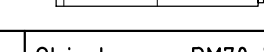
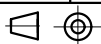
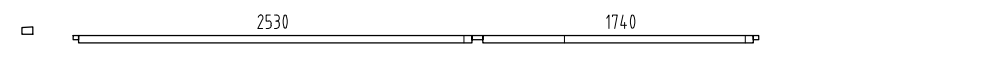
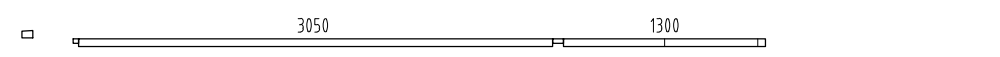
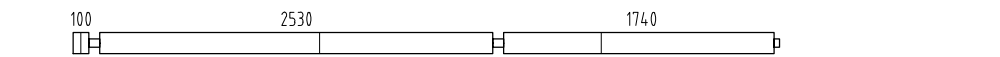

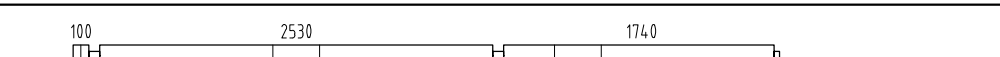
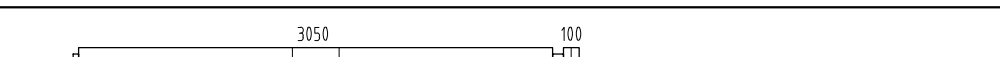

Pos	SPECIFICATION-STÜCKLISTE-NOMENCLATURE-ELEMENTI-ESPECIFICACIÓN PM70-7933	Pcs	Profile (mm)	Length (mm)
001		1	70x68	435
002		1	70x68	965
003		15	70x135	435
004		15	70x135	965
005		1	70x135	3340
006		1	70x135	3340
009		1	70x68	270
010		1	70x68	1970
011		15	70x135	270
012		8	70x135	1970
013		7	70x135	1970
014		1	70x135	3340
015		2	70x135	3340
016		1	70x68	315
017		1	70x68	2180
018		15	70x135	315
019		4	70x135	2180
020		7	70x135	2180
021		4	70x135	2180
022		1	70x135	3340
023		1	70x68	3340
024		8	70x135	3340
025		8	70x135	3340
026		1	70x135	3340
027		16	70x135	465

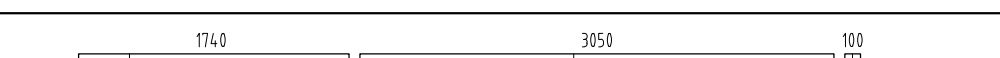
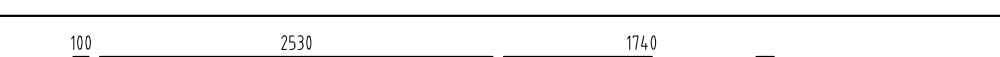
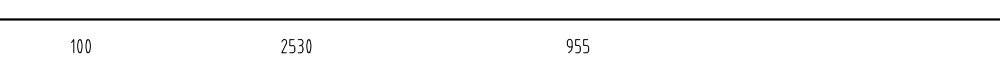
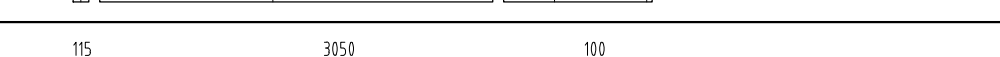
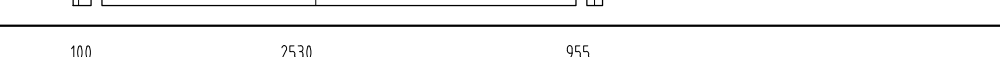

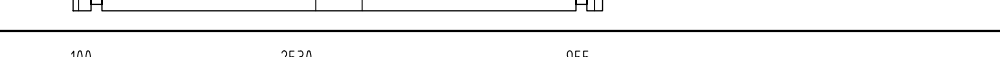
Pos	SPECIFICATION-STÜCKLISTE-NOMENCLATURE-ELEMENTI-ESPECIFICACIÓN PM70-7933	Pcs	Profile (mm)	Length (mm)
028		16	70x135	715
029		5	70x135	1265
030		16	70x135	435
031		7	70x135	1265
032		4	70x135	1265
033		1	70x135	2735
034		1	70x135	5065
035		1	70x135	3935
036		1	70x135	1810
037		1	70x135	4455
038		1	70x120	3935
039		1	70x120	1810
040		1	70x120	4455
041		5	70x135	920
042		5	70x135	815
043		7	70x135	920
044		7	70x135	815
045		3	70x135	920
046		3	70x135	815
047		1	70x135	2580
048		1	70x135	2580
049		1	70x135	3935
050		1	70x135	1810
051		1	70x135	4455
052		1	70x49	1335

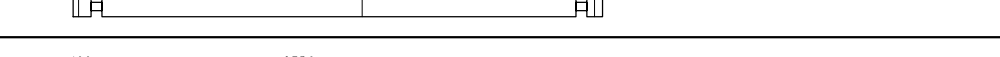
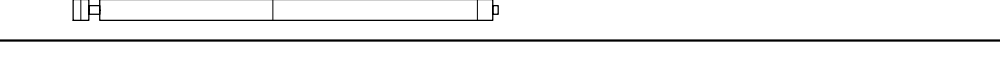
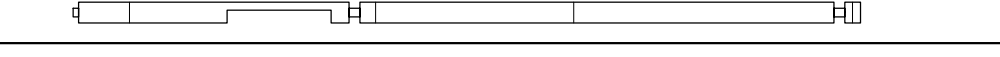
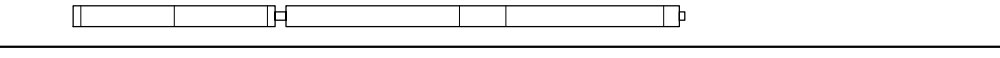
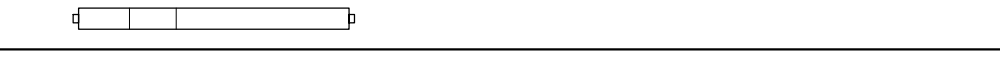
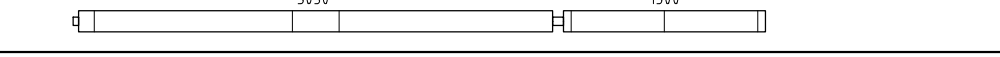
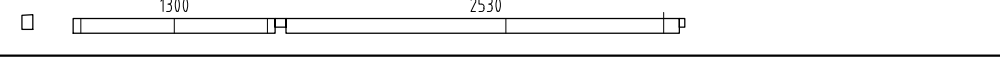



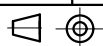



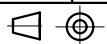

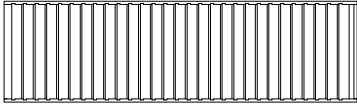

















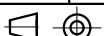





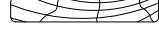









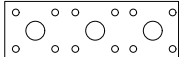
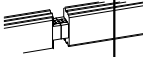

Pos	SPECIFICATION-STÜCKLISTE-NOMENCLATURE-ELEMENTI-ESPECIFICACIÓN PM70-7933	Pcs	Profile (mm)	Length (mm)
053		1	70x49	4410
054		1	70x49	4455
055		1	70x135	4545
056		1	70x135	3255
057		3	70x135	2735
058		3	70x135	5065
059		4	70x135	4545
060		5	70x135	3255
061		2	70x135	2735
062		2	70x135	5065
063		1	70x135	4545
064		1	70x135	3725
065		1	70x135	3405
066		2	70x135	3725
067		2	70x135	3405
068		1	70x135	3725
069		1	70x135	3405
070		1	70x135	2735
071		1	70x135	5065
072		1	70x135	3935
073		1	70x135	1810
074		1	70x135	4455
075		1	70x95	3935
076		1	70x95	1810
077		1	70x95	4455



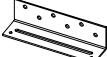









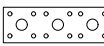



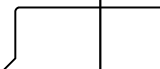

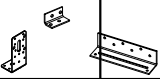

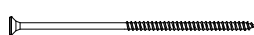



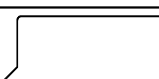



Pos	SPECIFICATION-STÜCKLISTE-NOMENCLATURE-ELEMENTI-ESPECIFICACIÓN PM70-7933	Pcs	Profile (mm)	Length (mm)
W1-1		1		
W2-1		1		
W3-1		1		
W4-1		1		
AR1	Foundation- Fundament- Fondation- Fondazione- Vigas de cimentación 	2	95x45	2630
AR2	Foundation- Fundament- Fondation- Fondazione- Vigas de cimentación 	2	95x45	4960
AR3	Foundation- Fundament- Fondation- Fondazione- Vigas de cimentación 	2	95x45	1305
AR4	Foundation- Fundament- Fondation- Fondazione- Vigas de cimentación 	2	95x45	2940
AR21	Foundation- Fundament- Fondation- Fondazione- Vigas de cimentación 2 	4	70x45	2940
AR31	Foundation- Fundament- Fondation- Fondazione- Vigas de cimentación- NAT 	7	70x45	2465
AR32	Foundation- Fundament- Fondation- Fondazione- Vigas de cimentación- NAT 	7	70x45	1670
AR33	Foundation- Fundament- Fondation- Fondazione- Vigas de cimentación- NAT 	7	70x45	2985
CoB1	Covering board- Deckbrett- Madrier de couverture- Tavola di copertura- Listón de cubierta 	10	70x28	2050
CoB2	Covering board- Deckbrett- Madrier de couverture- Tavola di copertura- Listón de cubierta 	4	70x16	600
CoB3	Covering board- Deckbrett- Madrier de couverture- Tavola di copertura- Listón de cubierta 	8	70x16	2049
CoB4	Covering board- Deckbrett- Madrier de couverture- Tavola di copertura- Listón de cubierta 	2	95x28	1109
CoB5	Covering board- Deckbrett- Madrier de couverture- Tavola di copertura- Listón de cubierta 	3	95x28	2010
CoB6	Covering board- Deckbrett- Madrier de couverture- Tavola di copertura- Listón de cubierta 	2	95x16	740
CoB7	Covering board- Deckbrett- Madrier de couverture- Tavola di copertura- Listón de cubierta 	1	19x95	740
CoB8	Covering board- Deckbrett- Madrier de couverture- Tavola di copertura- Listón de cubierta 	3	95x16	2010
CoB9	Covering board- Deckbrett- Madrier de couverture- Tavola di copertura- Listón de cubierta 	1	95x16	1110

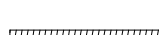



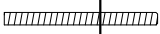





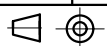

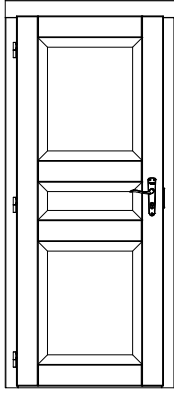

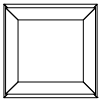
Pos	SPECIFICATION-STÜCKLISTE-NOMENCLATURE-ELEMENTI-ESPECIFICACIÓN PM70-7933	Pcs	Profile (mm)	Length (mm)
	žaluzii- Louver- das Lattenfenster- la persienne- la persiana 600 x 2100 mm 	4		
EaE1	Eave edging- Dachrandbrett- Madrier en bordure du toit- Tavola bordo tetto- Tabla de valadizo 	2	70x28	4800
EaE2	Eave edging- Dachrandbrett- Madrier en bordure du toit- Tavola bordo tetto- Tabla de valadizo 	2	70x28	5400
EaE3	Eave edging- Dachrandbrett- Madrier en bordure du toit- Tavola bordo tetto- Tabla de valadizo 	1	120x28	4800
EaE4	Eave edging- Dachrandbrett- Madrier en bordure du toit- Tavola bordo tetto- Tabla de valadizo 	1	120x28	5400
RoR1	Rafter- Sparre- Chevron- Trave- Cabrio 	24	140x44	4573
RoR2	Rafter- Sparre- Chevron- Trave- Cabrio 	6	140x44	5100
Sis1	Side slat- Randleiste- Baguette en bordure- Listón de borde- Listello bordo 	10	34x70	2050
Sis2	Side slat- Randleiste- Baguette en bordure- Listón de borde- Listello bordo 	2	34x70	600
Sis3	Side slat- Randleiste- Baguette en bordure- Listón de borde- Listello bordo 	2	34x70	1038
Sis4	Side slat- Randleiste- Baguette en bordure- Listón de borde- Listello bordo 	1	34x70	668
Sis5	Side slat- Randleiste- Baguette en bordure- Listón de borde- Listello bordo 	3	34x70	1938
Sla1	Slat- Leiste- Baguette- Listello- Listón 	2	28x70	1039
Sla2	Slat- Leiste- Baguette- Listello- Listón 	3	28x70	1939
TP1	Tender post- Tenderleiste- T-poste- Rinforzo- Refuerzo 	2	28x28	550
TP2	Tender post- Tenderleiste- T-poste- Rinforzo- Refuerzo 	8	28x28	2050
2FB3-1	Floor board- Fussbodenbrett- Madrier du plancher - Tavola pavimento- Tabla de suelo 	66+1	114x28	2994
RB2-1	Roof board- Dachbrett- Madrier du toit- Tavola tetto- Tabla de tejado 	52+1	89x19	5400
	Object name PM70-7933	Page		5/8

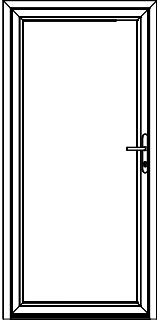

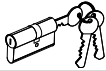
Pos	SPECIFICATION-STÜCKLISTE-NOMENCLATURE-ELEMENTI-ESPECIFICACIÓN PM70-7933		Pcs	Profile (mm)	Length (mm)
RB2-2	Roof board- Dachbrett- Madrier du toit- Tavola tetto- Tabla de tejado		52+1	89x19	4800
TB3-1	Ceiling board- Dachbodenbrett- Madrier du Grenier- Tavola soffitta- Tabla de techo		16+2	95x16	5400
TB3-2	Ceiling board- Dachbodenbrett- Madrier du Grenier- Tavola soffitta- Tabla de techo		16+2	95x16	4800
TB3-3	Ceiling board- Dachbodenbrett- Madrier du Grenier- Tavola soffitta- Tabla de techo		64+2	95x16	1300
FIB3-1	Floor beading- Fussbodenleiste- Baguette du plancher- Listello pavimento- Listón de suelo		10	19x45	2360
QT140-1	Seal- Dichtung- Joint d'isolation- Guarnizione- Burlete- QT140		4	A51-13 U51-5 LU59-5	2500
StS1	Stabilizing stick- Stabilisierungsstock- Baton équilibrant- Bastone stabilizzatore- Palo estabilizador		73	16x16	360
StS2	Stabilizing stick- Stabilisierungsstock- Baton équilibrant- Bastone stabilizzatore- Palo estabilizador		3	16x16	345
StS3	Stabilizing stick- Stabilisierungsstock- Baton équilibrant- Bastone stabilizzatore- Palo estabilizador		3	16x16	290
StS4	Stabilizing stick- Stabilisierungsstock- Baton équilibrant- Bastone stabilizzatore- Palo estabilizador		3	16x16	270
StS5	Stabilizing stick- Stabilisierungsstock- Baton équilibrant- Bastone stabilizzatore- Palo estabilizador		3	16x16	225
StS6	Stabilizing stick- Stabilisierungsstock- Baton équilibrant- Bastone stabilizzatore- Palo estabilizador		1	16x16	210
StS7	Stabilizing stick- Stabilisierungsstock- Baton équilibrant- Bastone stabilizzatore- Palo estabilizador		3	16x16	180
QKRKK 8x30Zn	Bolt -Schloss-schraube -Boulon- Bullone- Perno- 8x30mm KSKR		2		
QLI2 5x1_0	Connection tape -Verbindungsband für Bohlen -Ruban de connection -Nastro di connessione- Cinta de conexión 1x25x60 mm		20		
QLIUY-1	Door fittings- Türbeschlag- Ferrure- Ferramenta porta- Manilla (puerta)- QLIUY-1		2	U71-1V	
QVKA	Door fittings- Türbeschlag- Ferrure- Ferramenta porta- Manilla (puerta)- QVKA		2	U71-1V	
QNU20 x20x40	L-iron- Winkel- Angle -Angolo- Angulo 20x20x40		48	AR1, AR2,.../001,002...	
QNU35x3 5x130Zn	L-iron- Winkel- Angle -Angolo- Angulo 35x35x130 EM VN353590		6		
QNU50x6 5x130Zn	L-iron- Winkel- Angle -Angolo- Angulo- QNU50x65x130Zn		2		
QNA2 2x50Zn	Nail- Nagel- Clou- Chiodo- Clavo- 2.5x50mm		1300	RB2-1 RB2-2	
QNA3 x70Zn	Nail- Nagel- Clou- Chiodo- Clavo- 3x70mm		700	2FB3-1	





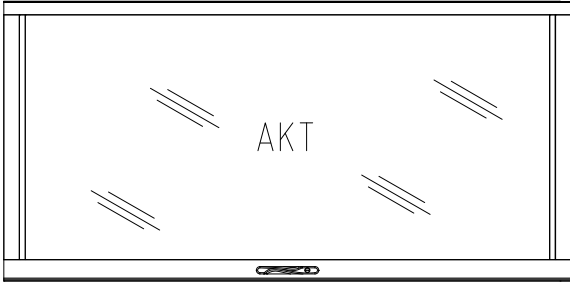
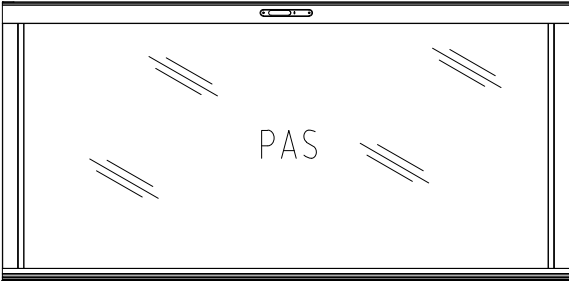
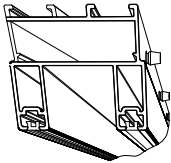
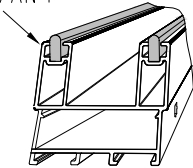
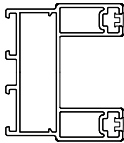

Pos	SPECIFICATION-STÜCKLISTE-NOMENCLATURE-ELEMENTI-ESPECIFICACIÓN PM70-7933	Pcs	Profile (mm)	Length (mm)
QNA4 x40Zn	Nail- Nagel- Clou- Chiodo- Clavo- 4x40mm- EM72801		160	
QKRPP3 _5x50Zn	Screw- Schraube- Vis- Vite- Tornillo- 3.5x50mm		1100	CoB1... TP1... EaE1... WB1... Sis1... TB3
QKRPP4 _5x70Zn	Screw- Schraube- Vis- Vite- Tornillo- 4.5x70mm		200	RoR2
QKRK K4_8 x28MU	Screw- Schraube- Vis- Vite- Tornillo- 4.8x28mm MU		150	
QKRYP5 x40ZnTX	Screw- Schraube- Vis- Vite- Tornillo- 5x40mm		200	
QKRYP 5x40Zn	Screw- Schraube- Vis- Vite- Tornillo- 5x40mm ZnY		48	LU59-5 P-7016
QKRYP 5x60Zn	Screw- Schraube- Vis- Vite- Tornillo- 5x60mm ZnY		18	A51-13 U51-5
QKRPP 6x160 ZnTX-1	Screw- Schraube- Vis- Vite- Tornillo- 6x160mm TX-1		130	AR1, AR2,... RoR1
QP40x30 x1109MU	Water gutter- Wasserleiste- Rejet d'eau- Protección de lluvia- Protezione dalla pioggia- QP40x30x1109		1	
QP40x30 x2010MU	Water gutter- Wasserleiste- Rejet d'eau- Protección de lluvia- Protezione dalla pioggia- QP40x30x2010		3	
QP40x3 0x740MU	Water gutter- Wasserleiste- Rejet d'eau- Protección de lluvia- Protezione dalla pioggia- QP40x30x740		1	
QP151 x52_4 x2000MU	Water gutter- Wasserleiste- Rejet d'eau- Protección de lluvia- Protezione dalla pioggia- QP151x52_4x2000MU		18	
QKRYP8 x260Zn	Screw- Schraube- Vis- Vite- Tornillo- 8x260mm ZnY		50	
KL1	Threaded rod- Gewindestangen- Barre filté- Asta filettata- Varilla roscada M10		4	2000
KL2	Threaded rod- Gewindestangen- Barre filté- Asta filettata- Varilla roscada M10		2	600
KL3	Threaded rod- Gewindestangen- Barre filté- Asta filettata- Varilla roscada M10		2	440
KL4	Threaded rod- Gewindestangen- Barre filté- Asta filettata- Varilla roscada M10		4	305
KL5	Threaded rod- Gewindestangen- Barre filté- Asta filettata- Varilla roscada M10		4	280
KL6	Threaded rod- Gewindestangen- Barre filté- Asta filettata- Varilla roscada M10		4	234
QMUk K10ZN	Nut- Schraubenmutter- Écrou- Dado- Tuerca- M10mm		16	
QSE10 X30ZN	Washer- Dichtscheibe- Joint- Rondella- Arandela- 10x30mm		16	
QMUJ 10ZN	Extension nut- Verlängerungsmutter- Écrou rallonge- Dado di prolunga- Tuerca de extensión- JM10		4	
QMUP L10ZN	Top nut- Schweissmutter mit Flansch- Ecrou a souder- Dado a saldare- Tuerca soldable- M10		16	

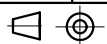

Pos	SPECIFICATION-STÜCKLISTE-NOMENCLATURE-ELEMENTI-ESPECIFICACIÓN PM70-7933	Pcs	Profile (mm)	Length (mm)
U71-1V	Door - Tür - Porte - Porta-Puerta 835x2023   735x1954mm	2		
A51-13 V-7016	Window - Fenster - Fenetre - Finestra-Ventana 600x600   500x500mm	1		
U51-5 P-7016	Door - Tür - Porte - Porta-Puerta 990x2050   874x1986mm	1		
QLY- LWB02	Cylinder- Zylinderschloss- Serrure a mortaiser- Serratura a cilindro- Bombin- QLY-LWB02 	1		
QLY-A CWKS92	Door fittings- Türbeschlag- Ferrure- Ferramenta porta- Manilla (puerta)- QLY-ACWKS92 	1		
QLY-A CMAS29	Window fittings- Fenstergriff- Poigne de la fenêtre- Maniglia finestra- Manilla- QLY-ACMAS29 	1		
QLY-A CMAS33	Window fittings- Fenstergriff- Poigne de la fenêtre- Maniglia finestra- Manilla- QLY-ACMAS33 	1		
QLY-A CVG45Z	Window fittings- Fenstergriff- Poigne de la fenêtre- Maniglia finestra- Manilla- QLY-ACVG45Z 	1		
 	Object name PM70-7933		Page	8/8

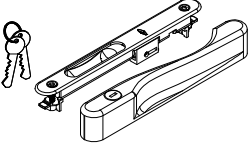
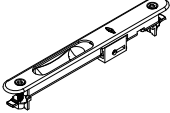
Pos	SPECIFICATION-STÜCKLISTE-NOMENCLATURE-ELEMENTI-ESPECIFICACIÓN LU59-5P-7016	Pcs	Profile (mm)	Length (mm)
A-2		3	916x42	1968
B-2		3	916x42	1968
SL8110 S-1		3	59x50	1870
SL8110 S-2	<p data-bbox="550 1211 715 1240">QLY-VG53/AN 1</p> 	3	59x50	1870
SL8110 S-3		6	59x50	2050
QLY-SL076S-1		3		1870

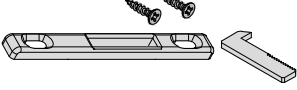
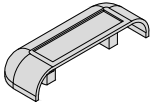
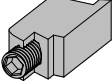
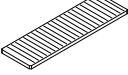
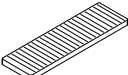

Pos	SPECIFICATION-STÜCKLISTE-NOMENCLATURE-ELEMENTI-ESPECIFICACIÓN LU59-5P-7016	Pcs	Profile (mm)	Length (mm)
QLY- ACSL243		3		
QLY- ACSL240		3		
QLY- ACSL813A		3		
QLY- ACSL246		3		
QLY- ACSL024Z		3		
QLY- ALI170		48		
QPL20x 100x2PET		24		
QPL20x 100x3PET		24		
QSE3x8_5	Seal- Dichtung- Joint d'isolation- Guarnizione- Burlate		9	
QG-2	Hole plug- Abdeckkappe- Cache-vis- Tappi in legno- Embellecedor		9	

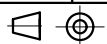

H = 1.500 m
TOTAL: 21.79 m²

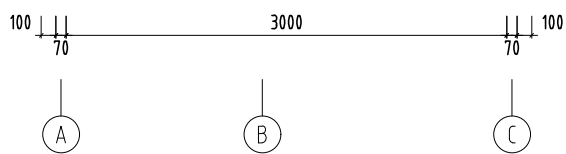
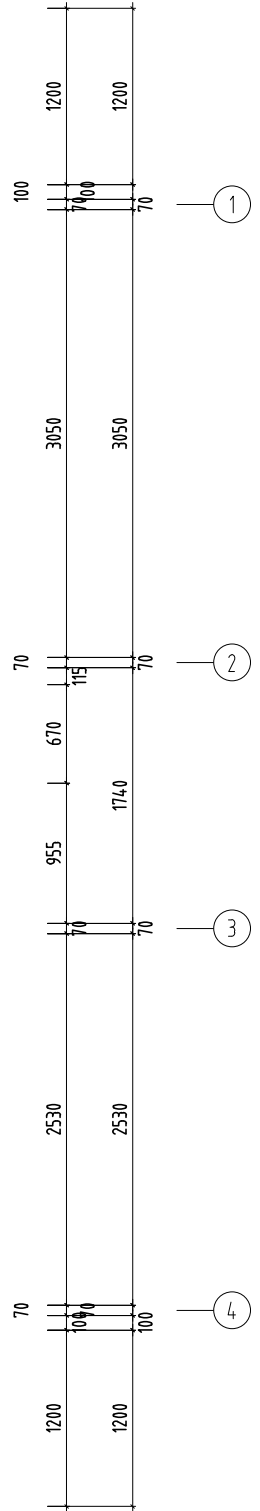
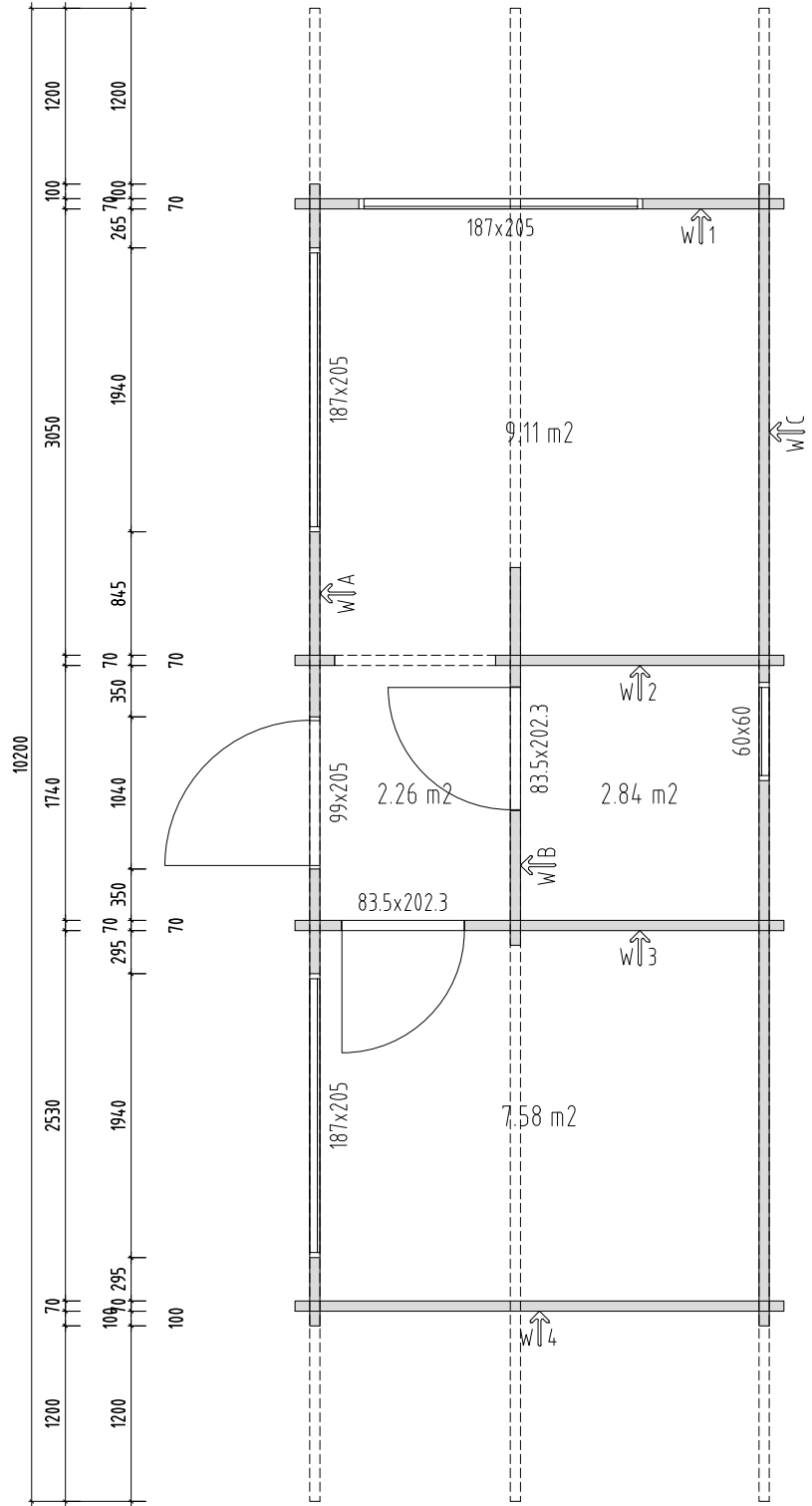
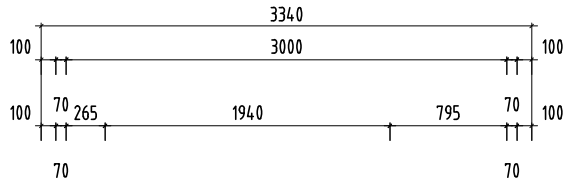

A

B

C

1

2





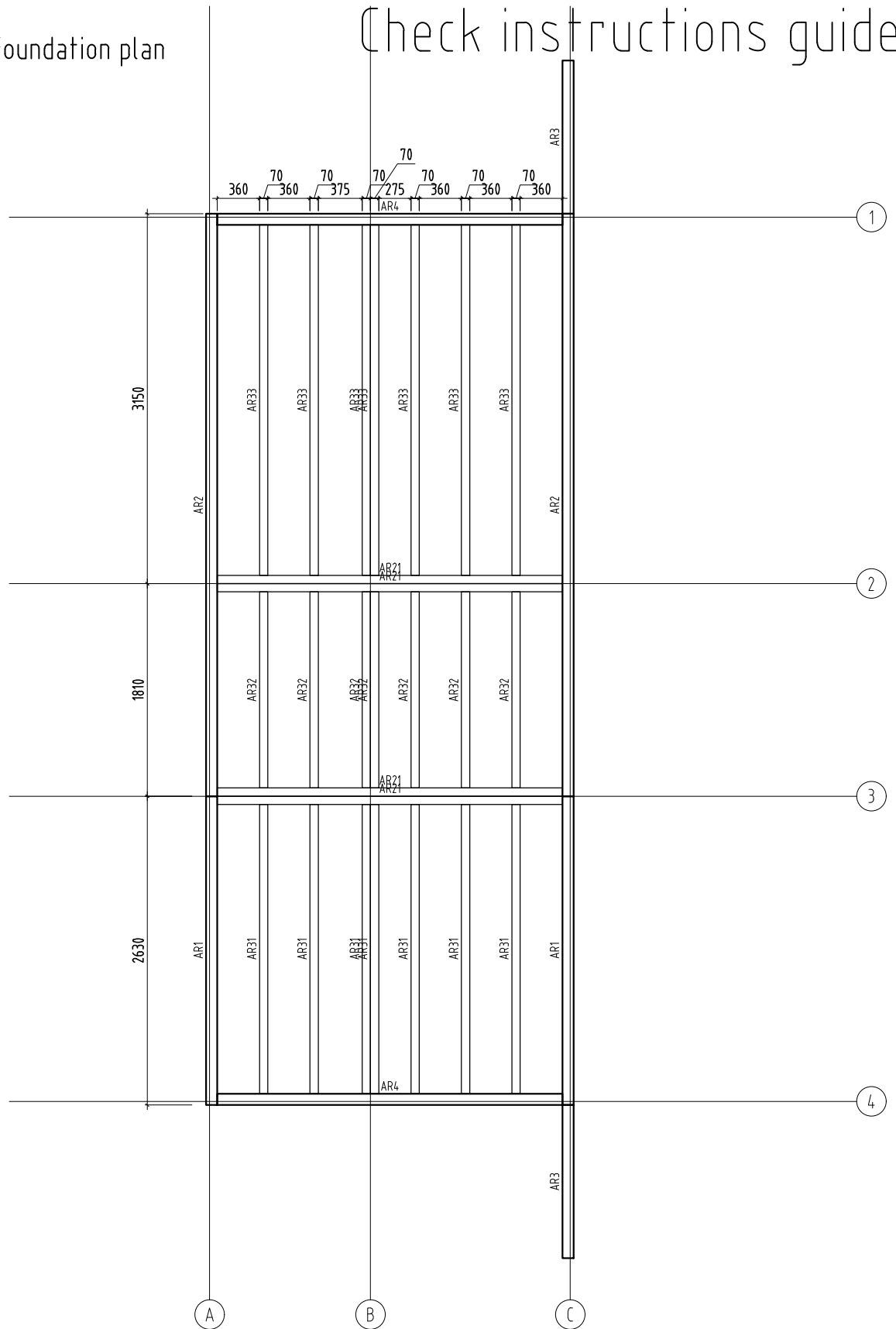

3

4

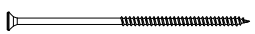
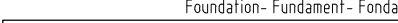
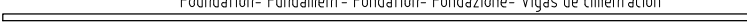
Plan 1 : Foundation plan

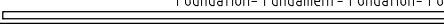
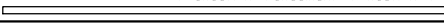
Check instructions guide

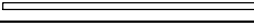

QKRPP 6x160 ZnTX-1	Screw- Schraube- Vis- Vite- Tornillo- 6x160mm TX-1		76	AR1, AR2,...
AR1	Foundation- Fundament- Fondation- Fondazione- Vigas de cimentación		2	95x45 2630
AR2	Foundation- Fundament- Fondation- Fondazione- Vigas de cimentación		2	95x45 4960
AR3	Foundation- Fundament- Fondation- Fondazione- Vigas de cimentación		2	95x45 1305
AR4	Foundation- Fundament- Fondation- Fondazione- Vigas de cimentación		2	95x45 2940
AR21	Foundation- Fundament- Fondation- Fondazione- Vigas de cimentación 2		4	70x45 2940
AR31	Foundation- Fundament- Fondation- Fondazione- Vigas de cimentación- NAT		7	70x45 2465
AR32	Foundation- Fundament- Fondation- Fondazione- Vigas de cimentación- NAT		7	70x45 1670
AR33	Foundation- Fundament- Fondation- Fondazione- Vigas de cimentación- NAT		7	70x45 2985

Plan 2 : Wall plan

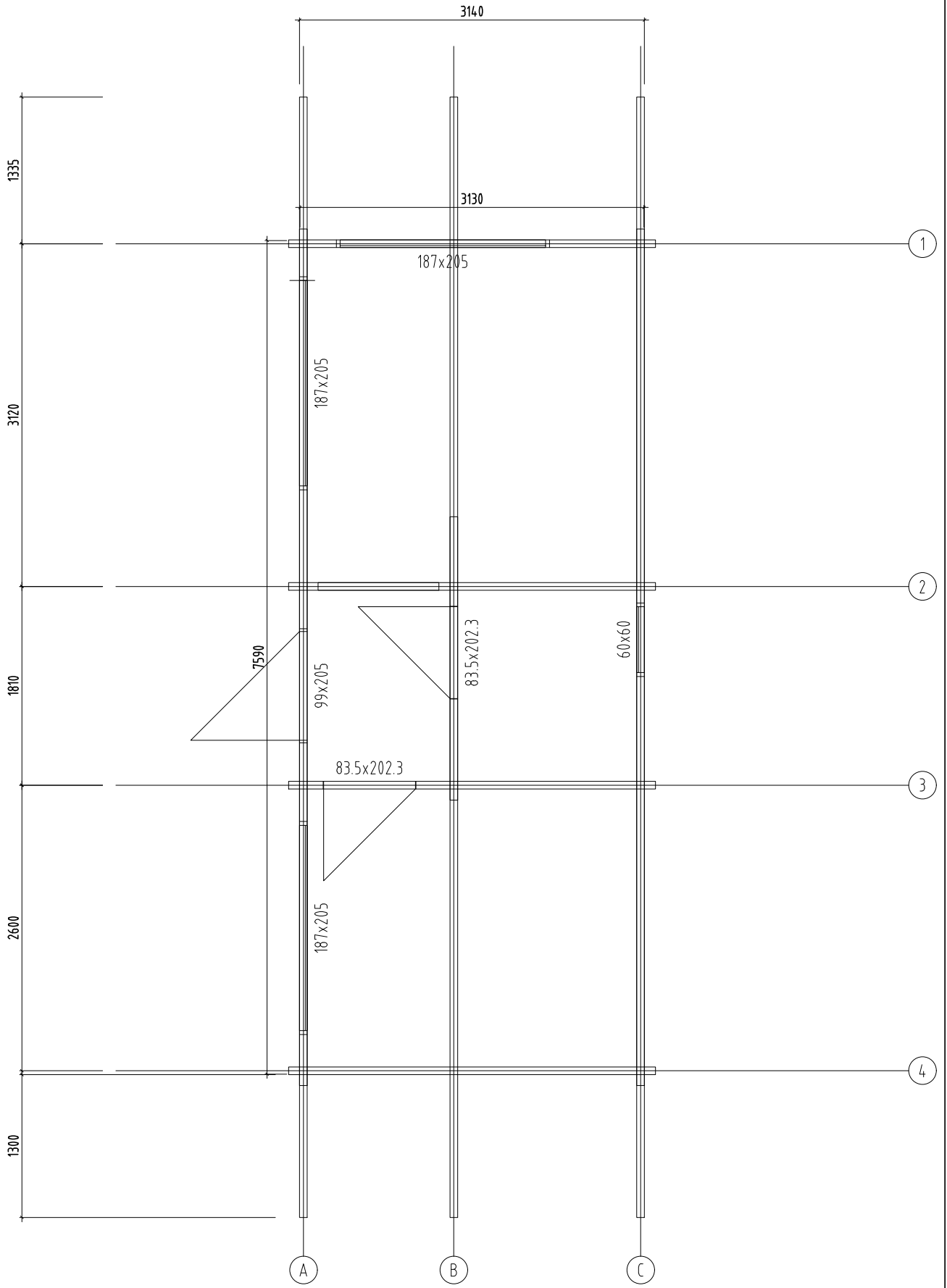

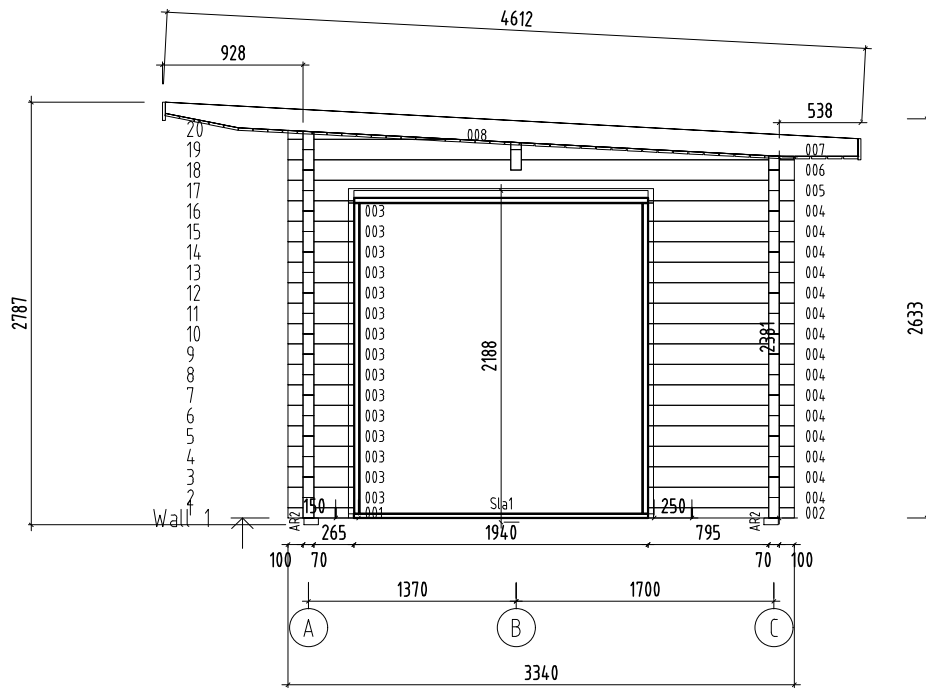

Plan 3 : WALL 1 plan



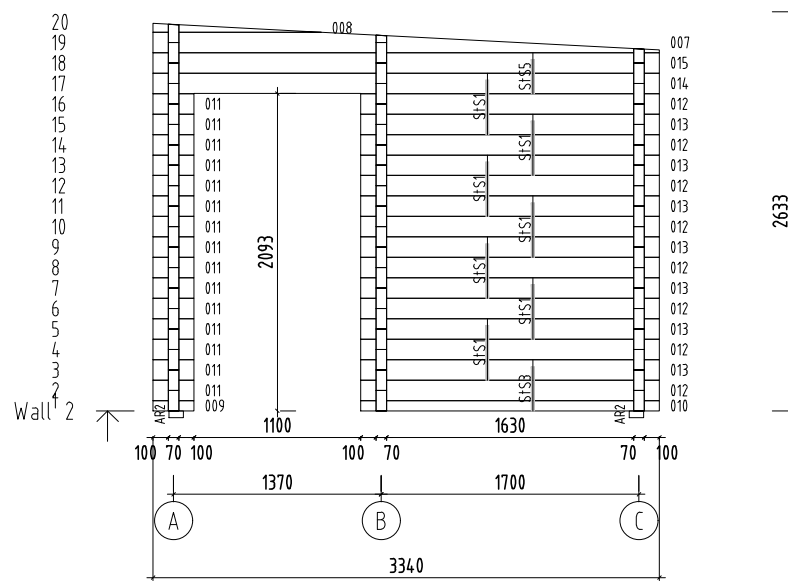



Plan 4 : WALL 2 plan

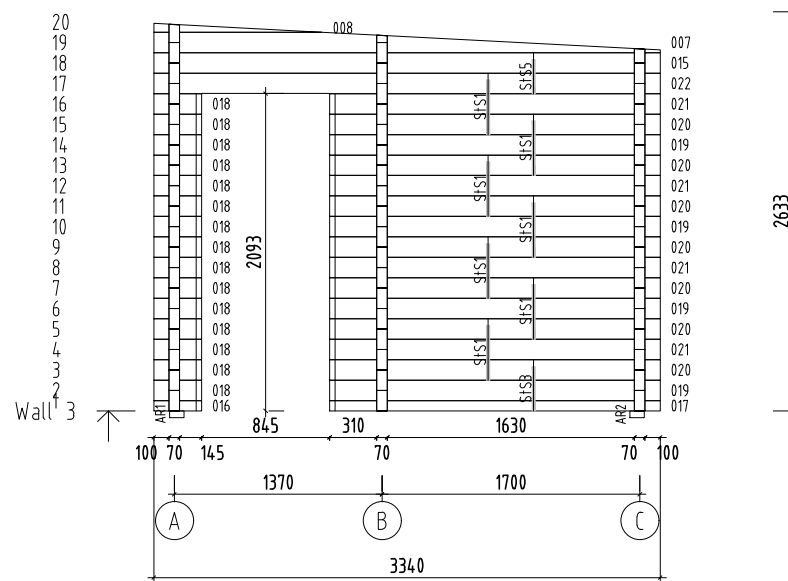

ST51	Stabilizing stick- Stabilisierungsstock- Baton équilibrant- Bastone stabilizzatore- Palo estabilizador		7	16x16	360
ST53	Stabilizing stick- Stabilisierungsstock- Baton équilibrant- Bastone stabilizzatore- Palo estabilizador		1	16x16	290
ST55	Stabilizing stick- Stabilisierungsstock- Baton équilibrant- Bastone stabilizzatore- Palo estabilizador		1	16x16	225



Plan 5 : WALL 3 plan

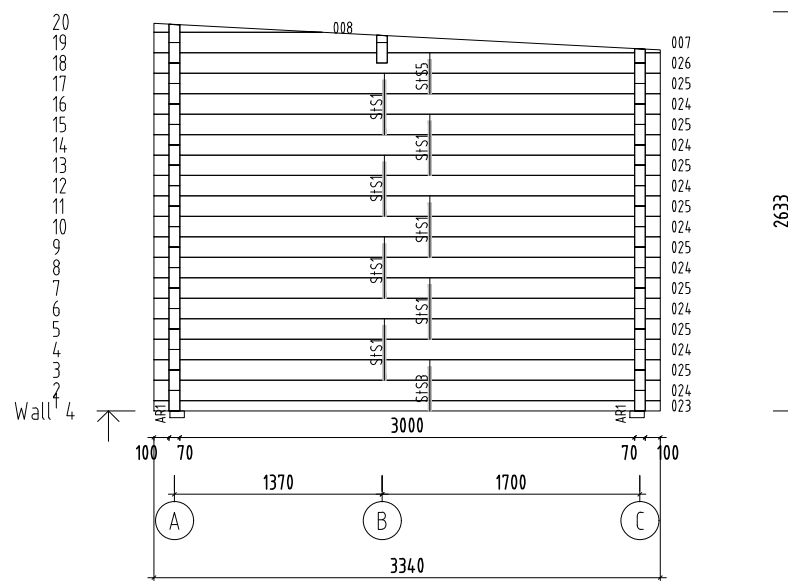

STs1	Stabilizing stick- Stabilisierungsstock- Baton équilibrant- Bastone stabilizzatore- Palo estabilizador		7	16x16	360
STs3	Stabilizing stick- Stabilisierungsstock- Baton équilibrant- Bastone stabilizzatore- Palo estabilizador		1	16x16	290
STs5	Stabilizing stick- Stabilisierungsstock- Baton équilibrant- Bastone stabilizzatore- Palo estabilizador		1	16x16	225

Plan 6 : WALL 4 plan



ST1	Stabilizing stick- Stabilisierungsstock- Baton équilibrant- Bastone stabilizzatore- Palo estabilizador		7	16x16	360
ST3	Stabilizing stick- Stabilisierungsstock- Baton équilibrant- Bastone stabilizzatore- Palo estabilizador		1	16x16	290
ST5	Stabilizing stick- Stabilisierungsstock- Baton équilibrant- Bastone stabilizzatore- Palo estabilizador		1	16x16	225

Plan 7 : WALL A plan

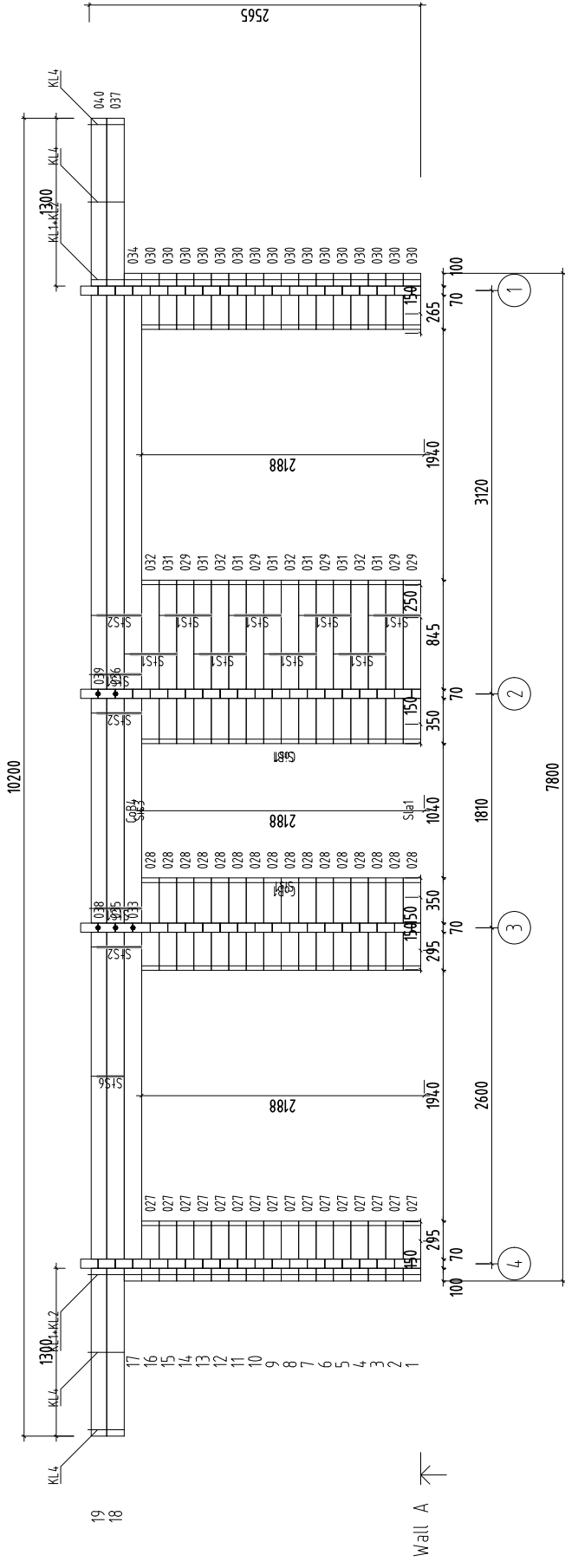

KL1	Threaded rod- Barre filettée- Asta filettata- Varilla roscada M10		2	2000
KL2	Threaded rod- Gewindestangen- Barre filettée- Asta filettata- Varilla roscada M10		2	600
KL4	Threaded rod- Gewindestangen- Barre filettée- Asta filettata- Varilla roscada M10		4	305
QMUK K10ZN	Nut- Schraubenmutter- Écrou- Dado- Tuerca- M10mm		6	
QSE10 X30ZN	Washer- Dichtscheibe- Joint- Rondella- Arandela- 10x30mm		6	
QMUJ 10ZN	Extension nut- Verlängerungsmutter- Ecrou rallonge- Dado di prolunga- Tuerca de extension- JM10		2	
QMUP L10ZN	Top nut- Schweissmutter mit Flansch- Ecrou a souder- Dado a saldare- Tuerca soldable- M10		6	
StS1	Stabilizing stick- Stabilisierungsstock- Baton équilibrant- Bastone stabilizzatore- Palo estabilizador		73	16x16 360
StS2	Stabilizing stick- Stabilisierungsstock- Baton équilibrant- Bastone stabilizzatore- Palo estabilizador		3	16x16 345
StS6	Stabilizing stick- Stabilisierungsstock- Baton équilibrant- Bastone stabilizzatore- Palo estabilizador		1	16x16 210

Plan 8 : WALL B plan

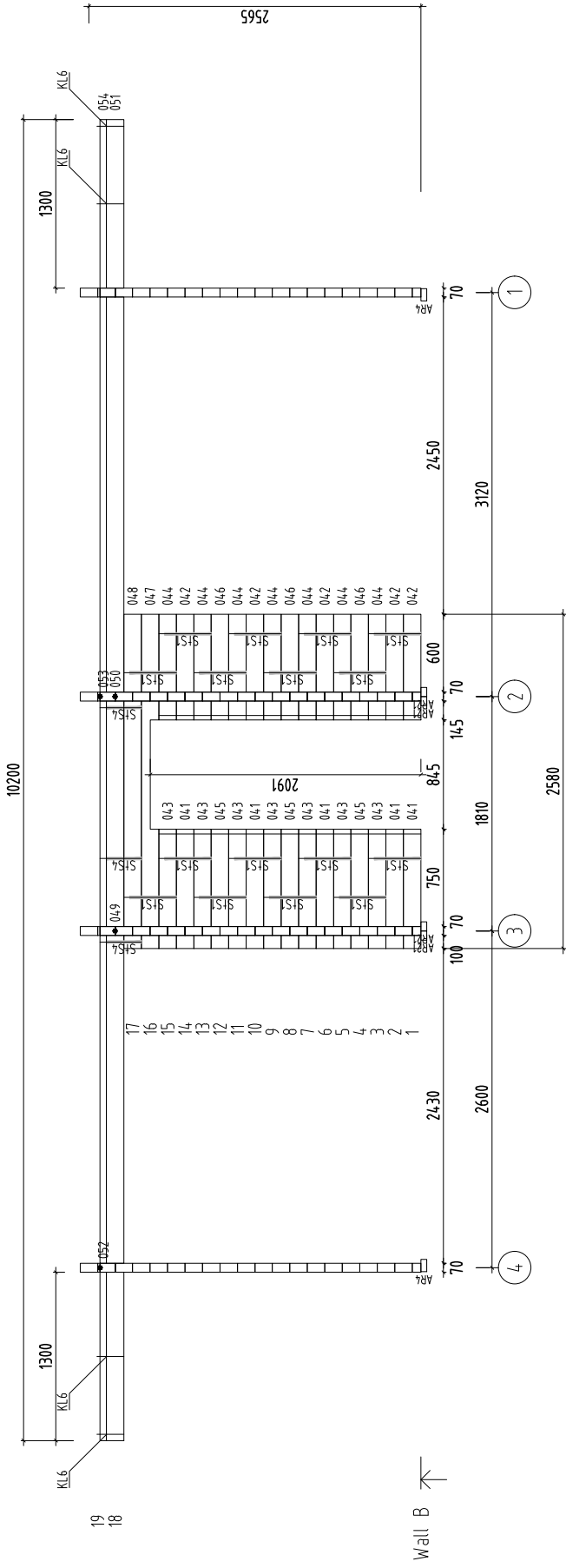

KL6	Threaded rod- Gewindestangen- Barre filettée- Asta filettata- Varilla roscada M10		4	234
QMUK K10ZN	Nut- Schraubenmutter- Écrou- Dado- Tuerca- M10mm		4	
QSE10 X30ZN	Washer- Dichtscheibe- Joint- Rondella- Arandela- 10x30mm		4	
SFS1	Stabilizing stick- Stabilisierungsstock- Baton équilibrant- Bastone stabilizzatore- Palo estabilizador		16	16x16 360
SFS4	Stabilizing stick- Stabilisierungsstock- Baton équilibrant- Bastone stabilizzatore- Palo estabilizador		3	16x16 270



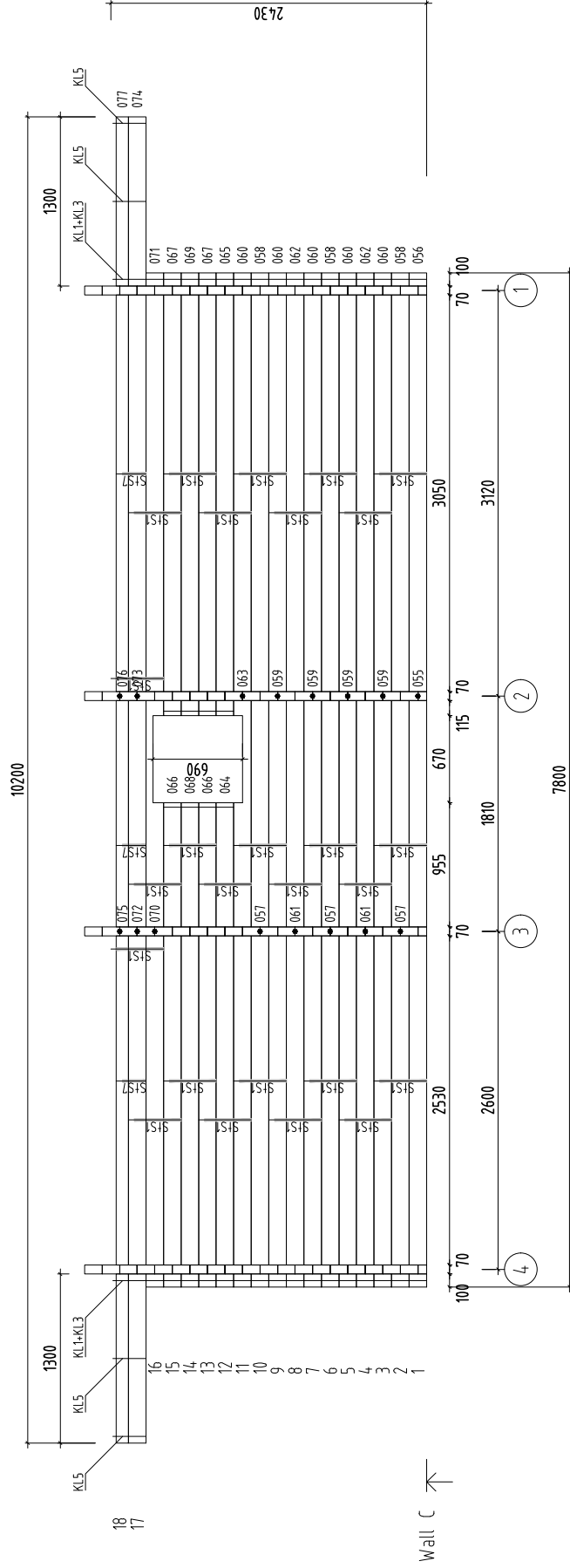

Plan 8-1 : WALL C plan

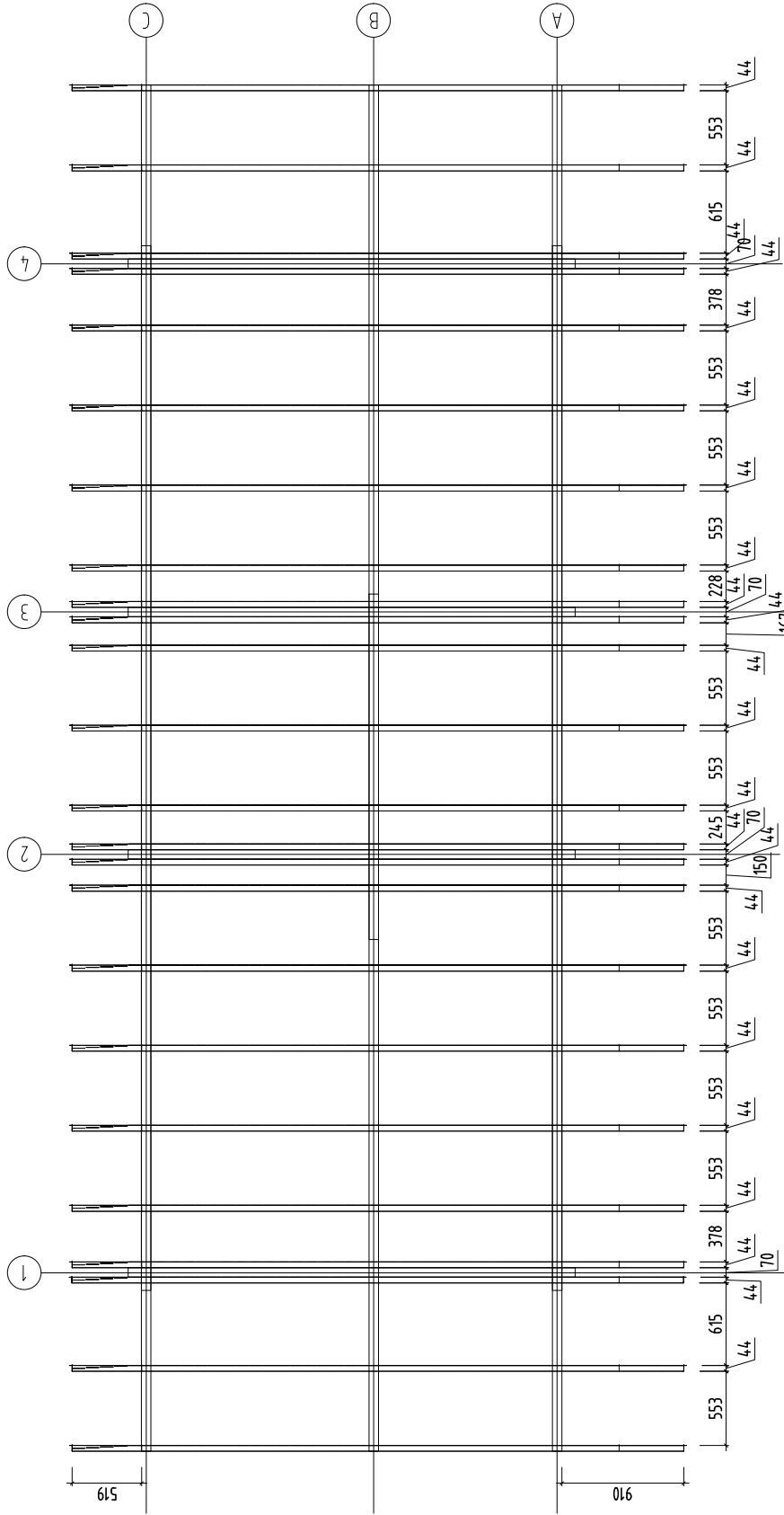
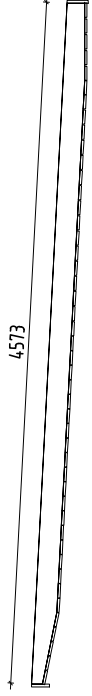

KL1	Threaded rod- Gewindestangen- Barre filettée- Asta filettata- Varilla roscada M10		2	2000
KL3	Threaded rod- Gewindestangen- Barre filettée- Asta filettata- Varilla roscada M10		2	440
KL5	Threaded rod- Gewindestangen- Barre filettée- Asta filettata- Varilla roscada M10		4	280
QMUK K10ZN	Nut- Schraubenmutter- Écrou- Dado- Tuerca- M10mm		6	
QSE10 X30ZN	Washer- Dichtscheibe- Joint- Rondella- Arandela- 10x30mm		6	
QMUJ 10ZN	Extension nut- Verlängerungsmutter- Écrou rallonge- Dado di prolunga- Tuerca de extensión- JM10		2	
QMUP L10ZN	Top nut- Schweissmutter mit Flansch- Ecrou a souder- Dado a saldare- Tuerca soldable- M10		6	
STS1	Stabilizing stick- Stabilisierungsstock- Baton équilibrant- Bastone stabilizzatore- Palo estabilizador		24	16x16 360
STS7	Stabilizing stick- Stabilisierungsstock- Baton équilibrant- Bastone stabilizzatore- Palo estabilizador		3	16x16 180



Plan 9 : Rafter plan



QKRYP8 x260Zn	Screw - Schraube - Vis - Vite - Tornillo - 8x260mm ZnY -		50
QKRPP4 5x70Zn	Screw - Schraube - Vis - Vite - Tornillo - 4.5x70mm		138
RoR1	Rafter - Sparré - Chevron - Trave - Cabrio		24 140x44 4573
RoR2	Rafter - Sparré - Chevron - Trave - Cabrio		6 140x44 5100

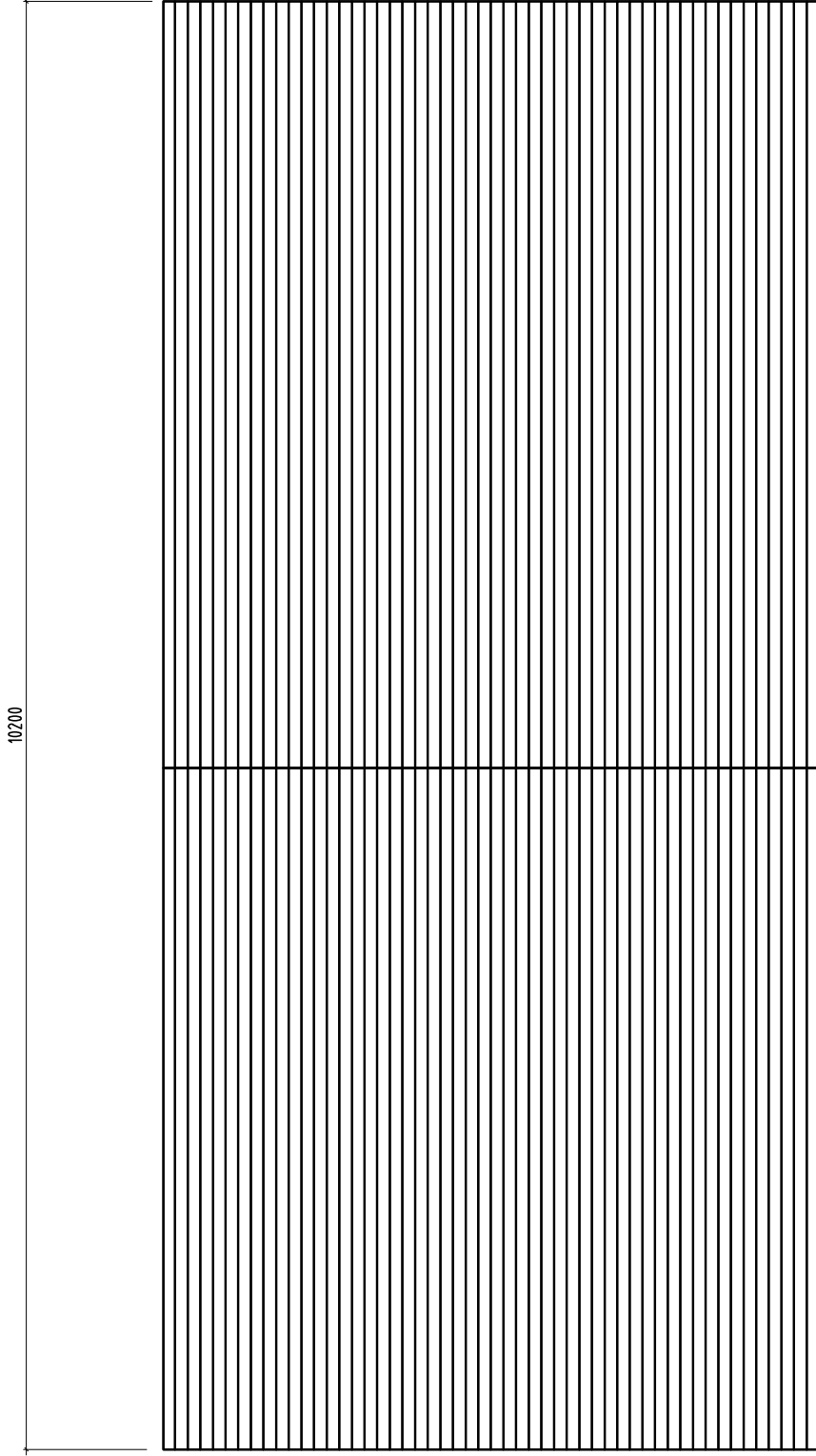





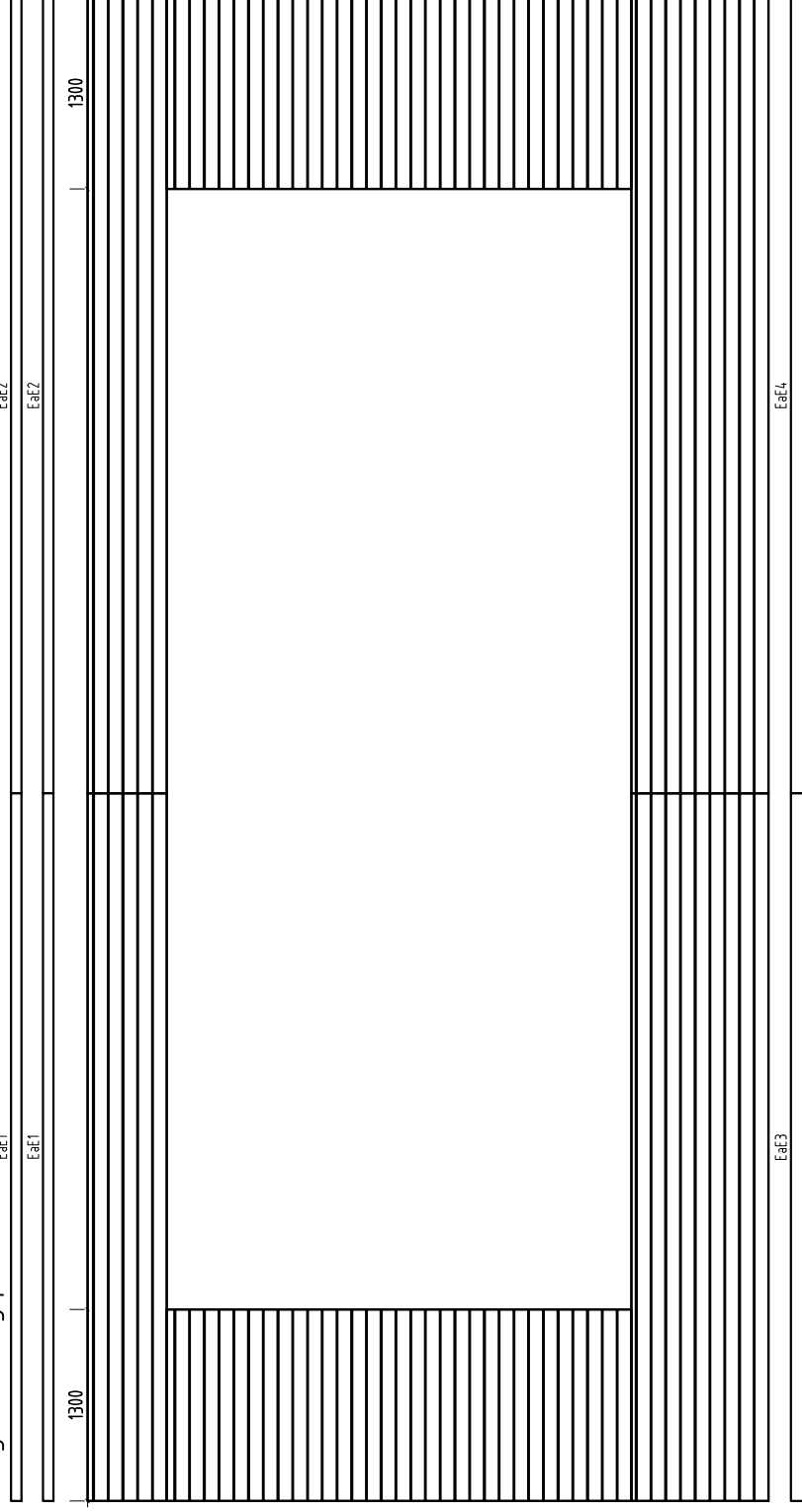

Plan 10 : Roof boarding plan



QNA2 2x50Zn	Nail - Nagel - Clou - Chiodo - Clavo - 2.5x50mm		1300	RB2-1 RB2-2
RB2-1	Roof board - Dachbrett - Madrier du toit - Tavola tetto - Tabla de tejado		52+1	89x19
RB2-2	Roof board - Dachbrett - Madrier du toit - Tavola tetto - Tabla de tejado		52+1	89x19
				5400
				4800



Plan 11 : Terrace ceiling boarding plan

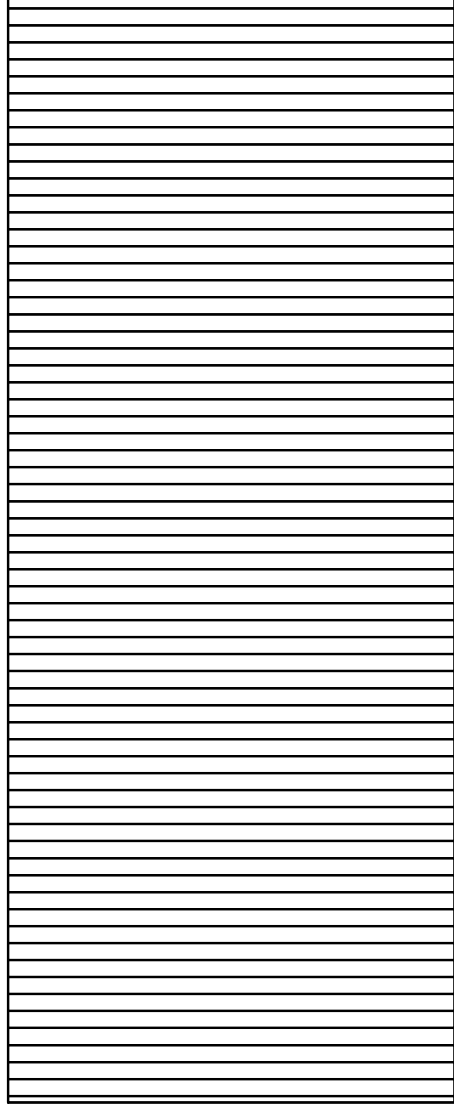

QKRPP3 5x50Zn	Screw - Schraube - Vis - Vite - Tornillo - 3.5x50mm		560
TB3-1	Ceiling board- Dachbodenbrett- Madrier du Grenier- Tavola soffitta- Tabla de techo		16+2 95x16 5400
TB3-2	Ceiling board- Dachbodenbrett- Madrier du Grenier- Tavola soffitta- Tabla de techo		16+2 95x16 4800
TB3-3	Ceiling board- Dachbodenbrett- Madrier du Grenier- Tavola soffitta- Tabla de techo		64+2 95x16 1300
EaE1	Eave edging- Dachrandbrett- Madrier en bordure du toit- Tavola bordo tetto- Tabla de valadizo		2 70x28 4800
EaE2	Eave edging- Dachrandbrett- Madrier en bordure du toit- Tavola bordo tetto- Tabla de valadizo		2 70x28 5400
EaE3	Eave edging- Dachrandbrett- Madrier en bordure du toit- Tavola bordo tetto- Tabla de valadizo		1 120x28 4800
EaE4	Eave edging- Dachrandbrett- Madrier en bordure du toit- Tavola bordo tetto- Tabla de valadizo		1 120x28 5400

Plan 12 : Floor board plan



QVA3 x70Zn	Nail- Nagel- Clou- Chiodo- Clavo- 3x70mm		700	2FB3-1	
FIB3-1	Floor beading- Fussbodenleiste- Baguette du plancher- Listello pavimento- Listón de suelo		10	19x45	2360
2FB3-1	Floor board- Fussbodenbrett- Madrier du plancher - Tavola pavimento- Tabla de suelo		66+1	114x28	2994

Plan 13 : Window - Fenster - Fenetre - Finestra-Ventana 600x600



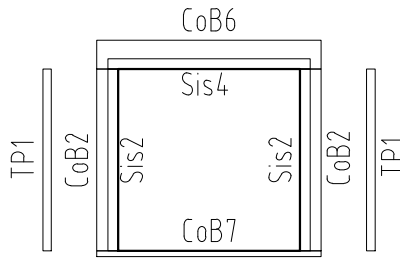



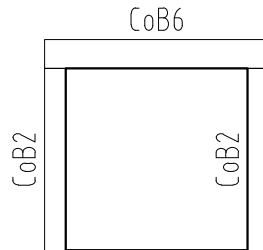







COB INTERNAL

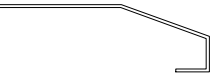

COB EXTERNAL

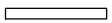

Check instructions guide !

QLY-A CVG45Z	Window fittings- Fenstergriff- Poigne de la fenêtre- Maniglia finestra- Manilla- QLY-ACVG45Z		1		
QLY-A CMAS29	Window fittings- Fenstergriff- Poigne de la fenêtre- Maniglia finestra- Manilla- QLY-ACMAS29		1		
QLY-A CMAS33	Window fittings- Fenstergriff- Poigne de la fenêtre- Maniglia finestra- Manilla- QLY-ACMAS33		1		
QKRPP3 _5x50Zn	Screw- Schraube- Vis- Vite- Tornillo- 3.5x50mm		22		
QKRYP 5x60Zn	Screw- Schraube- Vis- Vite- Tornillo- 5x60mm ZnY		4	U51-5 A51-13	
A51-13 P-7016	Window - Fenster - Fenetre - Finestra-Ventana 600x600	  500x500mm	1		
QP40x3 0x740MU	Water gutter- Wasserleiste- Rejet d'eau- Protección de lluvia- Protezione dalla pioggia- QP40x30x740		1	A51-13	
QTI40-1	Seal- Dichtung- Joint d'isolation- Guarnizione- Burlete- QTI40		3		
TP1	Tender post- Tenderleiste- T-poste- Rinforzo- Refuerzo		2	28x28	600
Sis2	Side slat- Randleiste- Baguette en bordure- Listón de borde- Listello bordo		2	34x70	600
Sis4	Side slat- Randleiste- Baguette en bordure- Listón de borde- Listello bordo		1	34x70	668
CoB2	Covering board- Deckbrett- Madrier de couverture- Tavola di copertura- Listón de cubierta		4	70x16	600
CoB7	Covering board- Deckbrett- Madrier de couverture- Tavola di copertura- Listón de cubierta		1	19x95	740
CoB6	Covering board- Deckbrett- Madrier de couverture- Tavola di copertura- Listón de cubierta		2	95x16	740

Plan 14 : Door - Tür - Porte - Porta-Puerta 990x2050

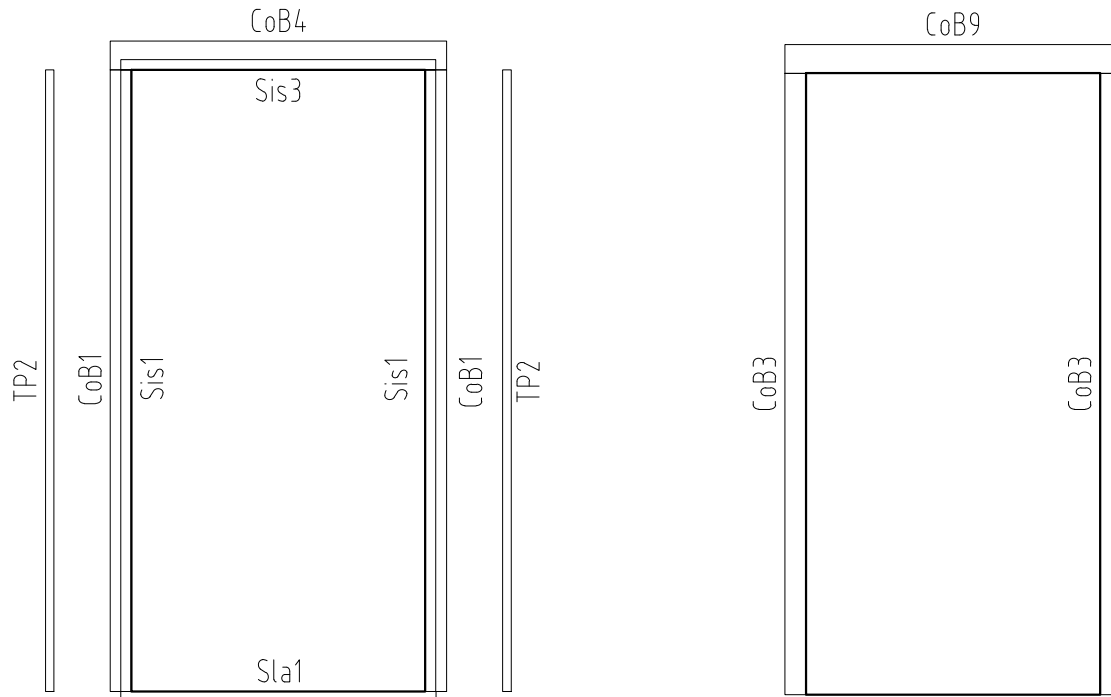

COB INTERNAL

COB EXTERNAL

Check instructions guide !

QTI40-1 Seal- Dichtung- Joint d'isolation- Guarnizione- Burtete- QTI40



QP40x30 x1109MU Water gutter- Wasserleiste- Rejet d'eau- Protección de lluvia- Protezione dalla pioggia- QP40x30x1109



1 U51-5

QLY-LWB02 Cylinder- Zylinderschloss- Serrure a mortaiser- Serratura a cilindro- Bombin- QLY-LWB02

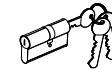

1

QLY-A CWKS92 Door fittings- Türbeschlag- Ferrure- Ferramenta porta- Manilla (puerta)- QLY-ACWKS92



1

QKRPP3 5x50Zn Screw- Schraube- Vis- Vite- Tornillo- 3.5x50mm



28

QKRYP 5x60Zn Screw- Schraube- Vis- Vite- Tornillo- 5x60mm ZnY



8

U51-5
A51-13

Tender post- Tenderleiste- T-poste- Rinforzo- Refuerzo

TP2

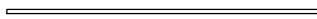

2

28x28

2050

Covering board- Deckbrett- Madrier de couverture- Tavola di copertura- Listón de cubierta

CoB3



2

70x16

2049

Covering board- Deckbrett- Madrier de couverture- Tavola di copertura- Listón de cubierta

CoB1



2

70x28

2050

Covering board- Deckbrett- Madrier de couverture- Tavola di copertura- Listón de cubierta

CoB4



1

95x28

1109

Covering board- Deckbrett- Madrier de couverture- Tavola di copertura- Listón de cubierta

CoB9



1

95x16

1110

Side slat- Randleiste- Baguette en bordure- Listón de borde- Listello bordo

Sis1



2

34x70

2050

Side slat- Randleiste- Baguette en bordure- Listón de borde- Listello bordo

Sis3



2

34x70

1038

Slat- Leiste- Baguette- Listello- Listón

Sla1



1

28x70

1039

Plan 15 : MLU59-5P-7016 x 3

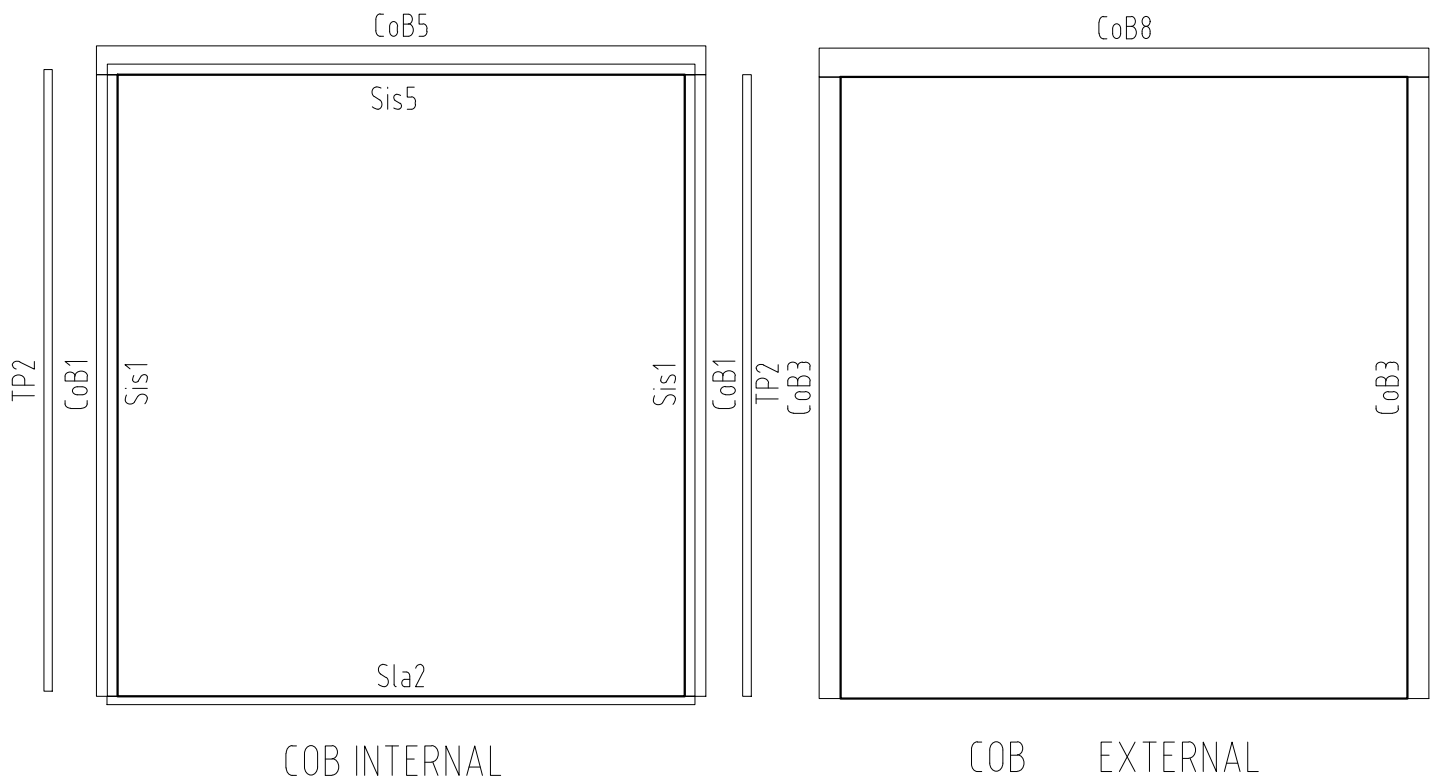

Check instructions guide !

QP40x30 x2010MU Water gutter- Wasserleiste- Rejet d'eau- Protección de lluvia- Protezione dalla pioggia- QP40x30x2010

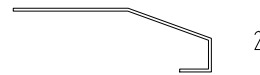

2

QTI40-1 Seal- Dichtung- Joint d'isolation- Guarnizione- Burlete- QTI40



QKRPP3 5x50Zn Screw- Schraube- Vis- Vite- Tornillo- 3.5x50mm



56

QKRYP 5x60Zn Screw- Schraube- Vis- Vite- Tornillo- 5x60mm ZnY

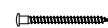

20

U51-5
A51-13

Tender post- Tenderleiste- T-poste- Rinforzo- Refuerzo

TP2



4

28x28

2050

Covering board- Deckbrett- Madrier de couverture- Tavola di copertura- Listón de cubierta

CoB3



4

70x16

2049

Covering board- Deckbrett- Madrier de couverture- Tavola di copertura- Listón de cubierta

CoB1



4

70x28

2050

Covering board- Deckbrett- Madrier de couverture- Tavola di copertura- Listón de cubierta

CoB5



2

95x28

2010

Covering board- Deckbrett- Madrier de couverture- Tavola di copertura- Listón de cubierta

CoB8



2

95x16

2010

Side slat- Randleiste- Baguette en bordure- Listón de borde- Listello bordo

Sis1



4

34x70

2050

Slat- Leiste- Baguette- Listello- Listón



Sla2



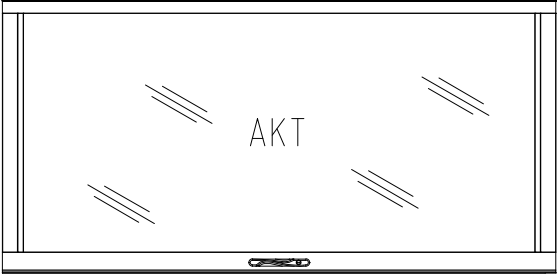
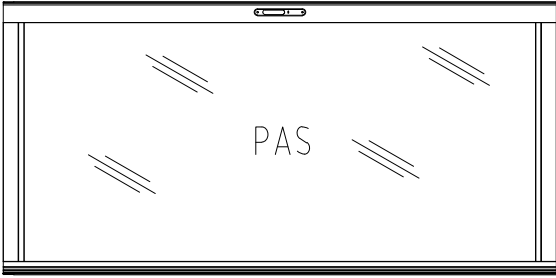
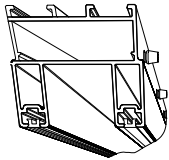
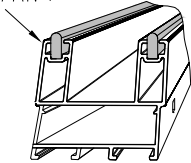
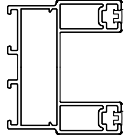

2

28x70

1939

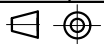
Pos	Plan 15 : MLU59-5P-7016	Pcs	Profile (mm)	Length (mm)
A-2		3	916x42	1968
B-2		3	916x42	1968
SL8110 S-1		3	59x50	1870
SL8110 S-2	<p data-bbox="571 1238 735 1267">QLY - VG53/AN 1</p> 	3	59x50	1870
SL8110 S-3		3	59x50	2050
QLY-SL076S-1		3		1870

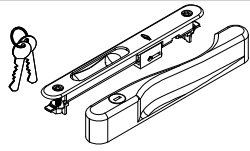
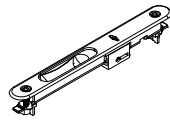
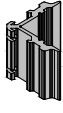
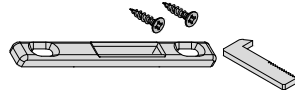
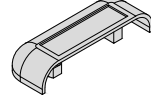
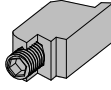
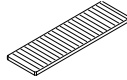
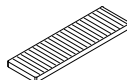

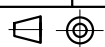
Pos	Plan 15 : MLU59-5P-7016		Pcs	Profile (mm)	Length (mm)
QLY-ACSL243			3		
QLY-ACSL240			3		
QLY-ACSL813A			12		
QLY-ACSL246			6		
QLY-ACSL024Z			6		
QLY-ALI170			48		
QPL20x100x2PET			24		
QPL20x100x3PET			24		
QSE3x8_5	Seal- Dichtung- Joint d'isolation- Guarnizione- Burlete		9		
QG-2	Hole plug- Abdeckkappe- Cache-vis- Tappi in legno- Embellecedor		9		
	Object name PM70-5233			Page	9/9

Plan 16 : Door - Tür - Porte - Porta-Puerta 835x2023

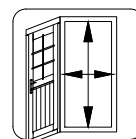
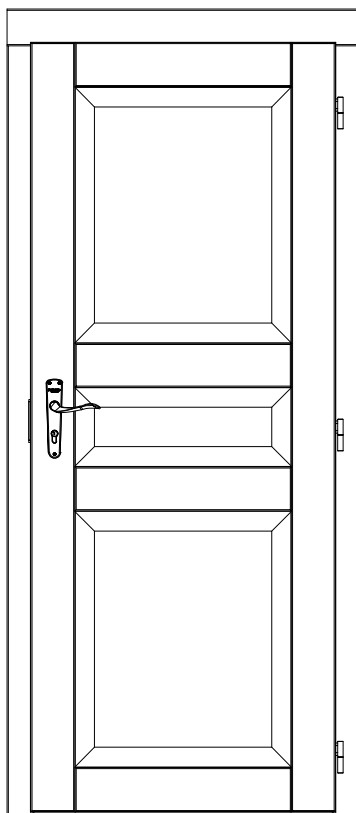

735x1954mm

Check instructions guide !

QVKA Door fittings- Türbeschlag- Ferrure- Ferramenta porta- Manilla (puerta)- QVKA



1

QLIUY-1 Door fittings- Türbeschlag- Ferrure- Ferramenta porta- Manilla (puerta)- QLIUY-1





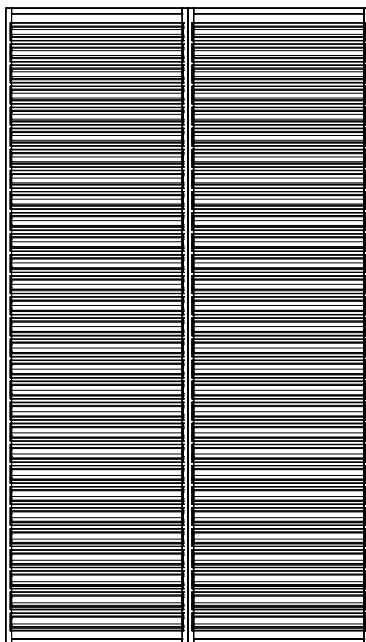

1

Plan 17 : žalusii- Louver- das Lattenfenster- la persienne- la persiana 600 x 2100 mm

žalusii- Louver- das Lattenfenster- la persienne- la persiana 600 x 2100 mm

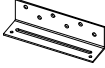

Check instructions guide !

QKRPP3 5x50Zn	Screw- Schraube- Vis- Vite- Tornillo- 3.5x50mm		14
QNU35x3 5x130Zn	L-iron- Winkel- Angle -Angolo- Angulo 35x35x130 EM VN353590		6
QNU50x6 5x130Zn	L-iron- Winkel- Angle -Angolo- Angulo- QNU50x65x130Zn		2
QKRKK 8x30Zn	Bolt -Schloss-schraube -Boulon- Bullone- Perno- 8x30mm KSKR		8
QKRYP5 x40ZnTX	Screw- Schraube- Vis- Vite- Tornillo- 5x40mm		22

žalusii- Louver- das Lattenfenster- la persienne- la persiana 600 x 2100 mm

4

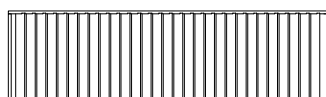

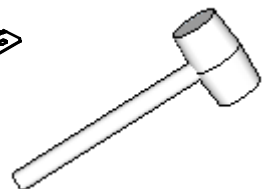
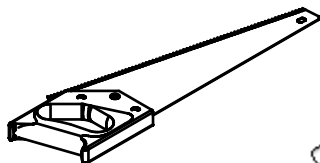
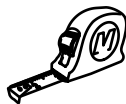
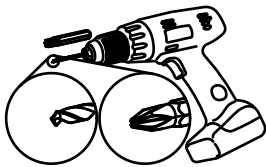
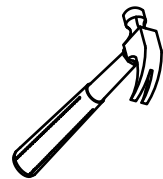
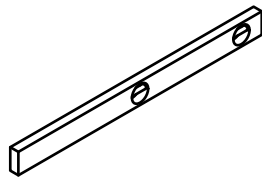
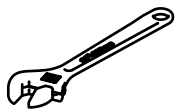
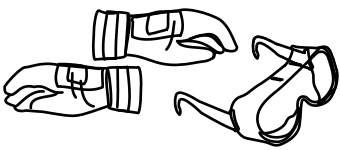
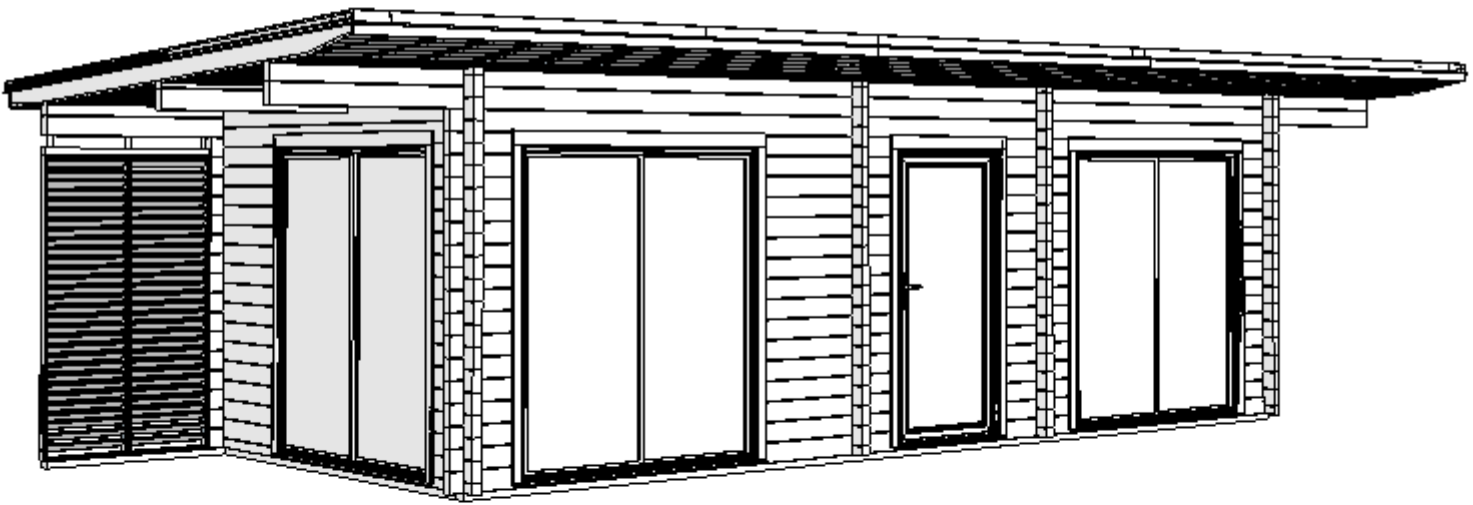

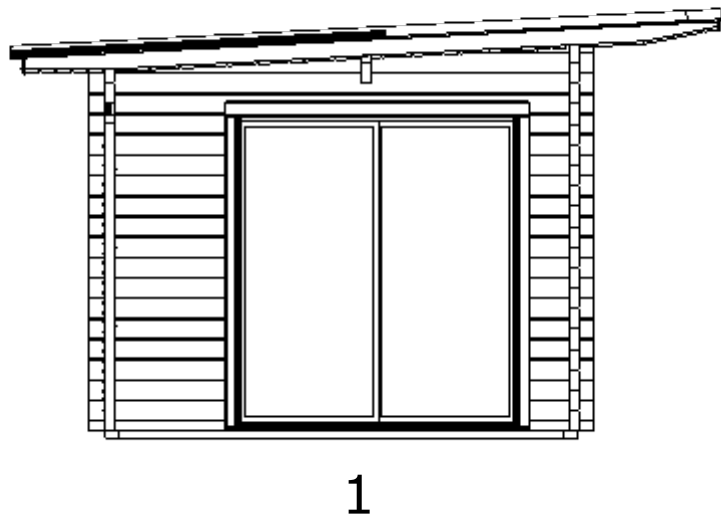
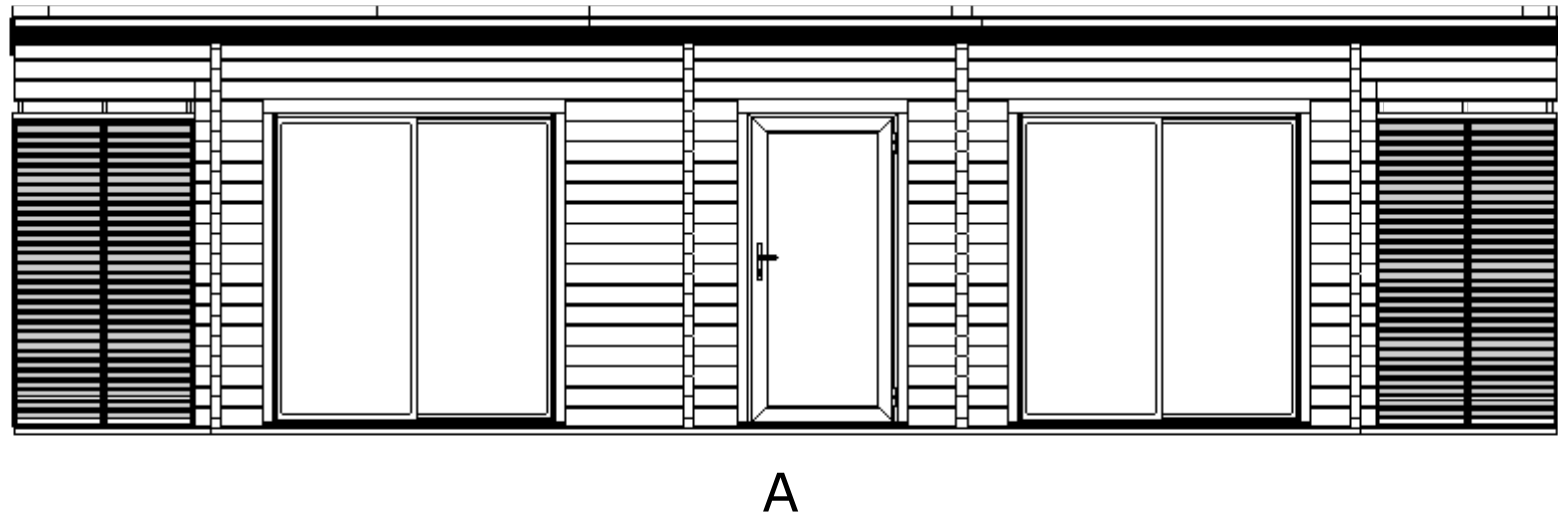
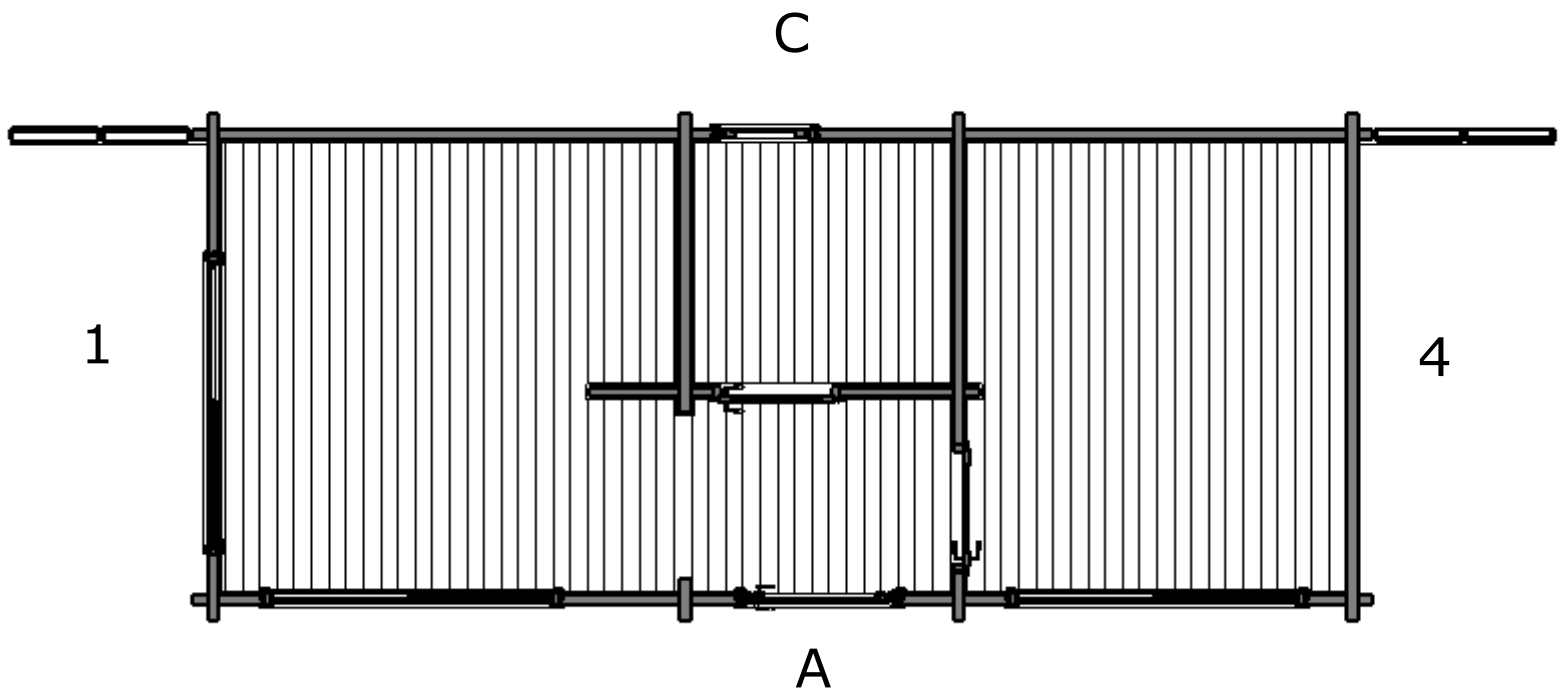

C

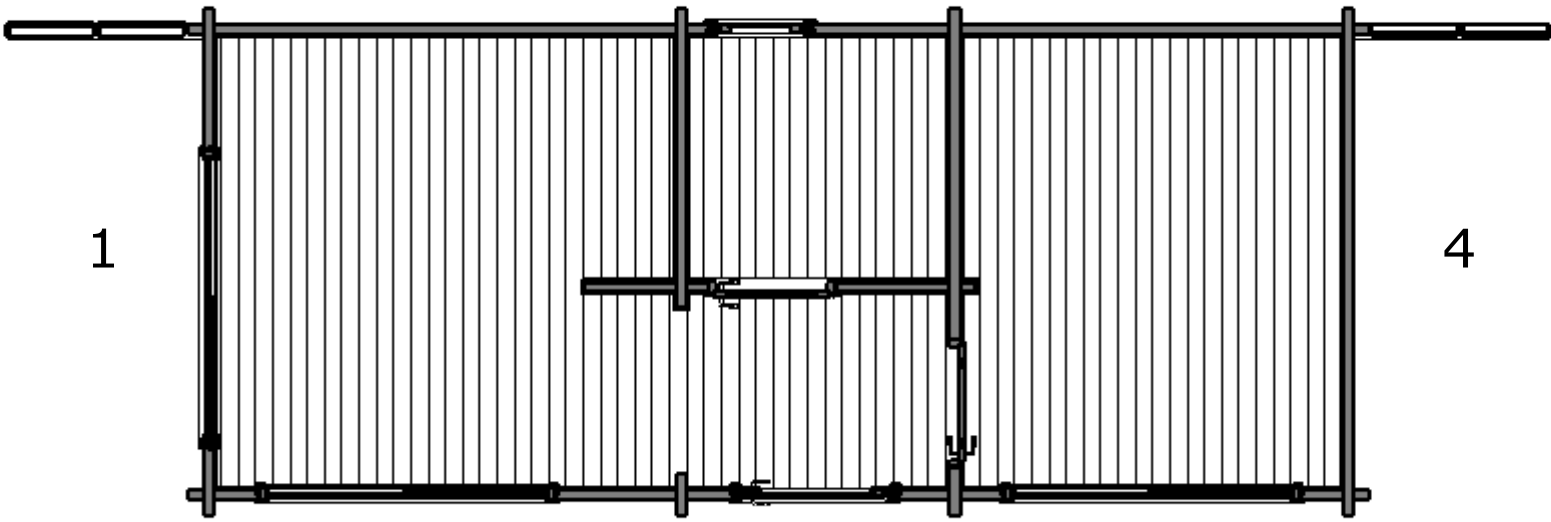

1

4

A

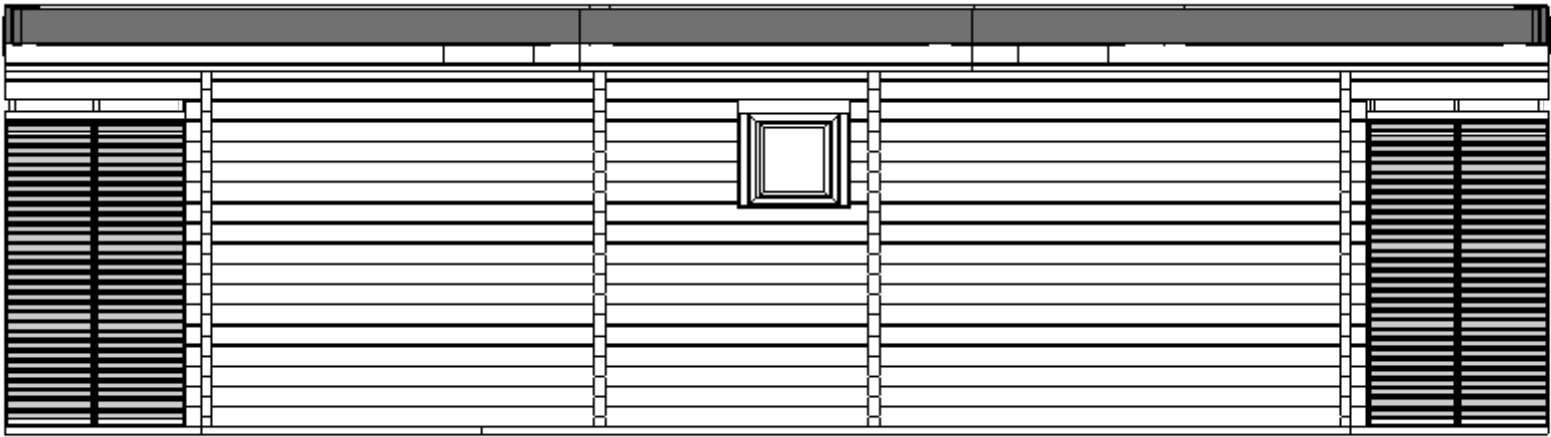

C

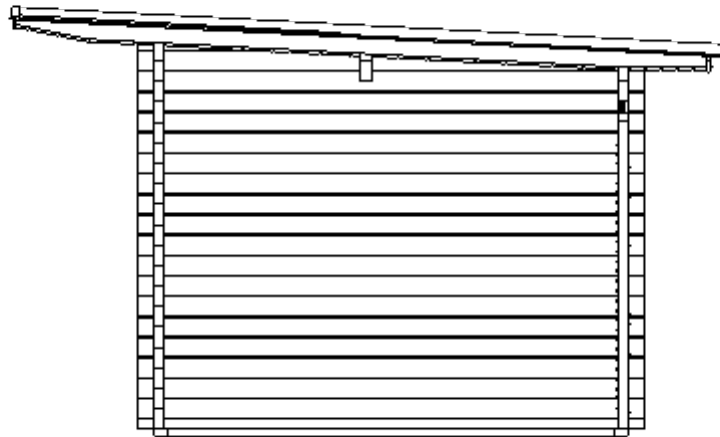

4

Plan: 1 Foundation
Positions: AR1, AR2,

 QKRPP6x160ZnTX-1

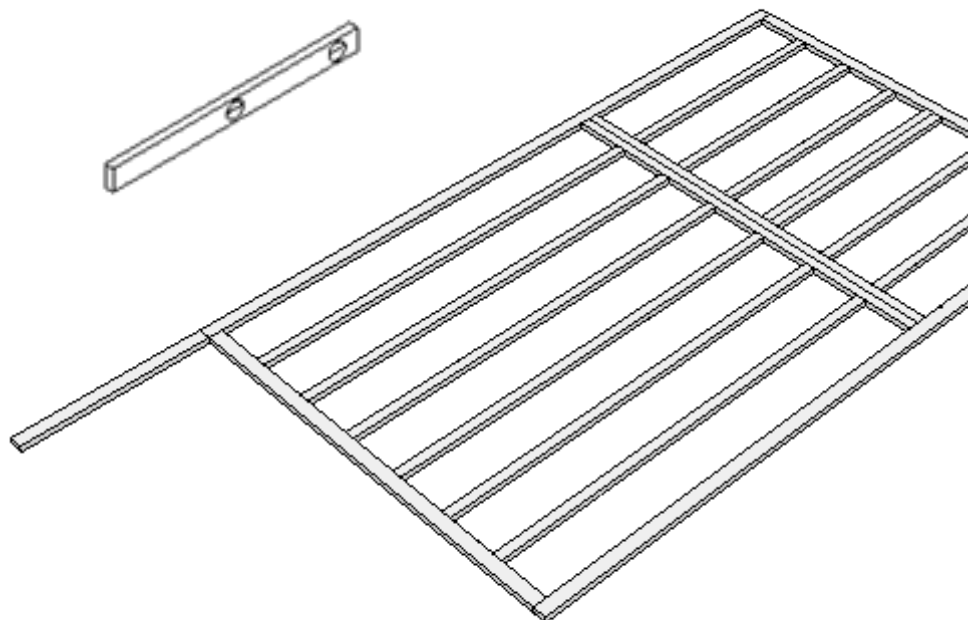

NOT INCLUDED

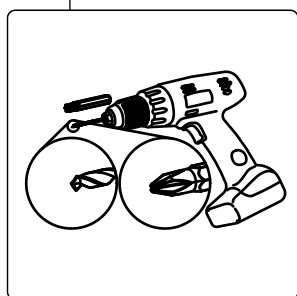
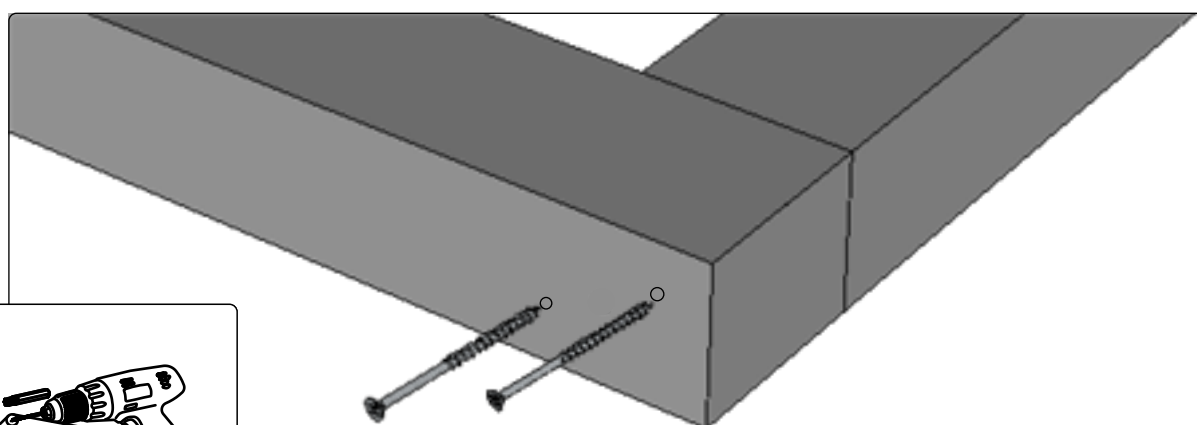
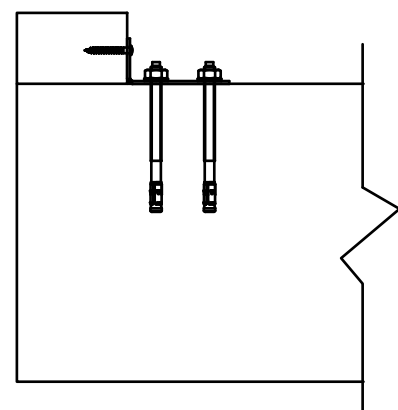
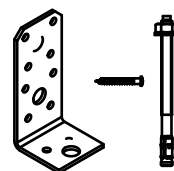

1

Plan: 1 Foundation + walls
Positions: AR1, AR2, ...+ LOGS

 QKRYP5X40ZnTX

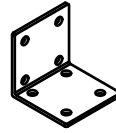

QNU20X20X40

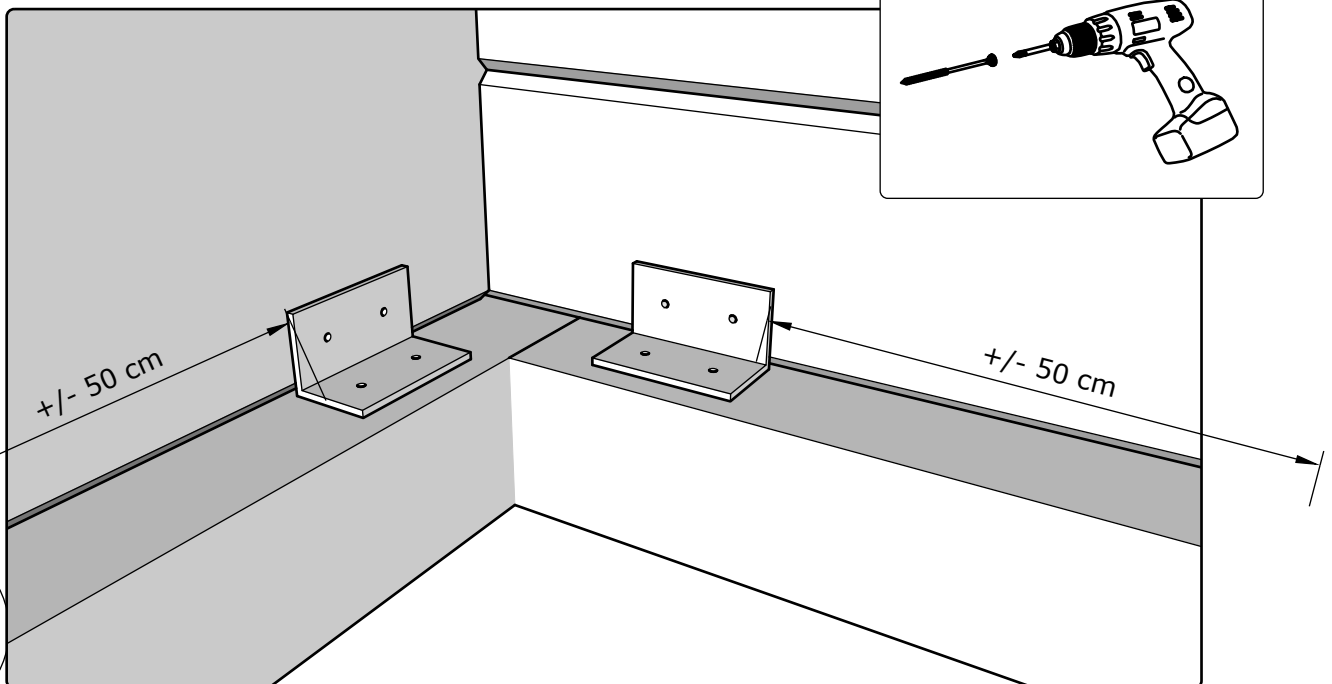
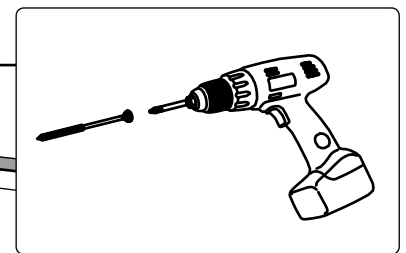
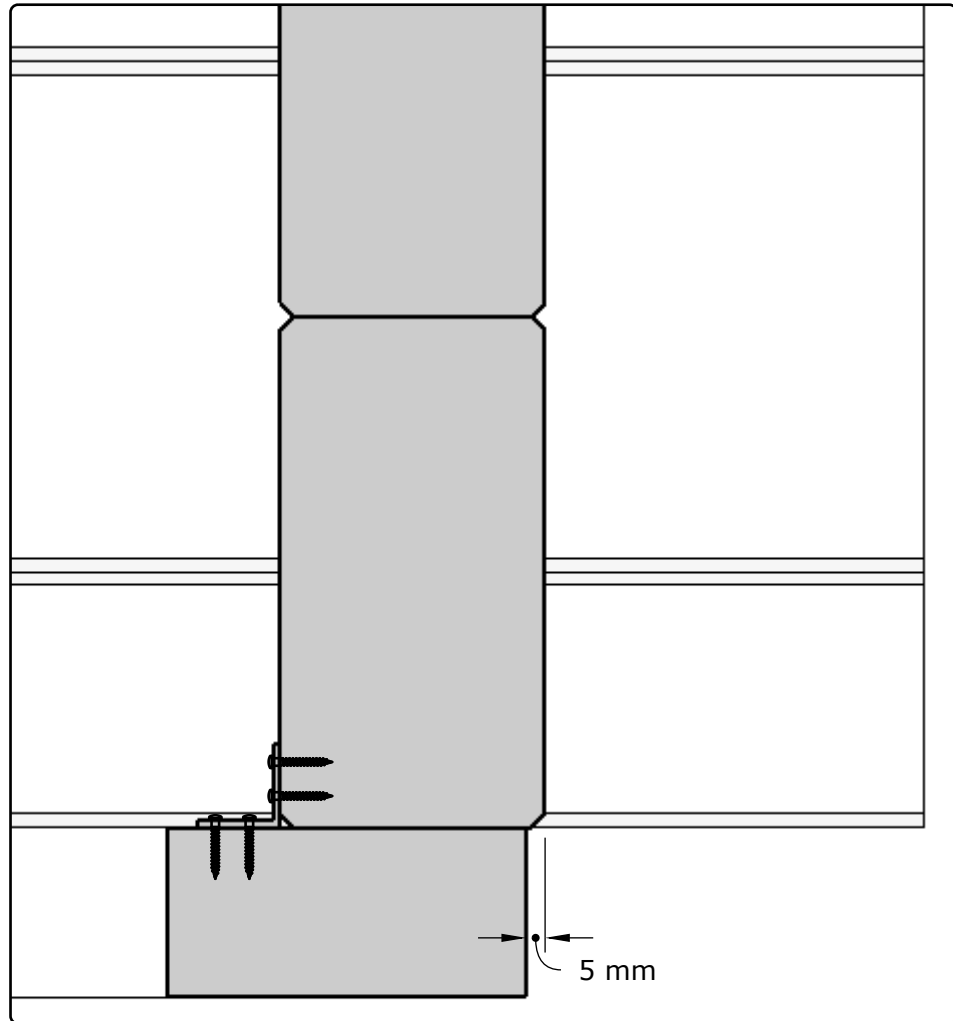
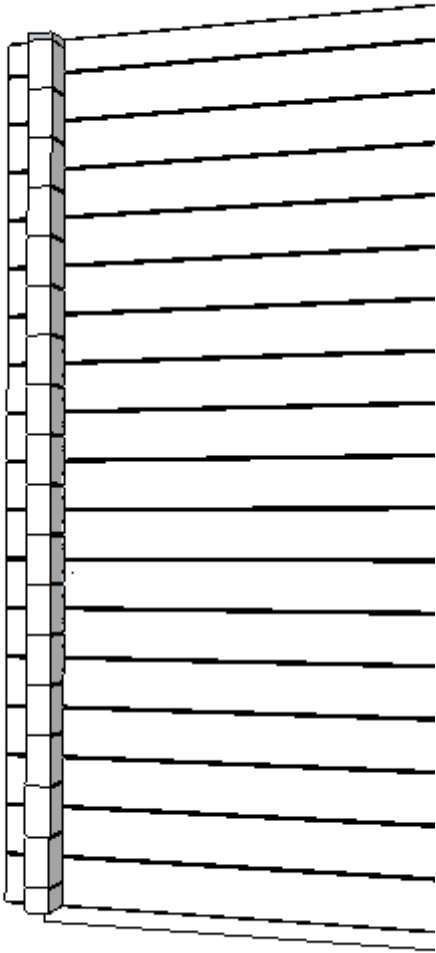

2

Plan: 2...8 Log wall assembly
 Positions: 001,002,...045,..

EXAMPLE

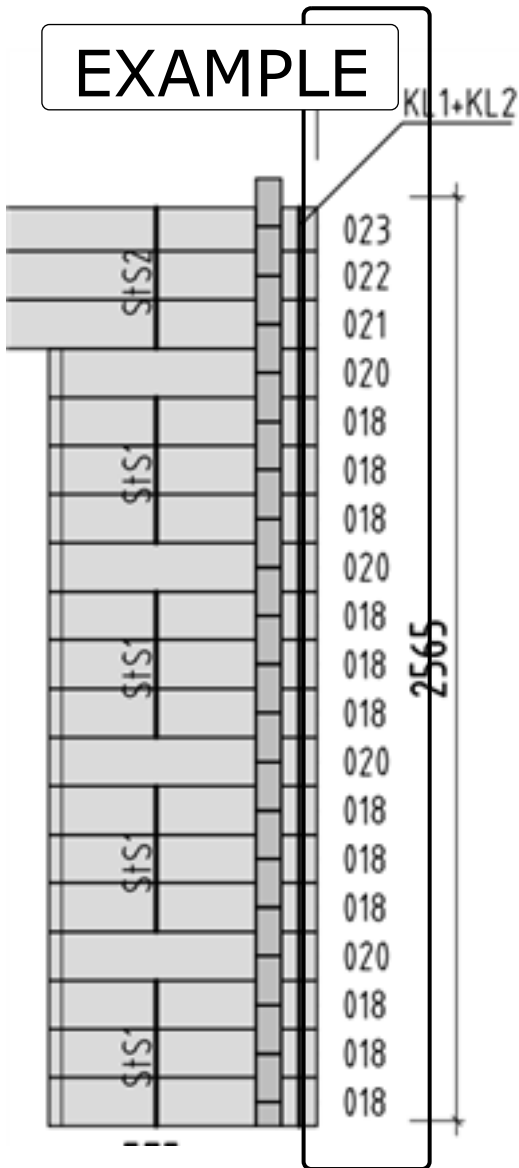

Pos	SPECIFICATION-STÜCKLISTE-NOMENCLATURE-ELEMENTI-ESPECIFICACIÓN PM70-5233	Pcs	Profile (mm)	Length (mm)
001		5	70x135	5200
002		7	70x135	5200
003		4	70x135	5200

EXAMPLE

Plan: 2...8 Log wall assembly

Positions: 001,002,...045,...

StS1, StS2,....

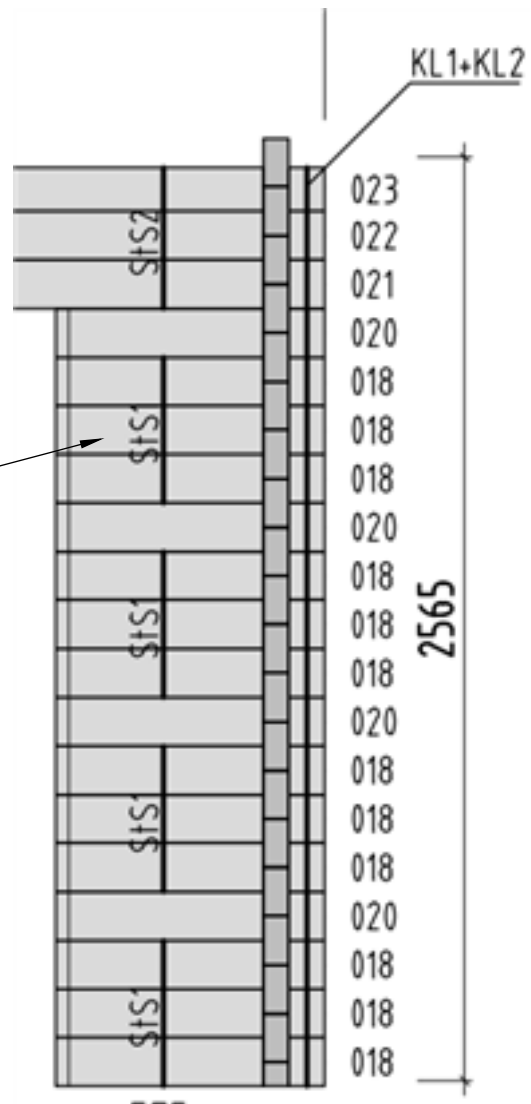
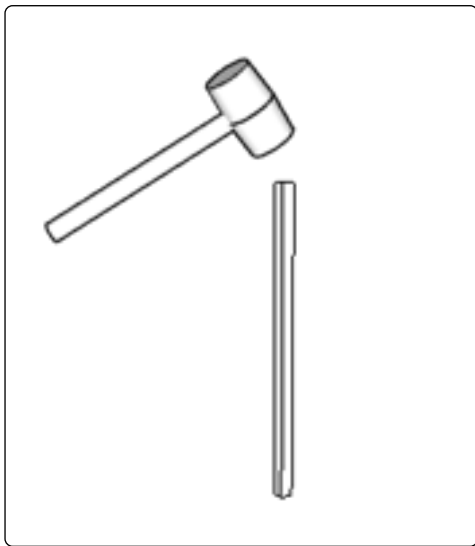

Plan: 2...8 Log wall assembly

Positions: 001,002,...045,..

(QMUPL10Zn)x4

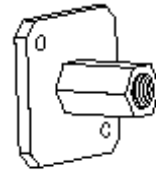

(QSE10Zn)x4



KL1, KL2,..



(QMUJ10Zn)x4



(QMUKK10Zn)x4

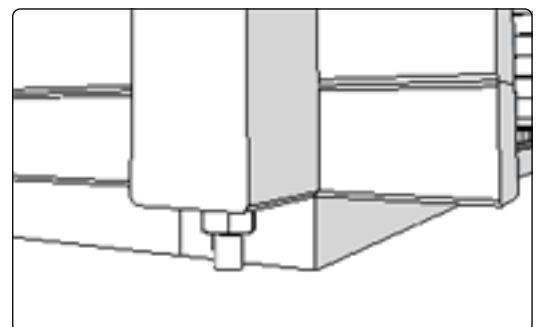
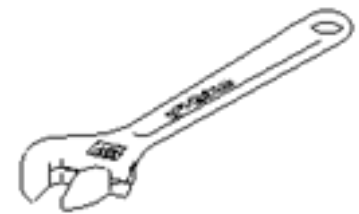
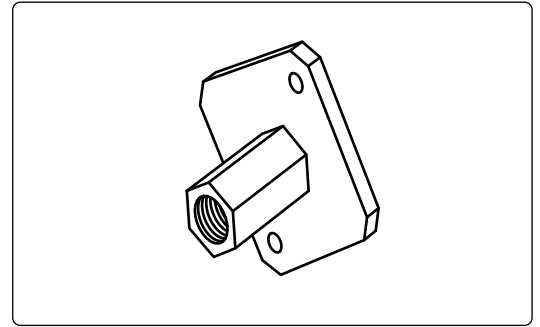
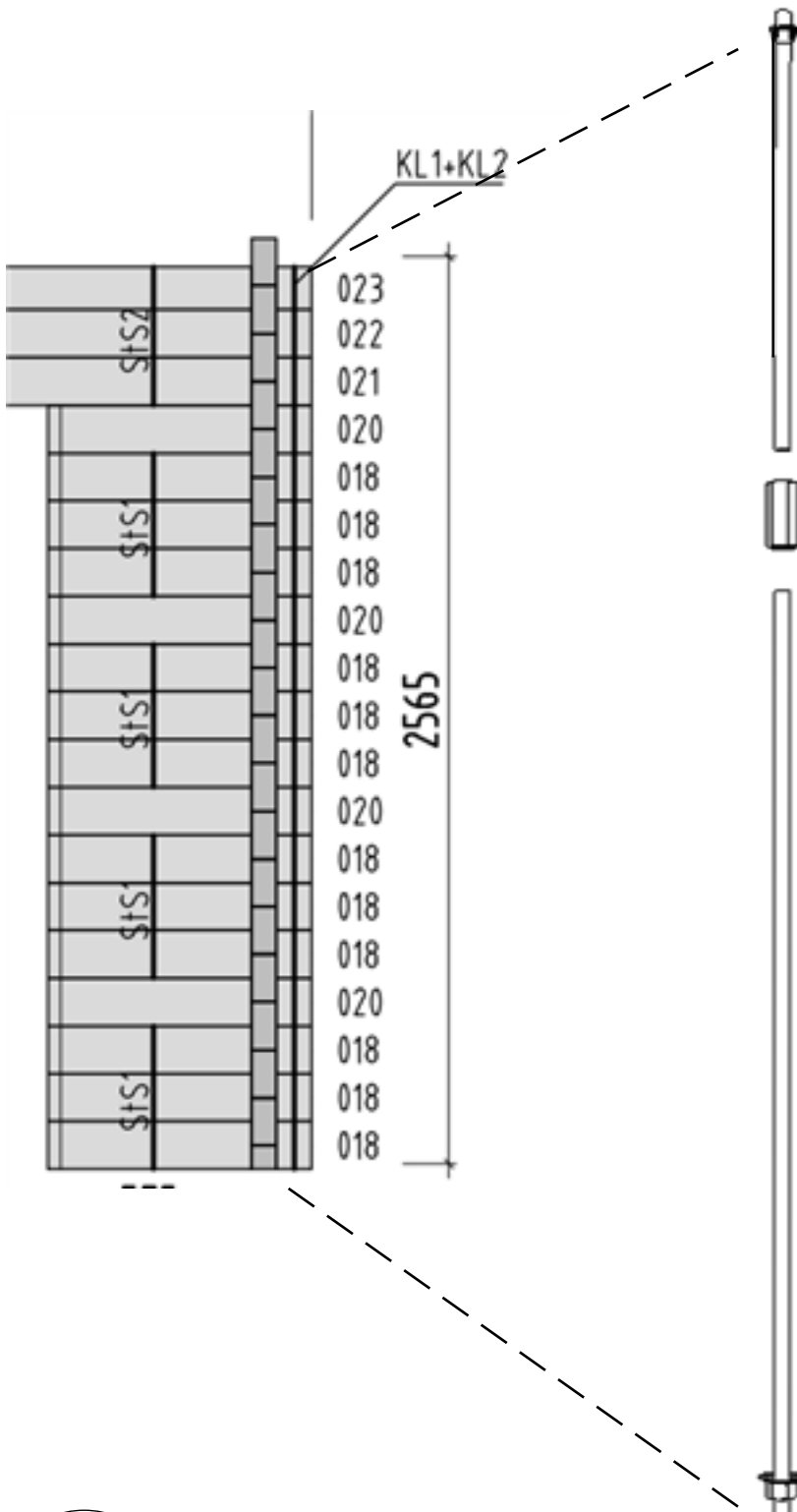

Plan: 8_3 WALL5

Positions: Pst

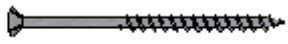

10 (QKRPP4_5X70Zn)

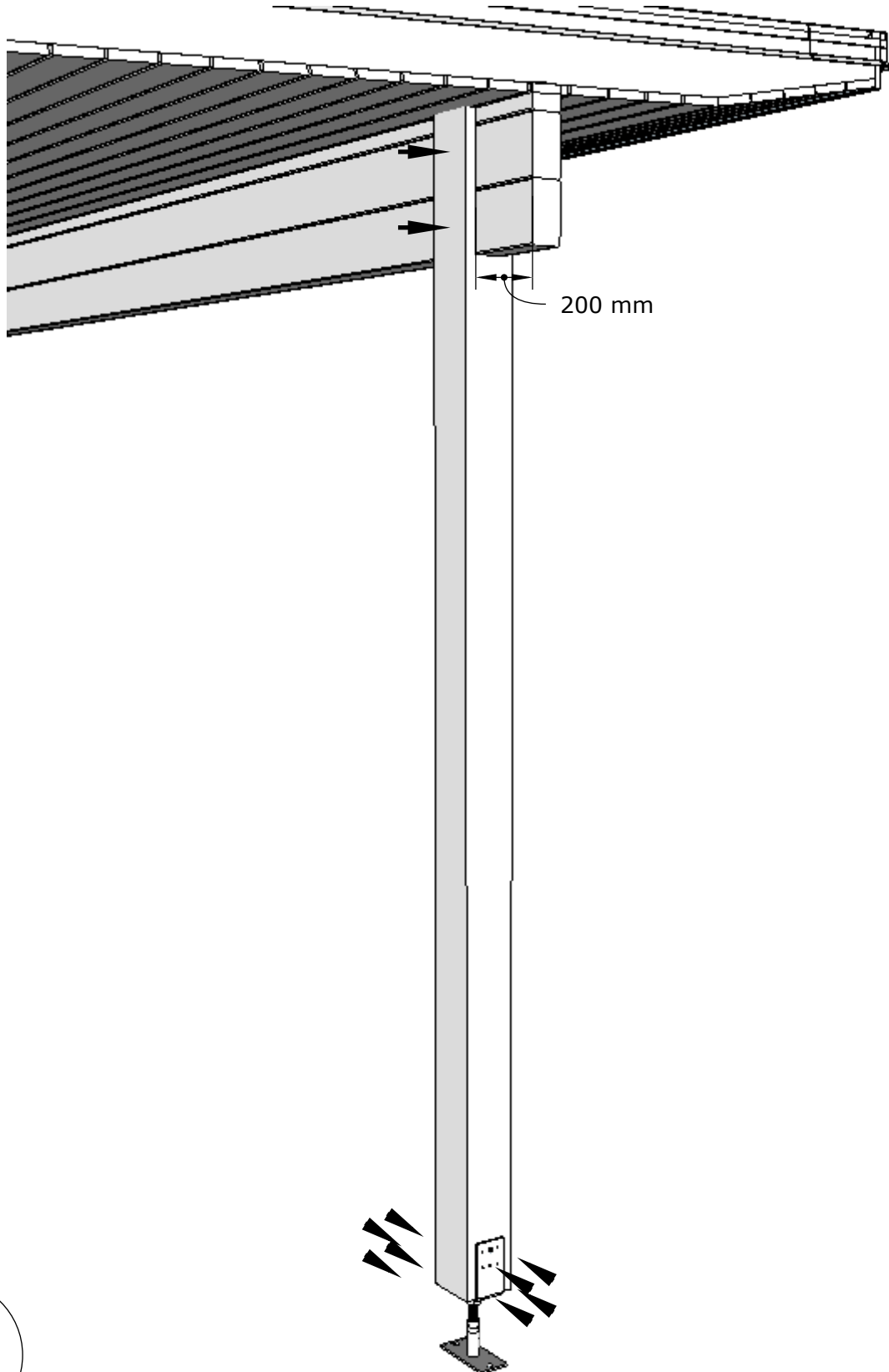
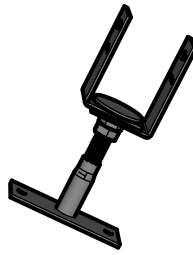

6

Plan: 9 Rafter plan
Positions: RoR1



QKRYP8x260Zn

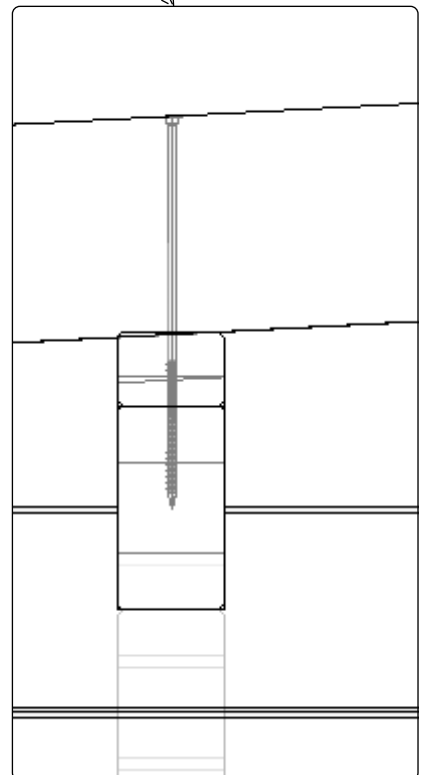
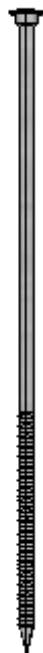
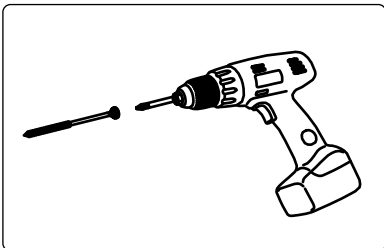
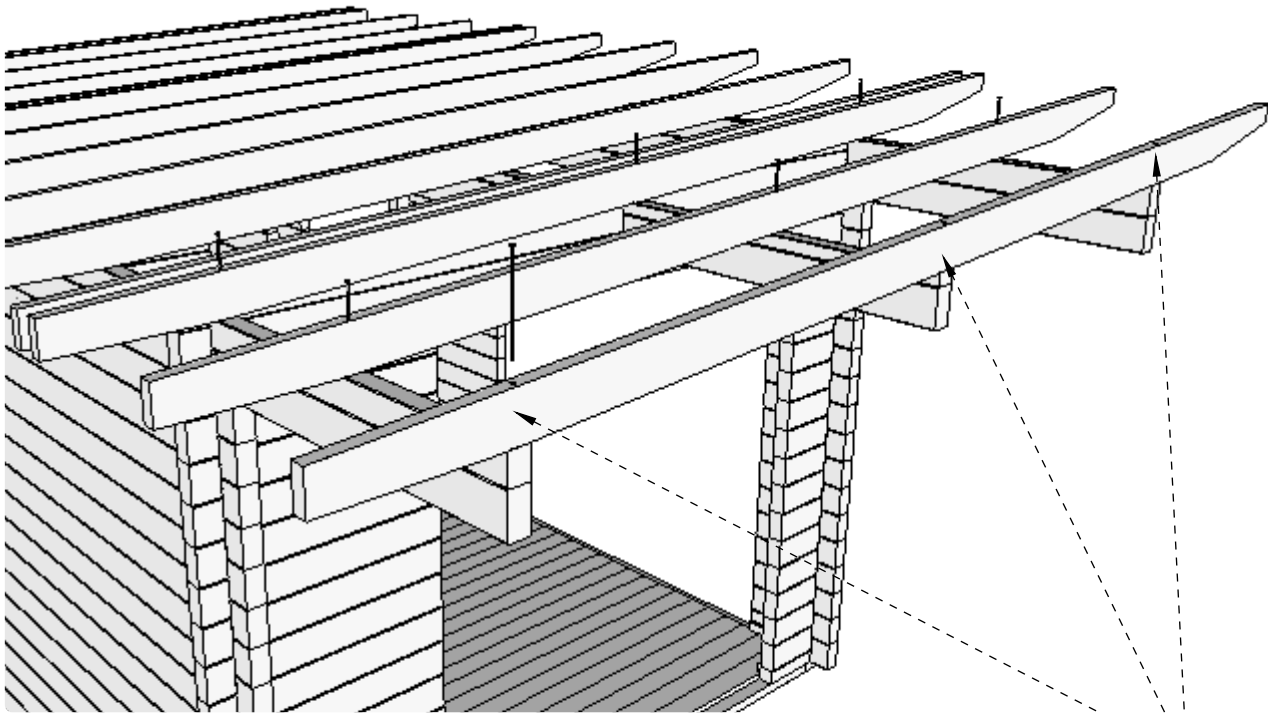

7

Plan: 9 Rafter plan

Positions: RoR1

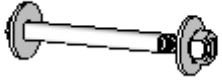

QPOKK8X60ZN

QSE8X28ZN

QMUKK8ZN

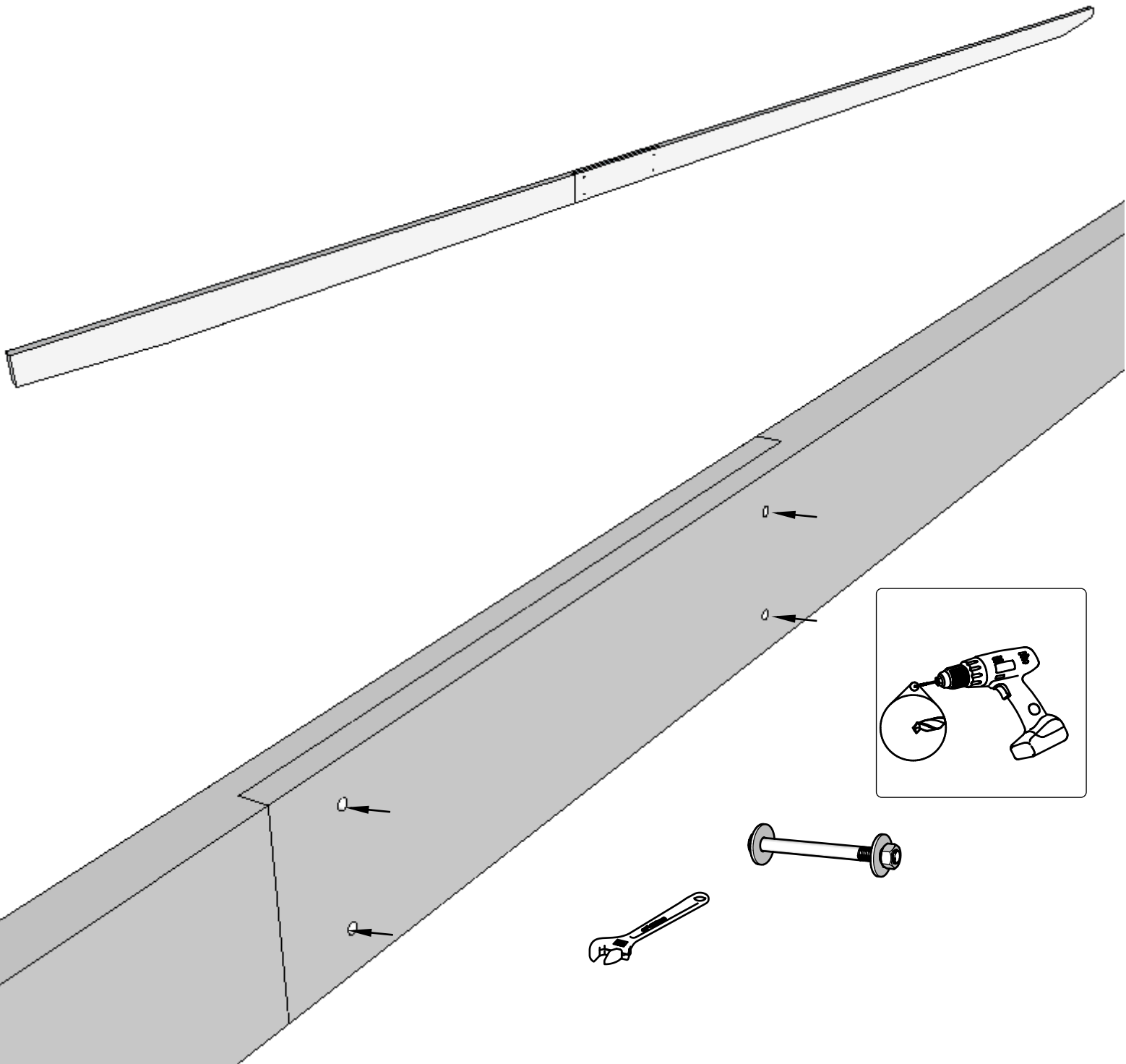

Plan: 9 Rafter plan

Positions: RoR2



RoR2

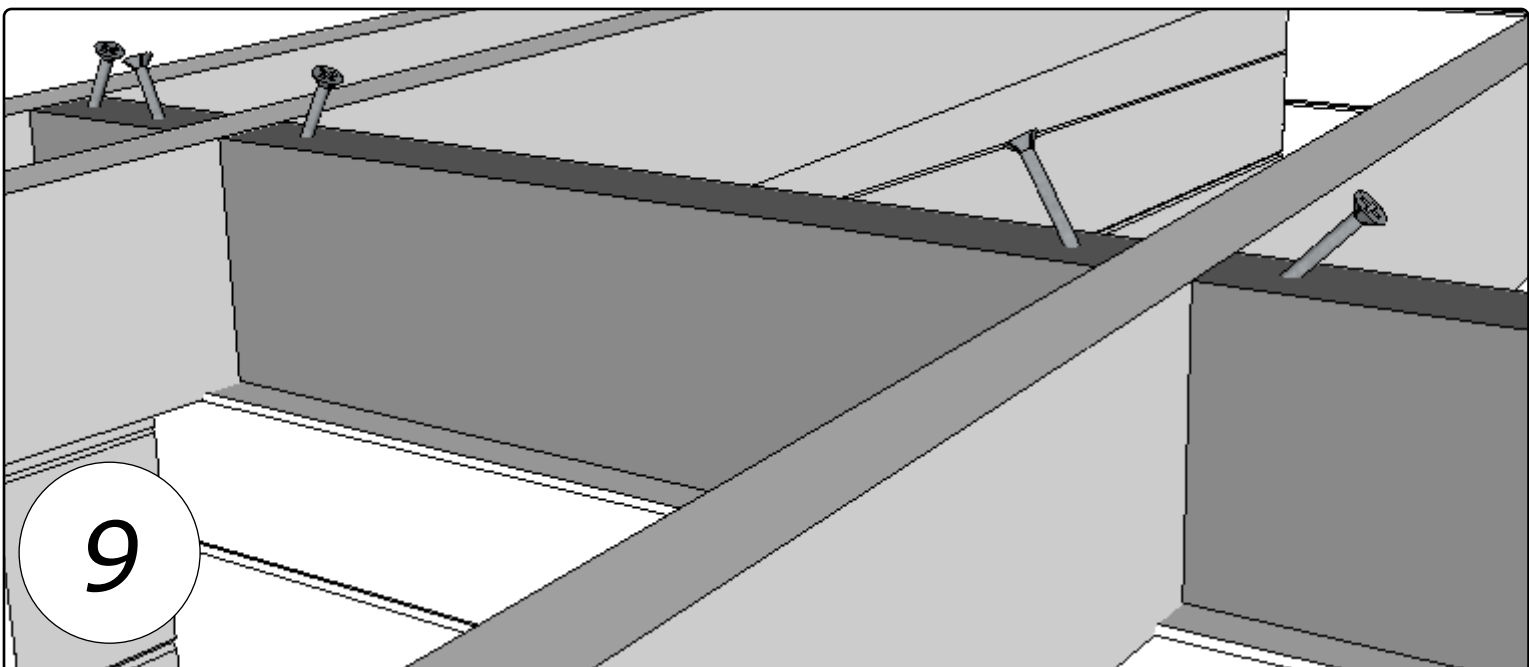
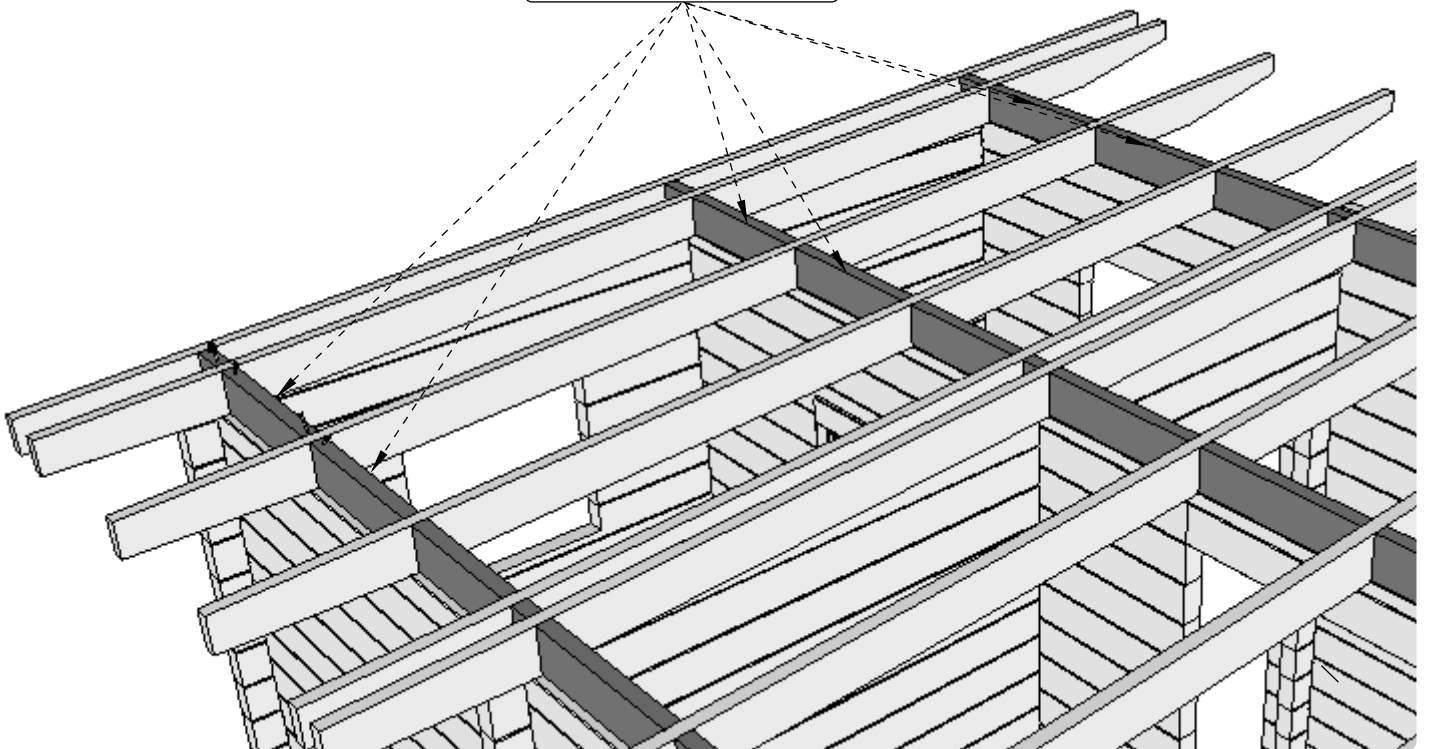
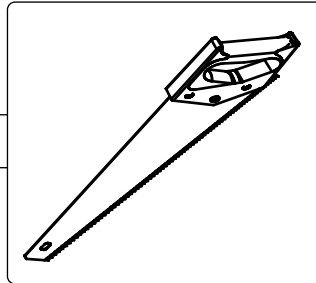

Plan: 10 Roof plan
Positions: RB2-1, RB2 - 2

 QNA2_2x50Zn

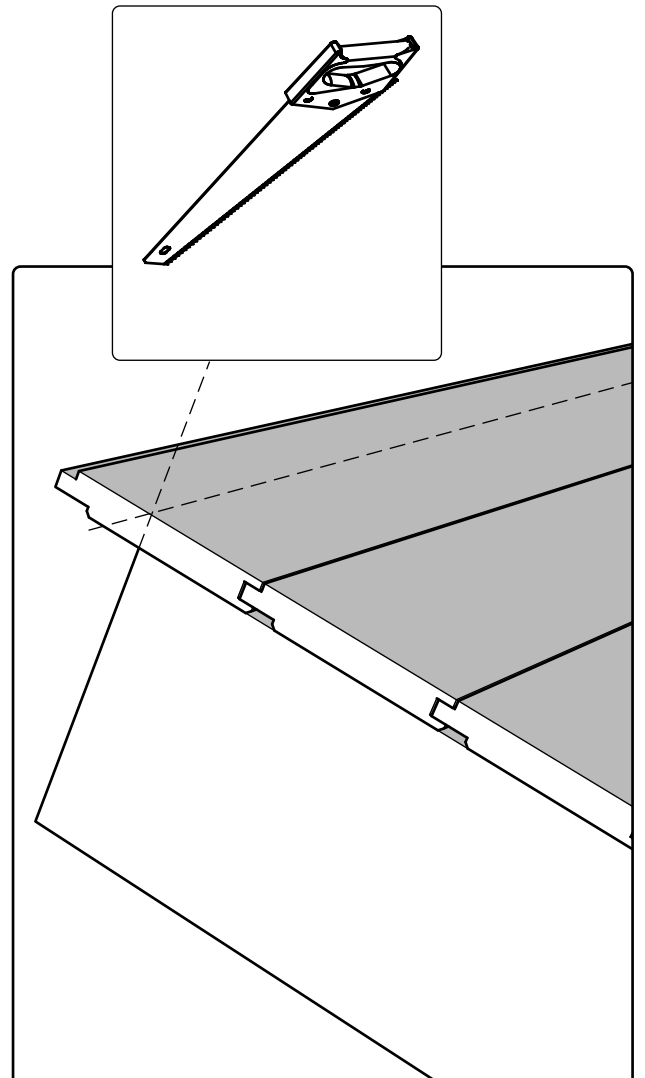
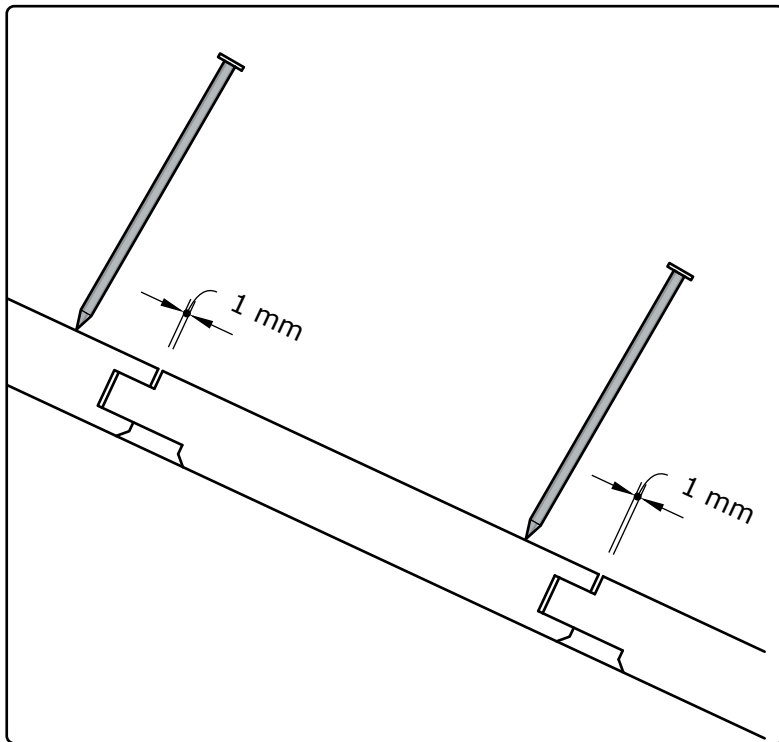
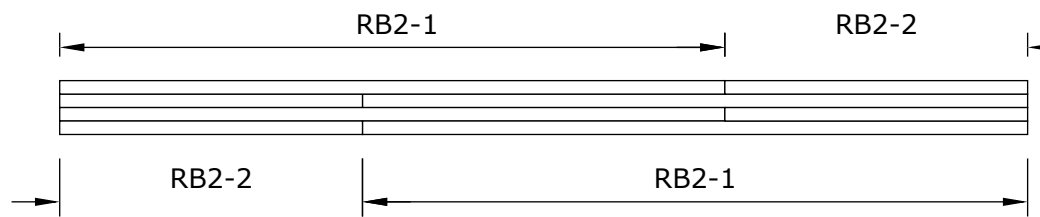
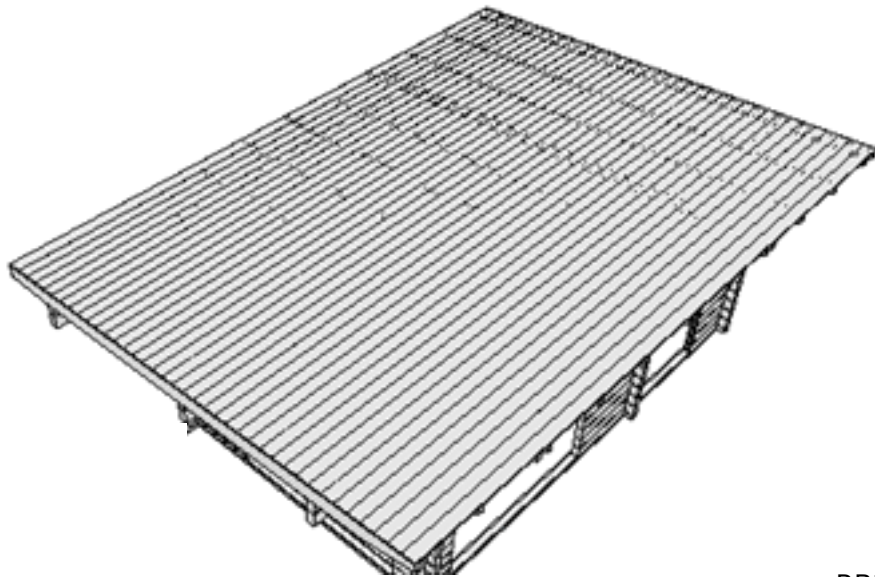

10

Plan: 11 Roof overhang boarding plan

Positions: TB3-1, TB3-2, TB3-3, EaE1, EaE2, EaE3, EaE4

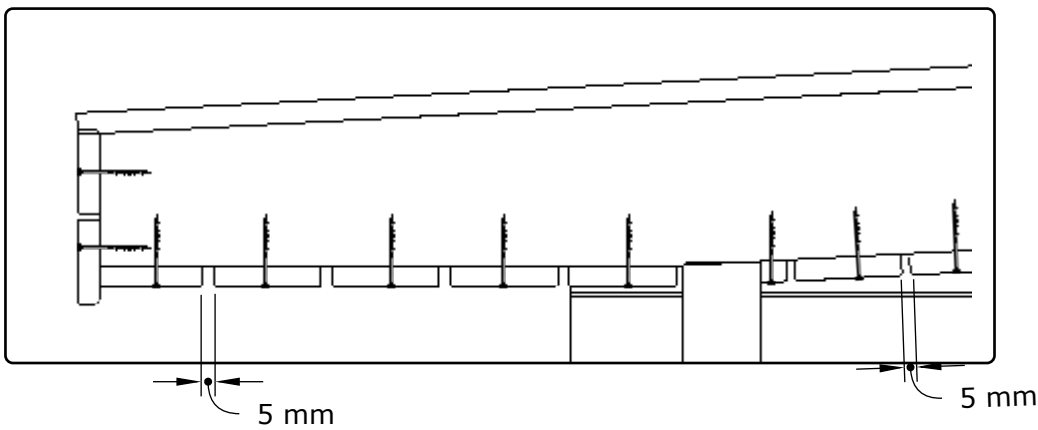
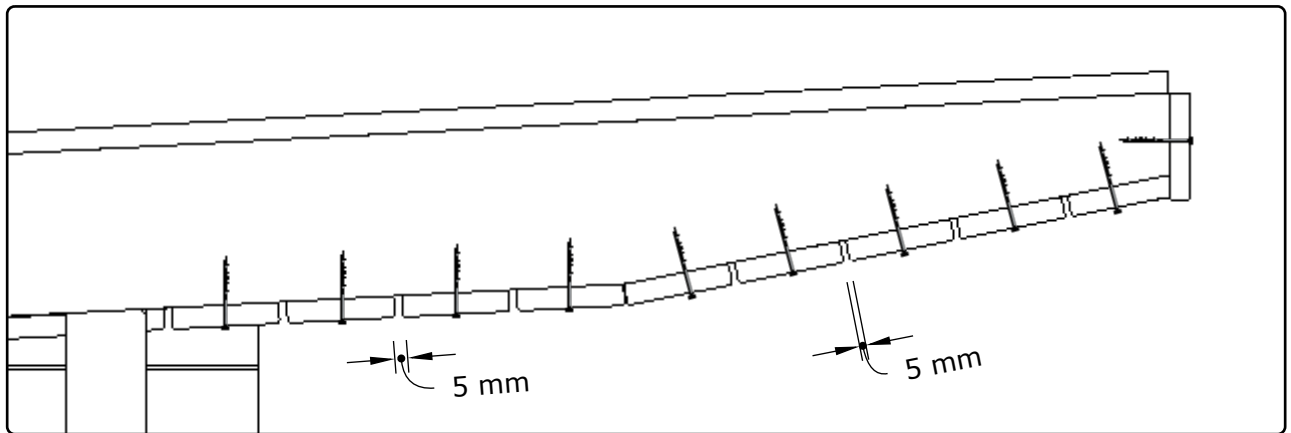
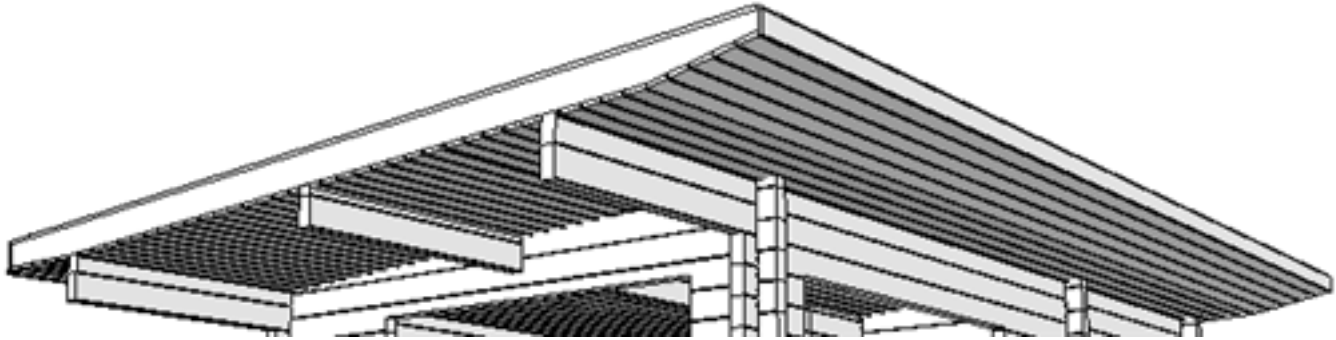

Plan: 11 Roof
Positions:

QP151x52_4x2000MU

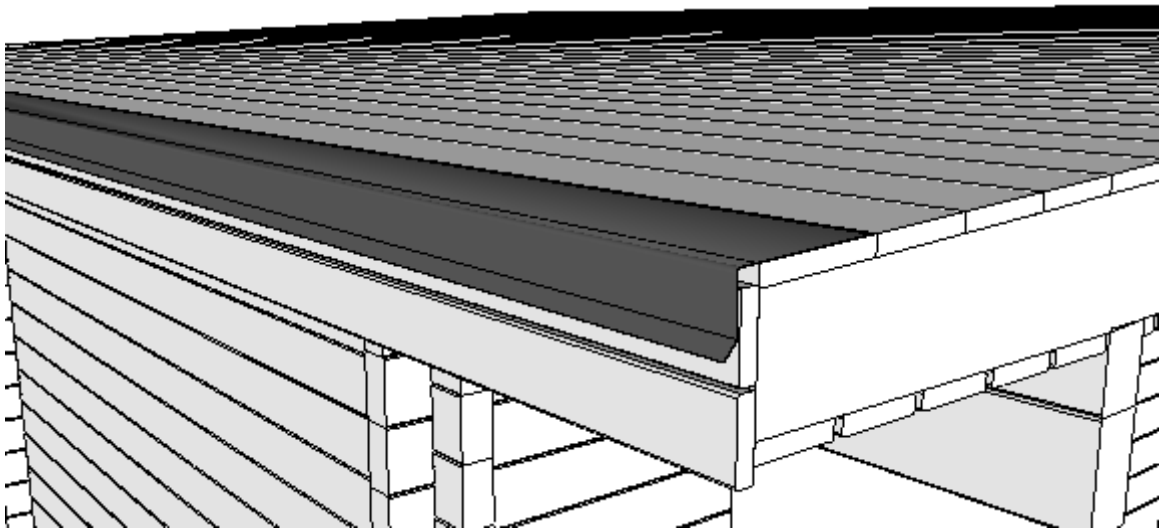
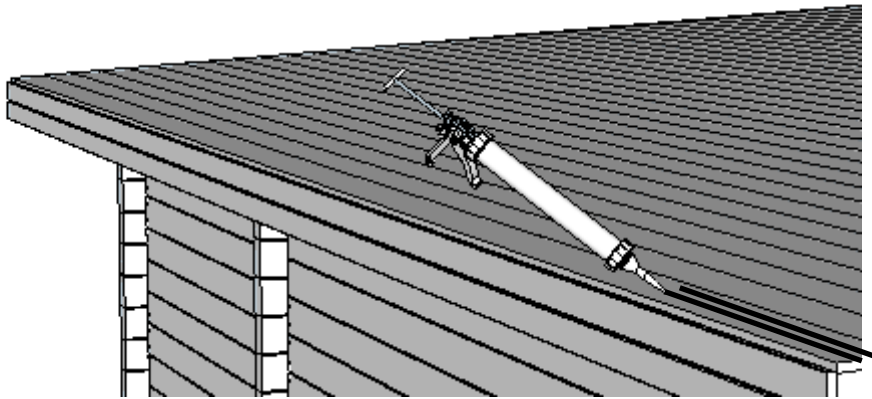
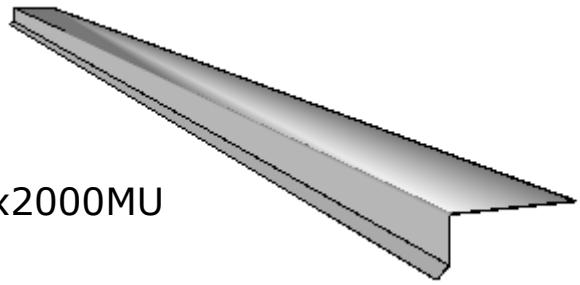

EPDM optional

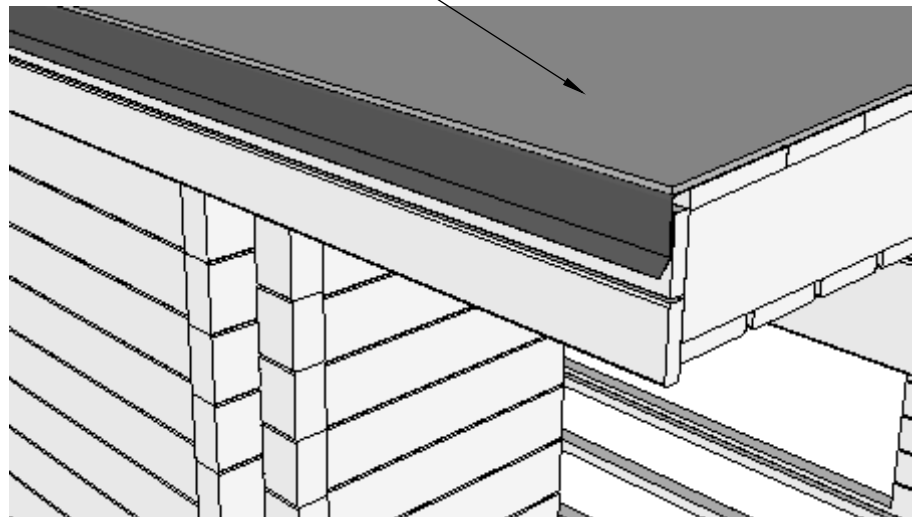

Plan: 11 Roof
Positions:

QKRKK4_8X28MU



QP151x52_4x2000MU

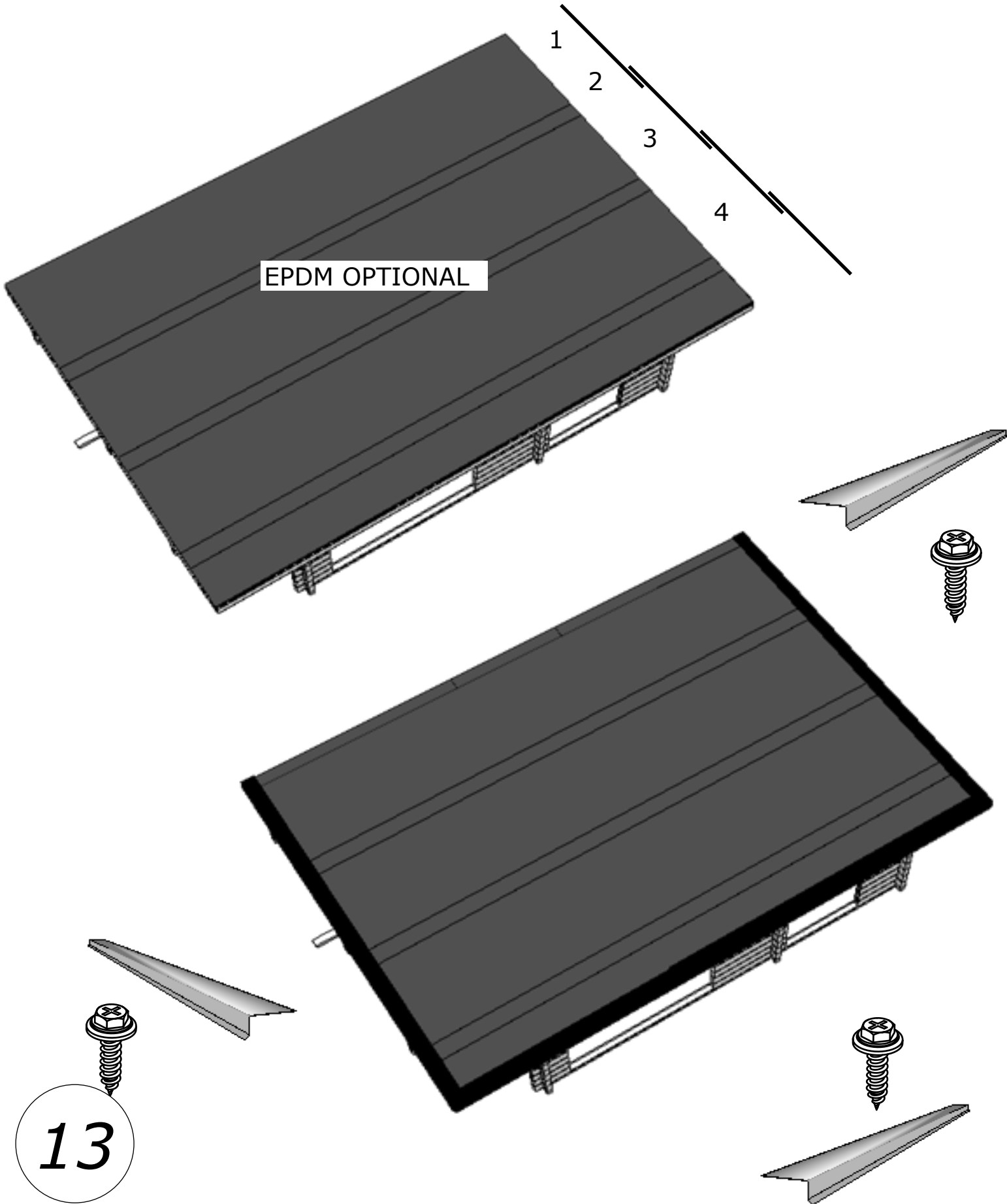
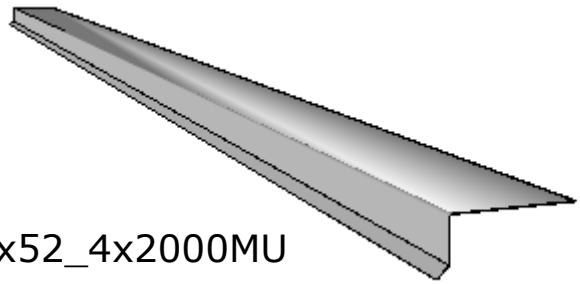

EPDM OPTIONAL

- 1
- 2
- 3
- 4

13

Plan: 11 Roof
Positions:

QKRKK4_8X28MU



QP151x52_4x2000MU

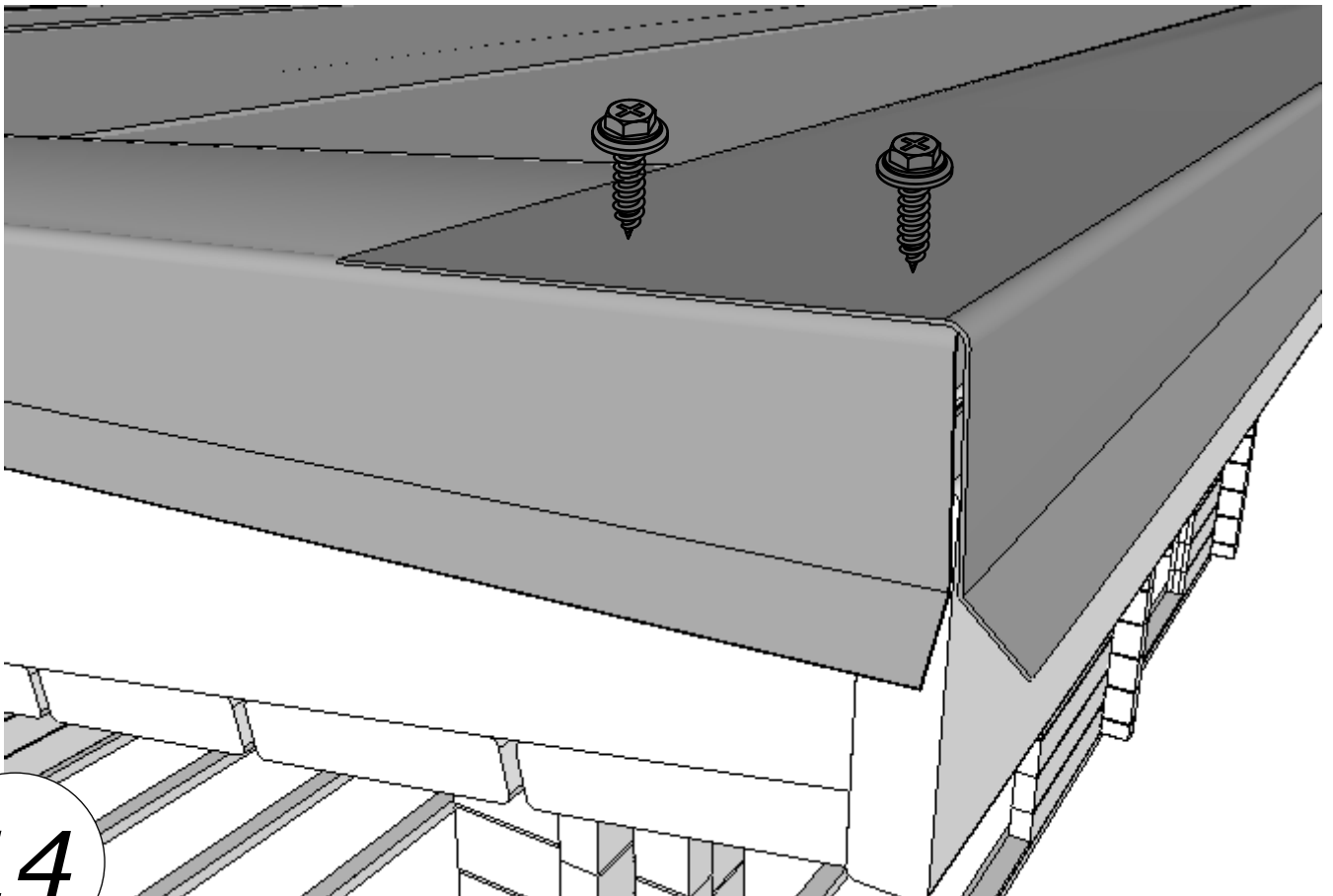
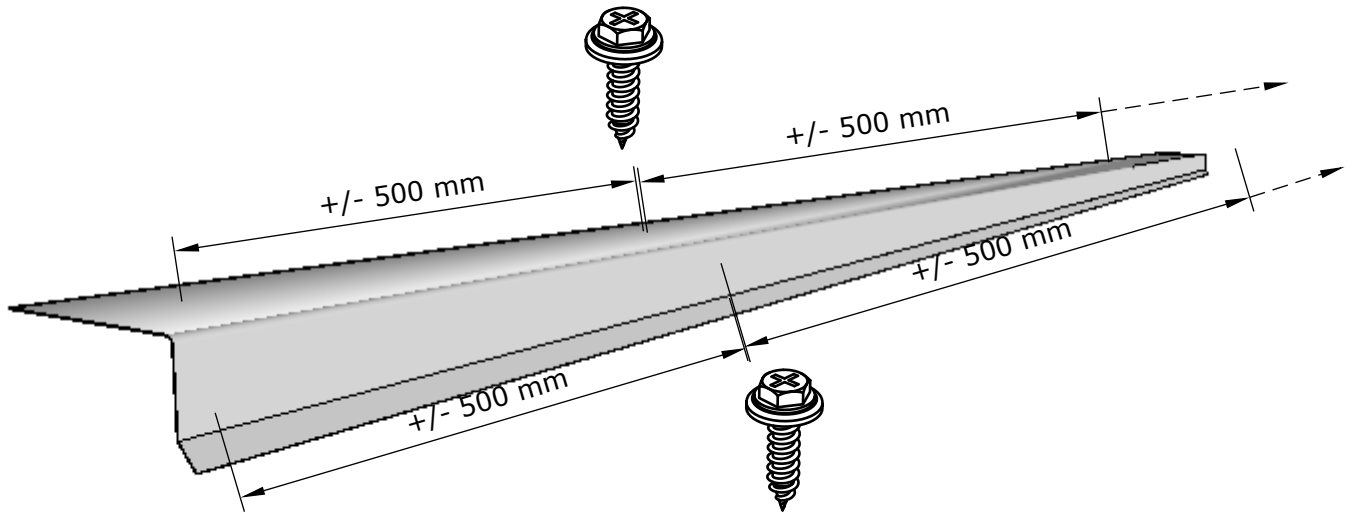
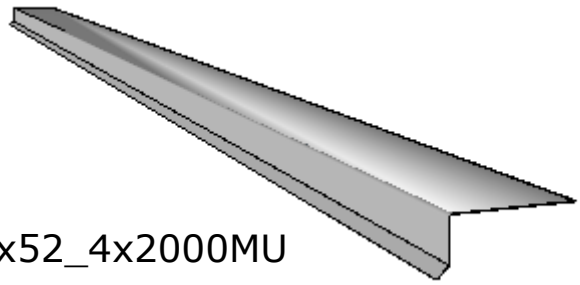

Plan: 9 Rafter plan
Positions:

Recommanded, NOT included

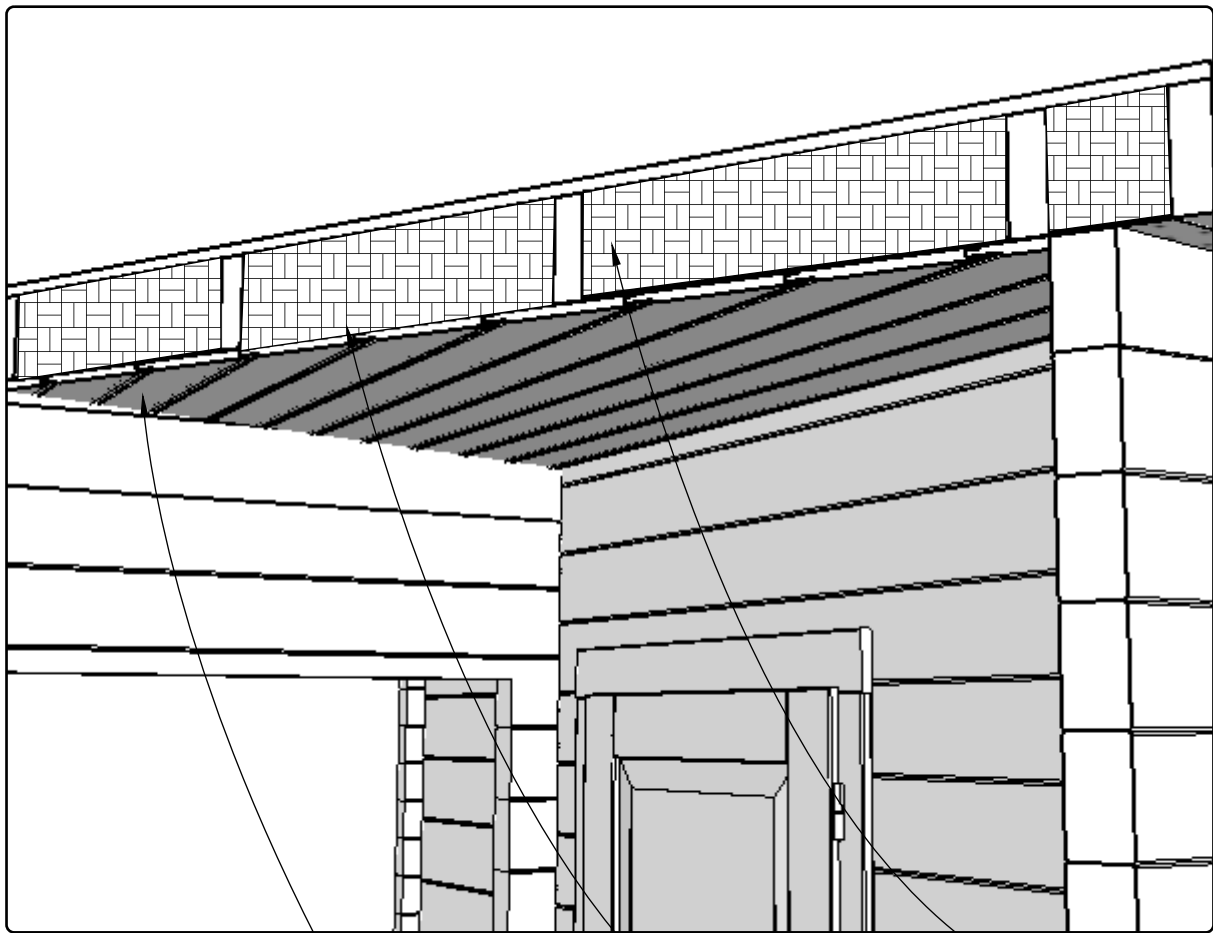

• Insulation NOT INCLUDED

• Vapor barrier NOT INCLUDED

• Ceiling boarding NOT INCLUDED

Plan: 12 Floor board plan

Positions: 2FB3-1, 2FB3-2, 2FB3-2, FIB3-1

 QNA2_3x70Zn

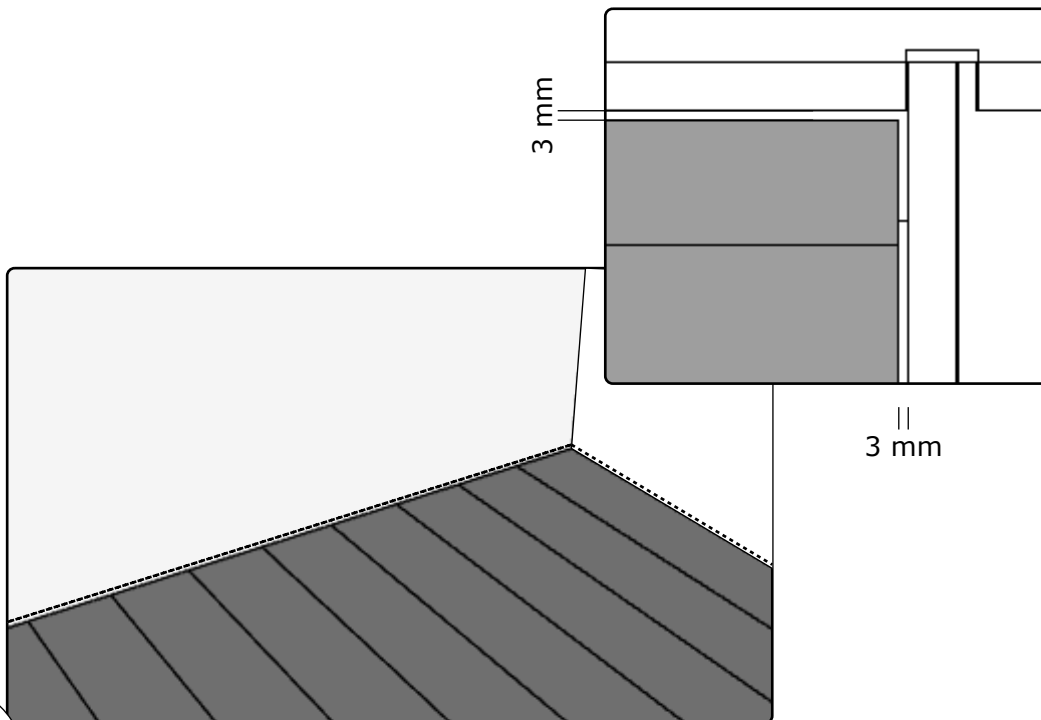
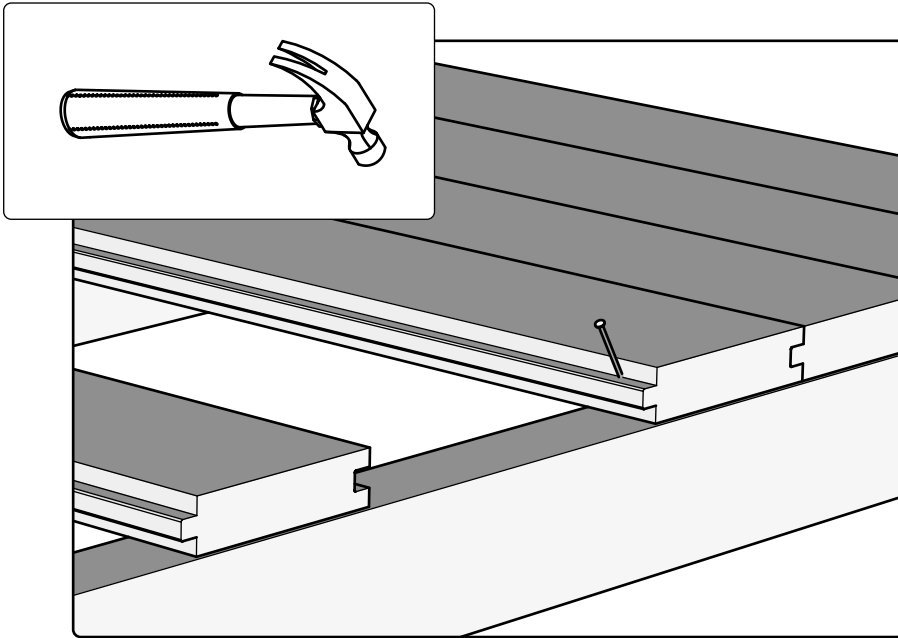

Plan: 13, 14, 15 Doors - Windows
Positions:

Plan: 14
Positions: TU51



Exterior



I

Plan: 13-C ASI-15-7016
Positions:

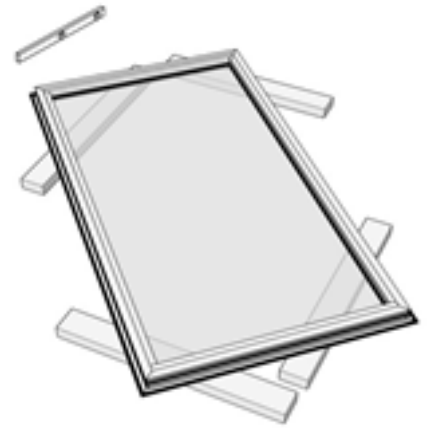

I

Plan: 13
Positions: ASI-13

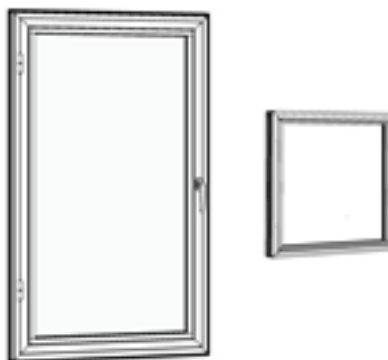

I

Plan: 15-A LU104-5P-7016
Positions:



17

Plan: 15
Positions: LU59-5P-7016



I

Plan: 16 Doors INSIDE
Positions: U71

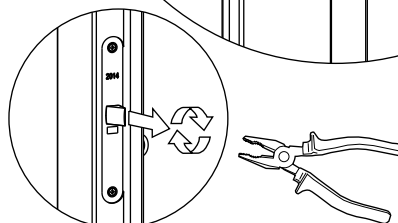
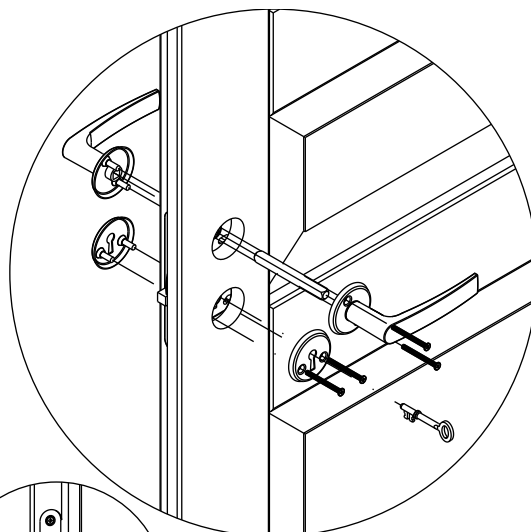
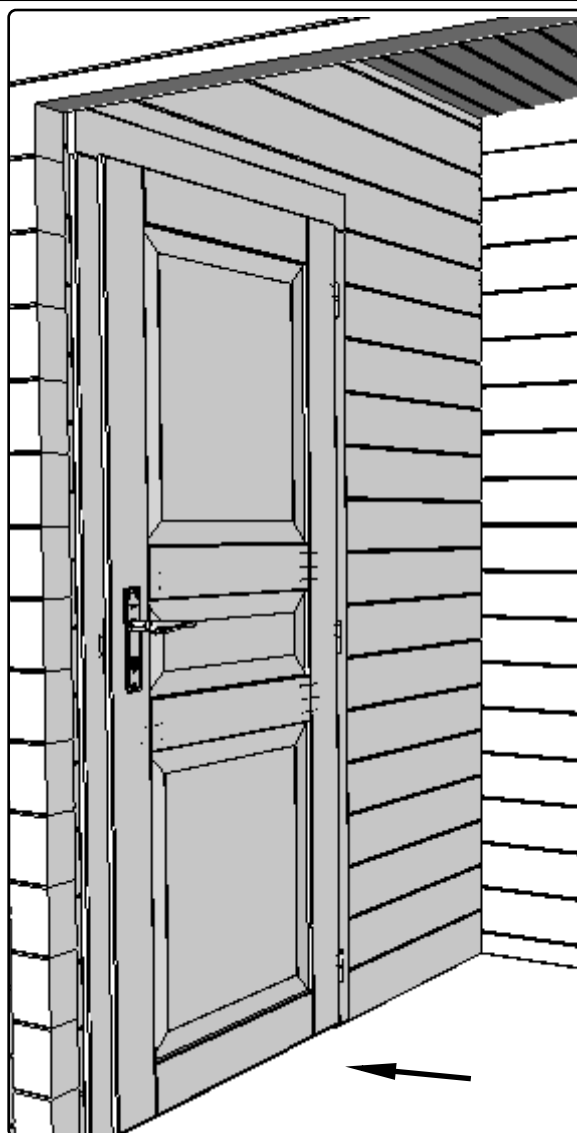
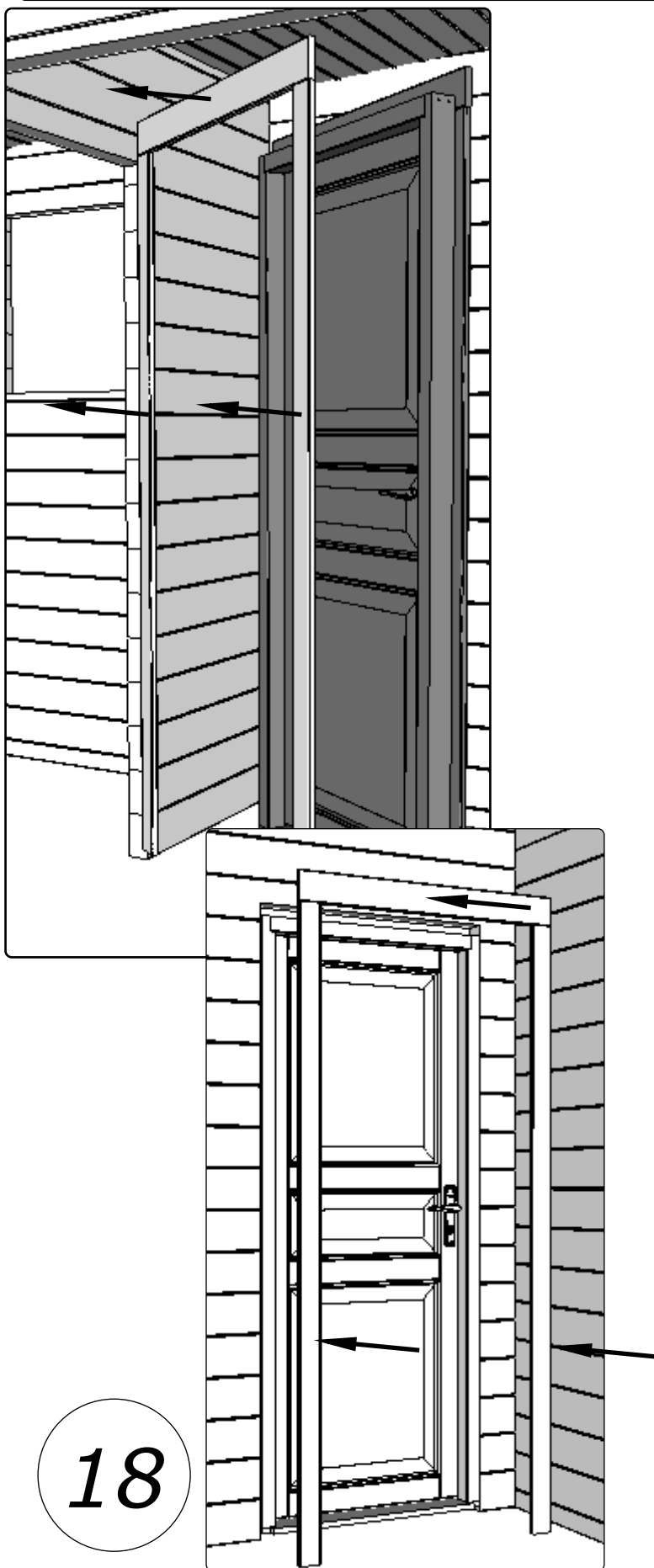

Plan: 17 Zalusii
Positions:

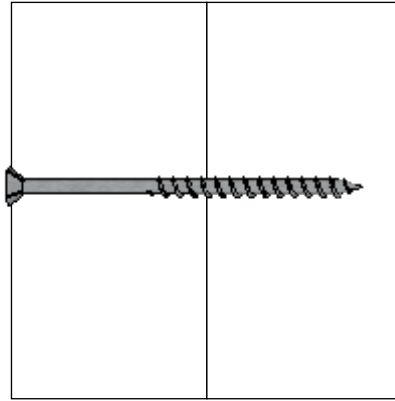
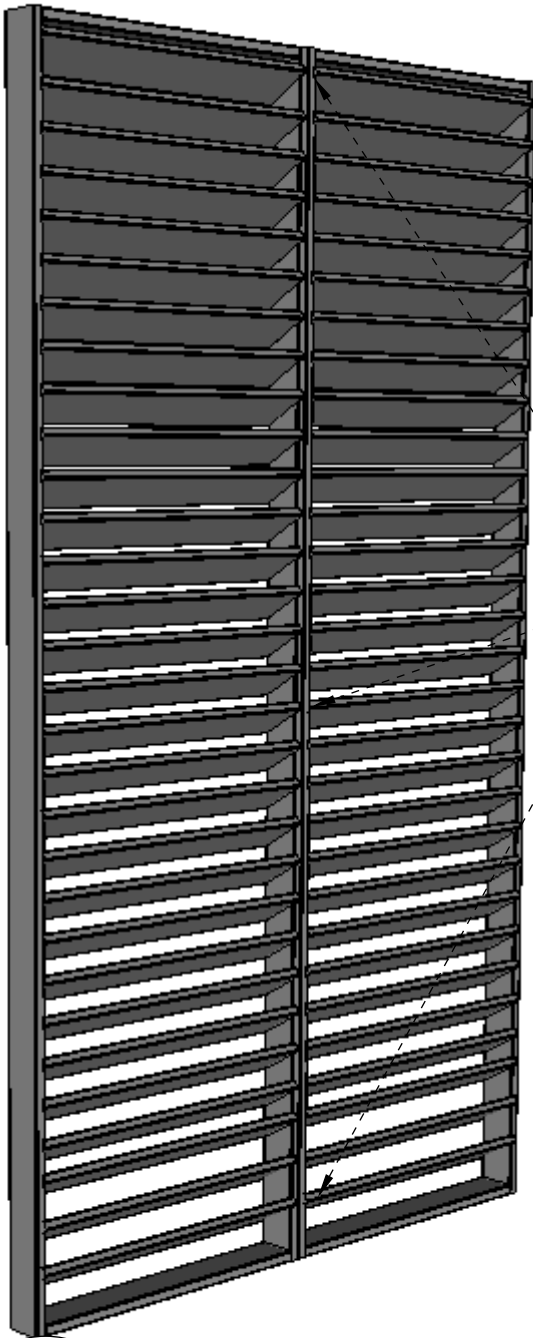
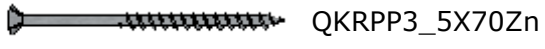

Plan: 17 Zalusii
Positions:

QNU35x35x130Zn

 QKRYP5X40ZnTX

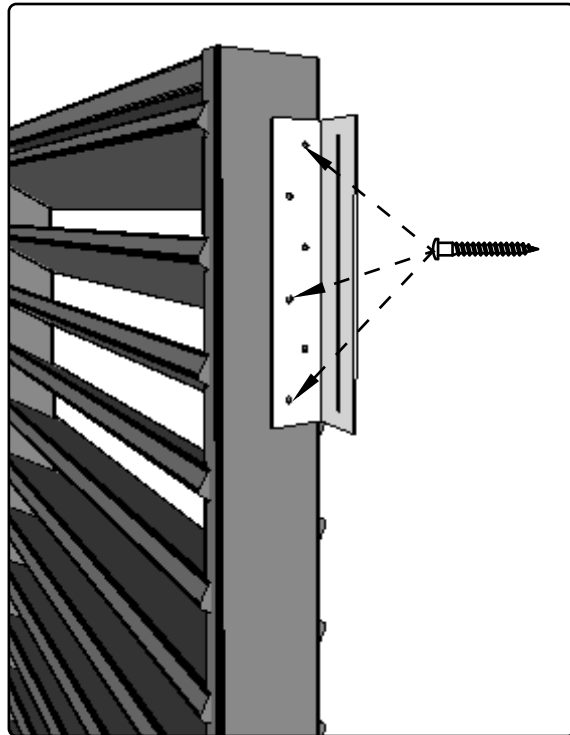
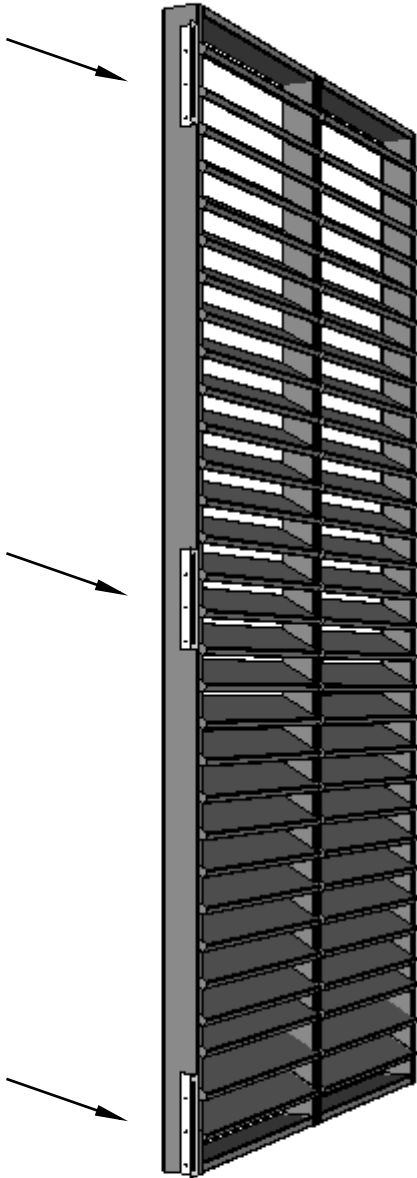

Plan: 17 Zalusii
Positions:

QNU35x35x130Zn



QKRKK8X30Zn

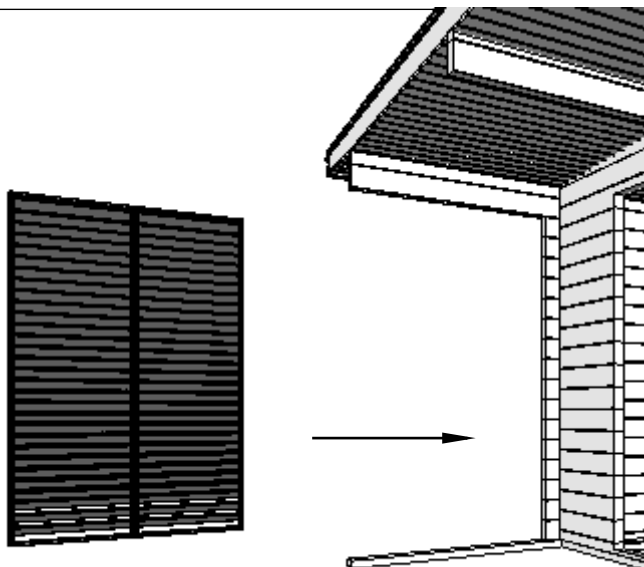

21

Plan: 17 Zalusii

Positions:

 QKRYP5X40ZnTX

 QKRKK8X30Zn

 QKRPP3_5X70Zn

QNU50x60x130Zn

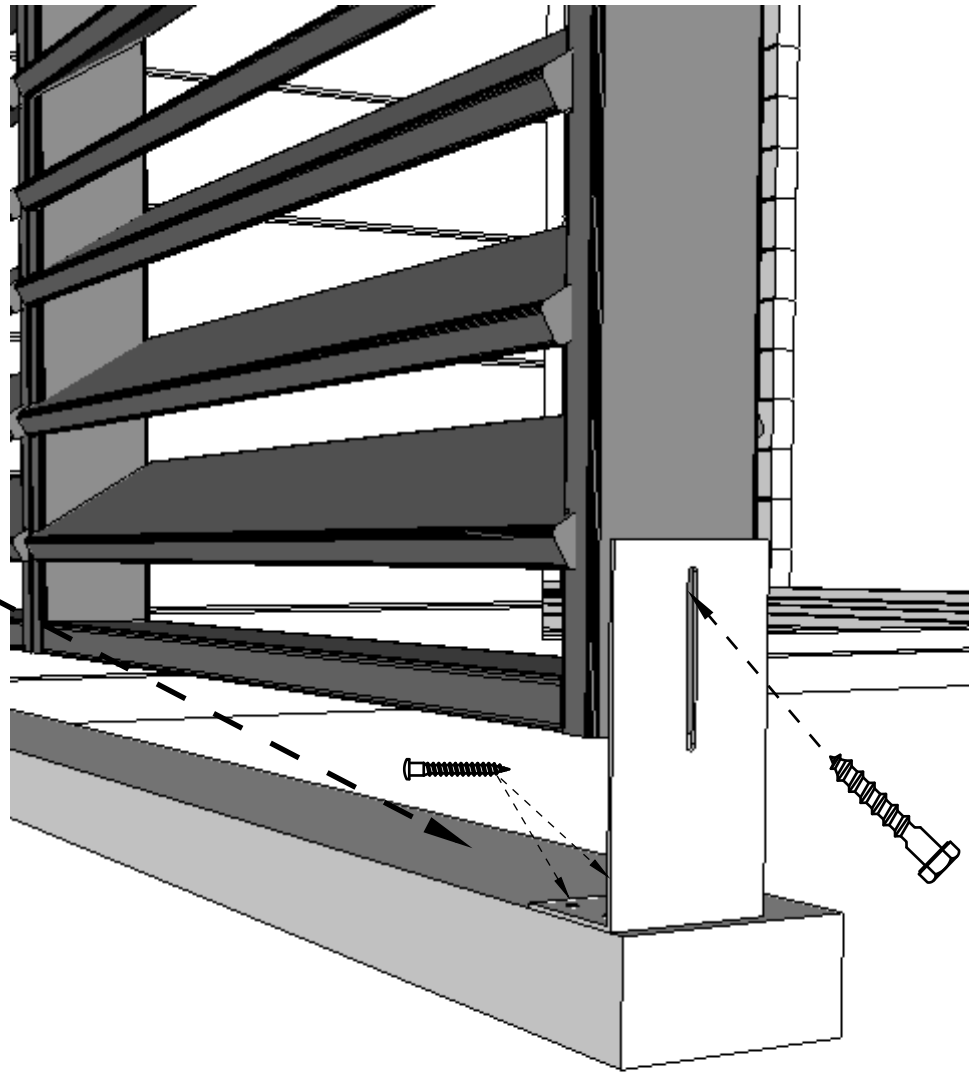
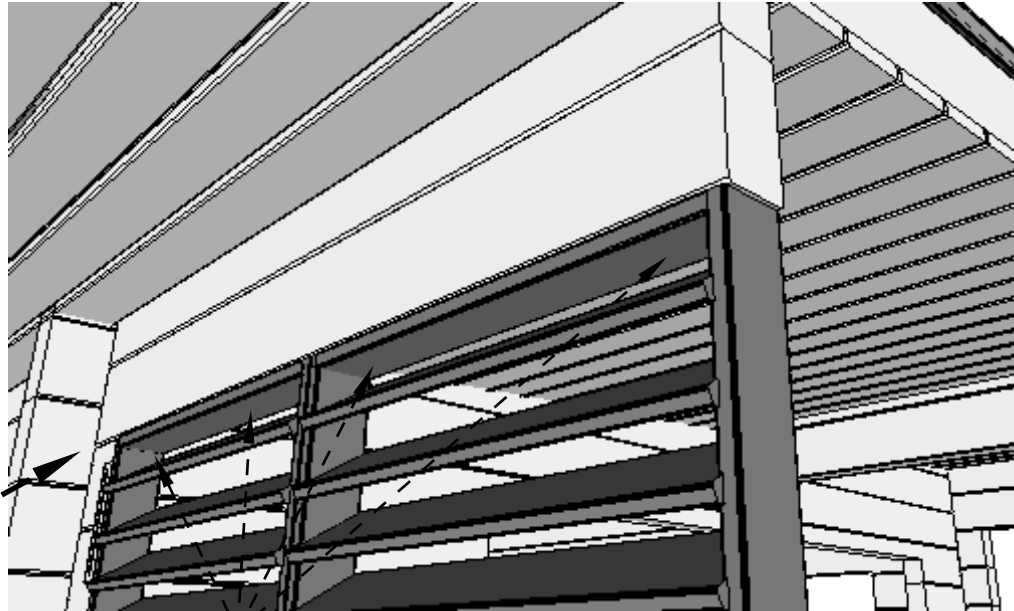
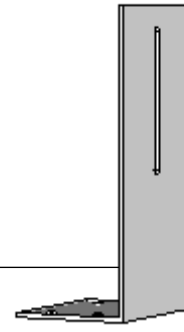

Plan: 15 LU59-5P-7016

Positions:

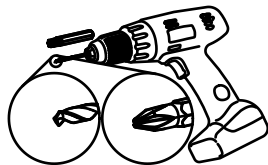
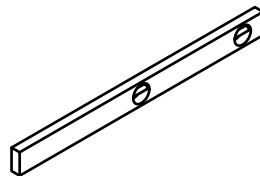
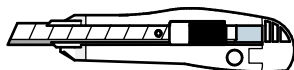
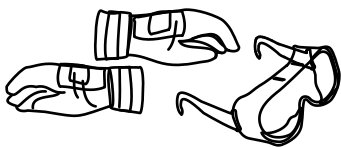

I

Plan: 15 LU59-5P-7016

Positions:

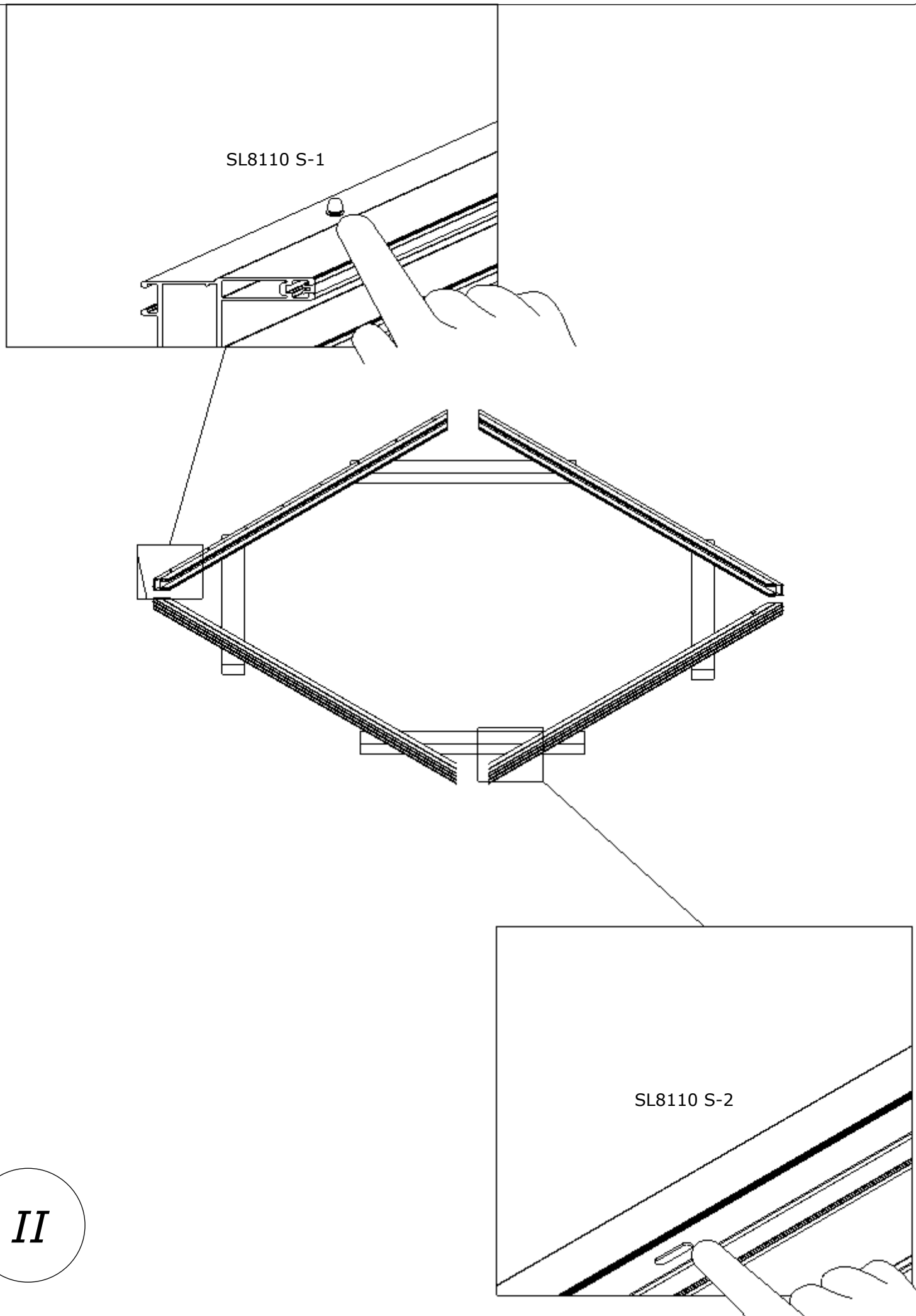

Plan: 15 LU59-5P-7016

Positions:

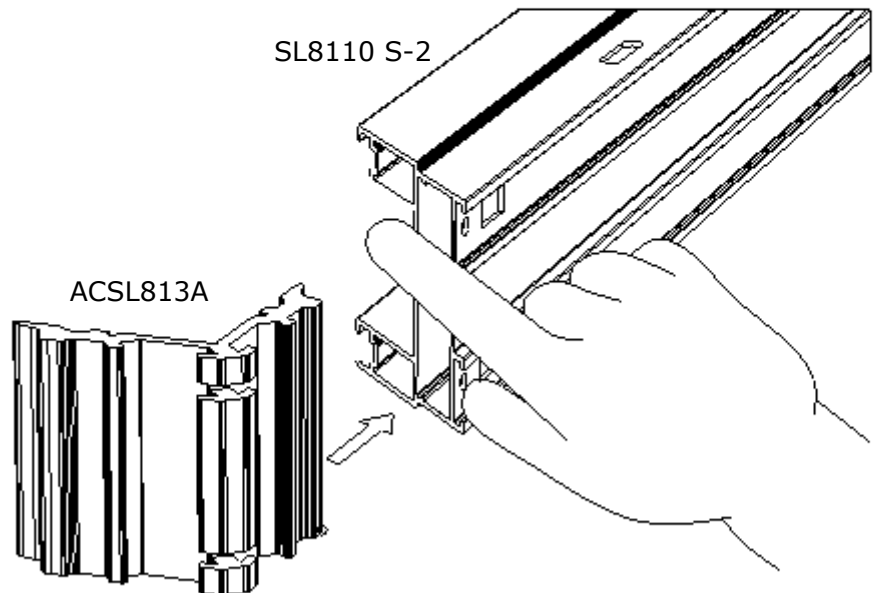
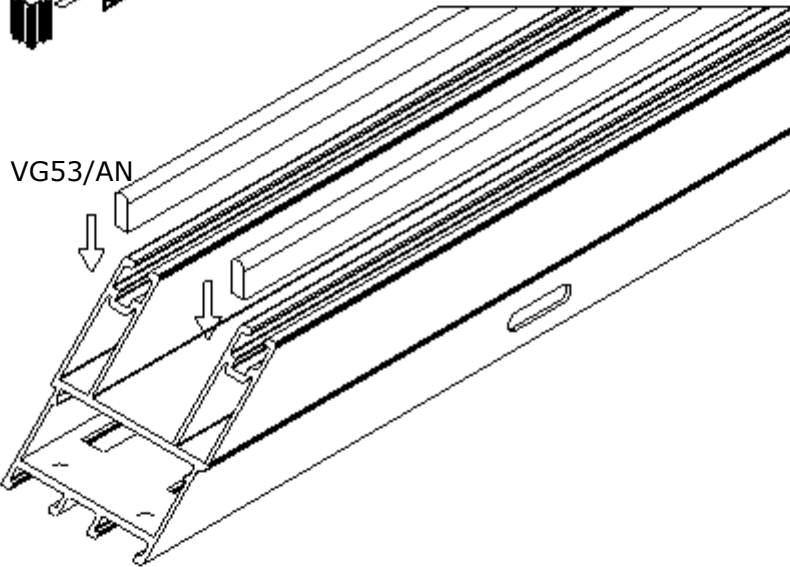
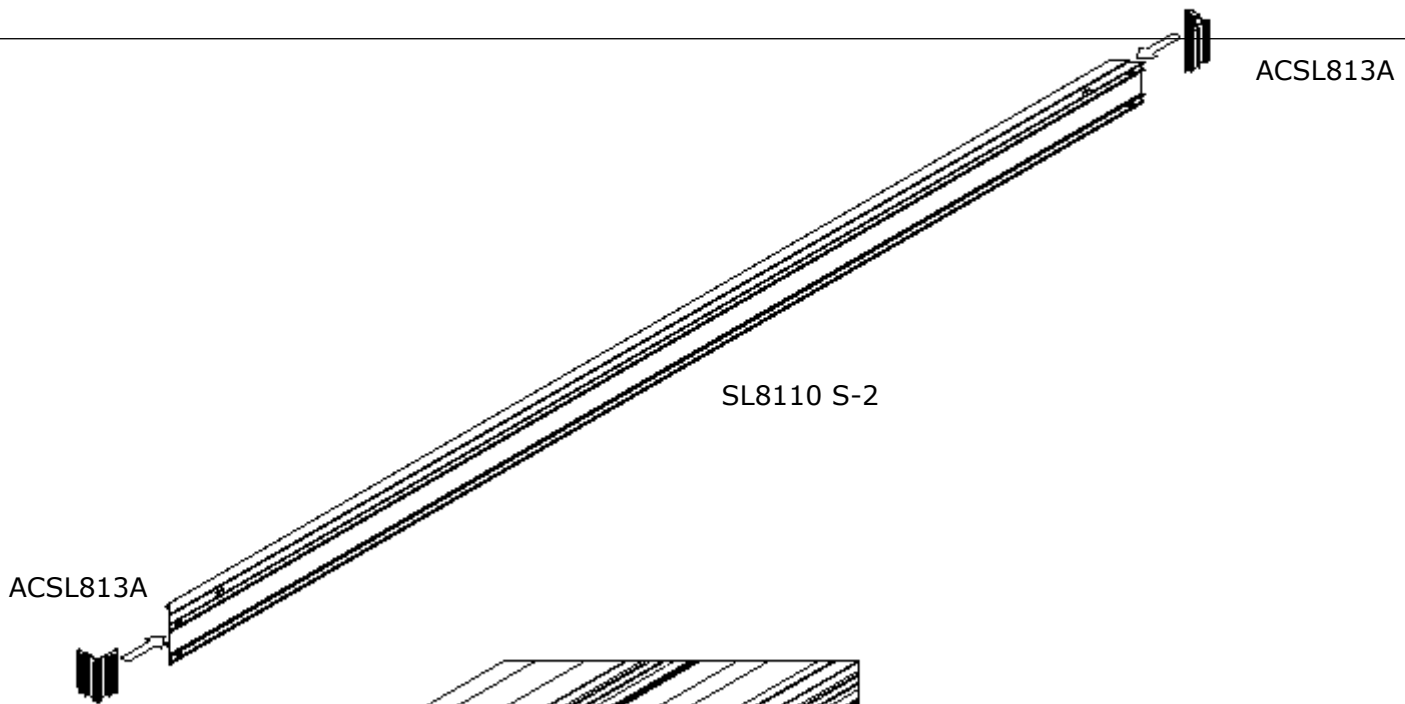

Plan: 15 LU59-5P-7016

Positions:

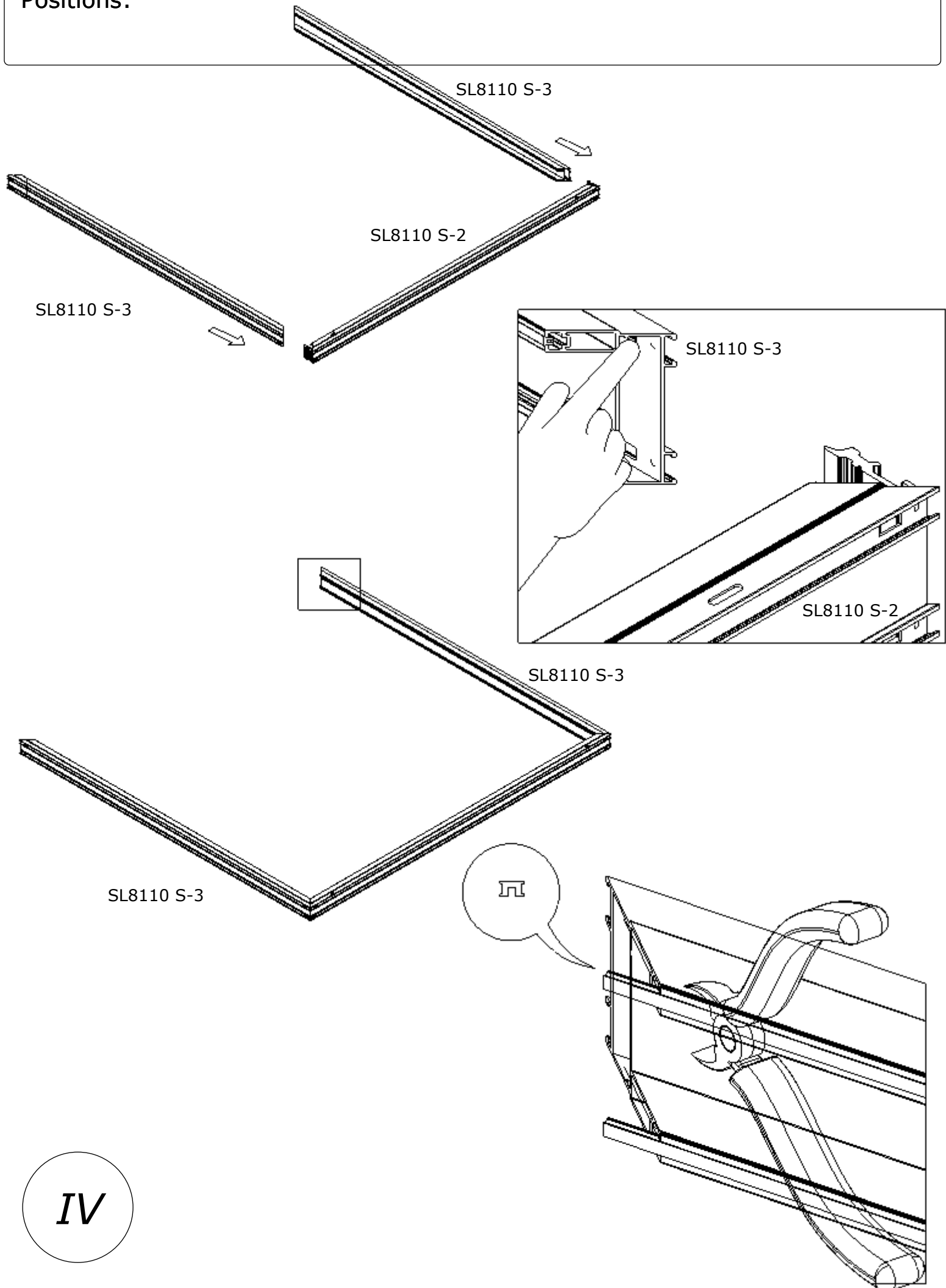

IV

Plan: 15 LU59-5P-7016

Positions:



ACSL813A

SL8110 S-1

ACSL813A

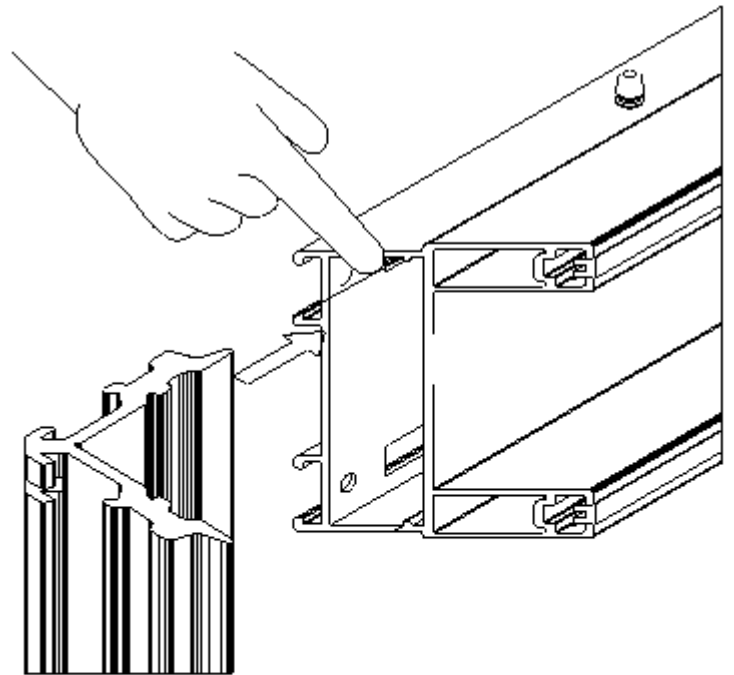
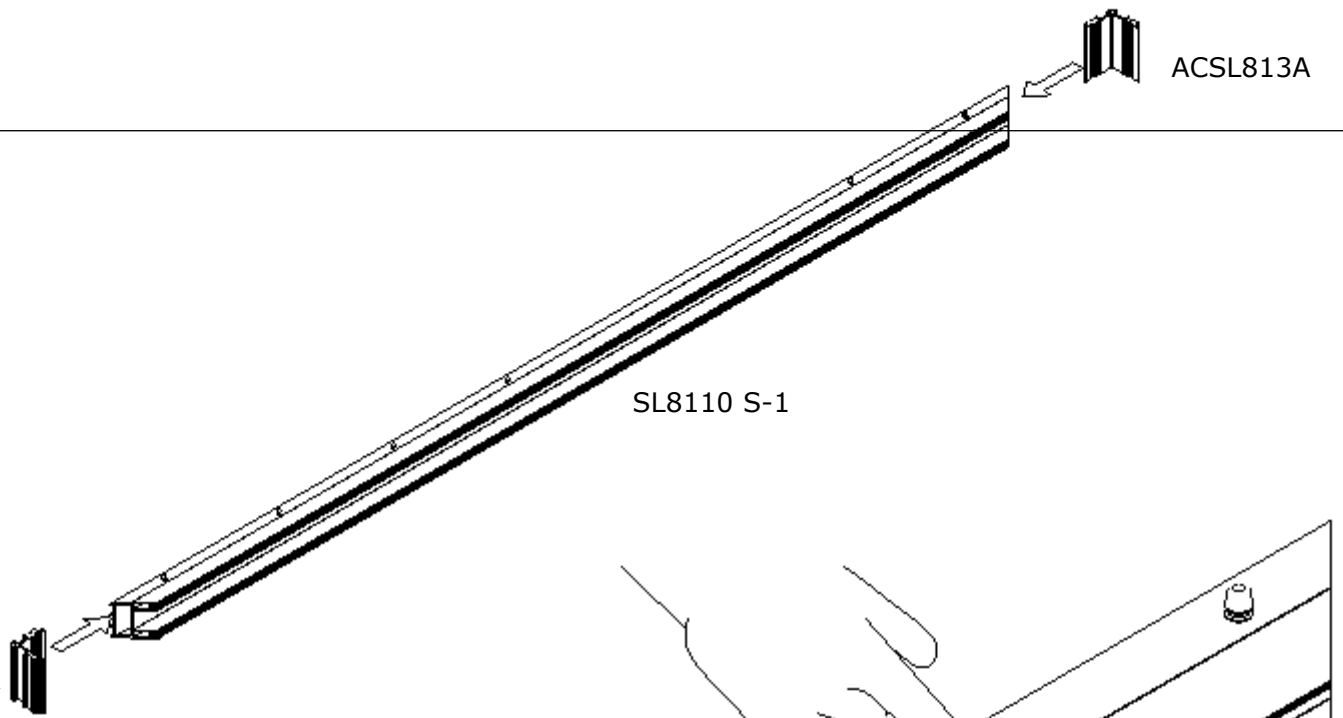

ACSL813A

SL8110 S-1

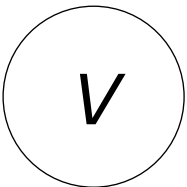
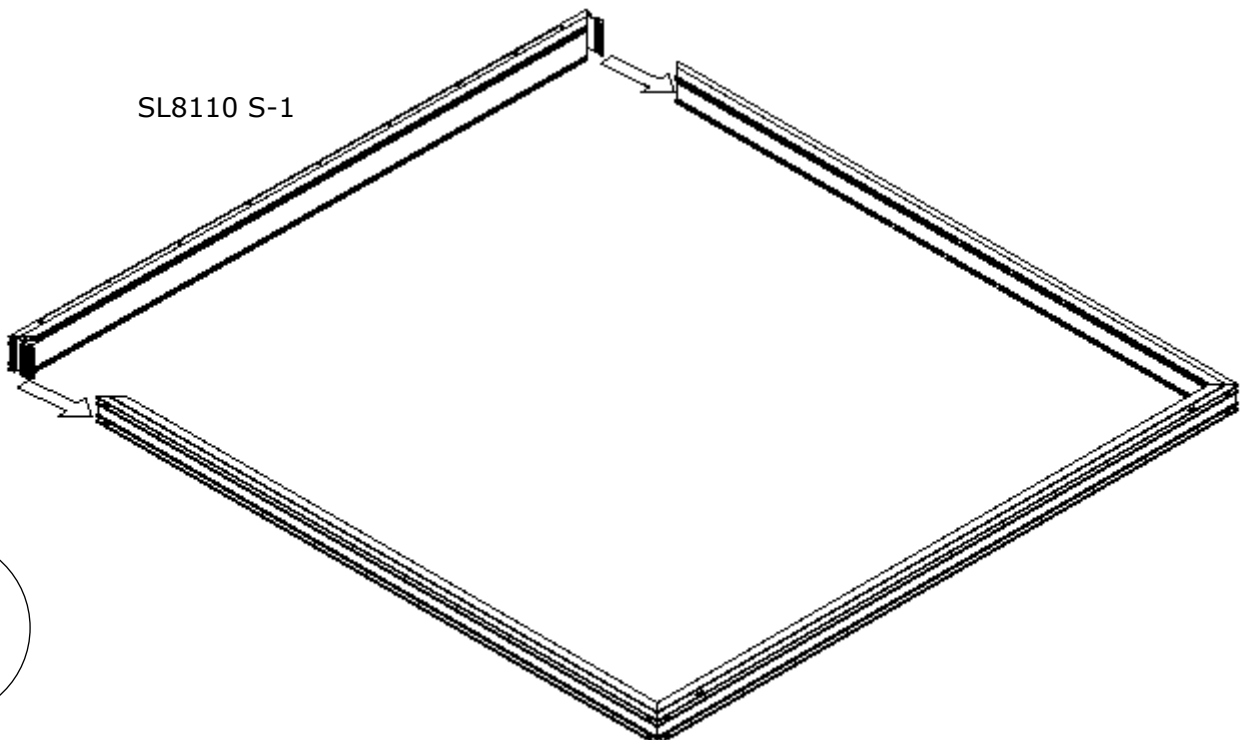

Plan: 15 LU59-5P-7016

Positions:

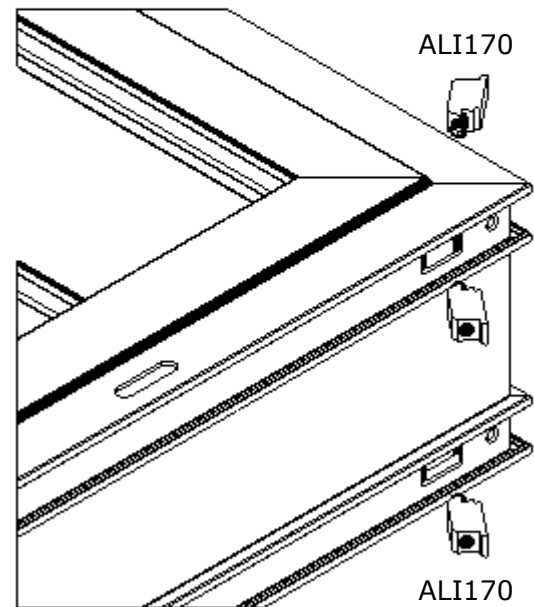
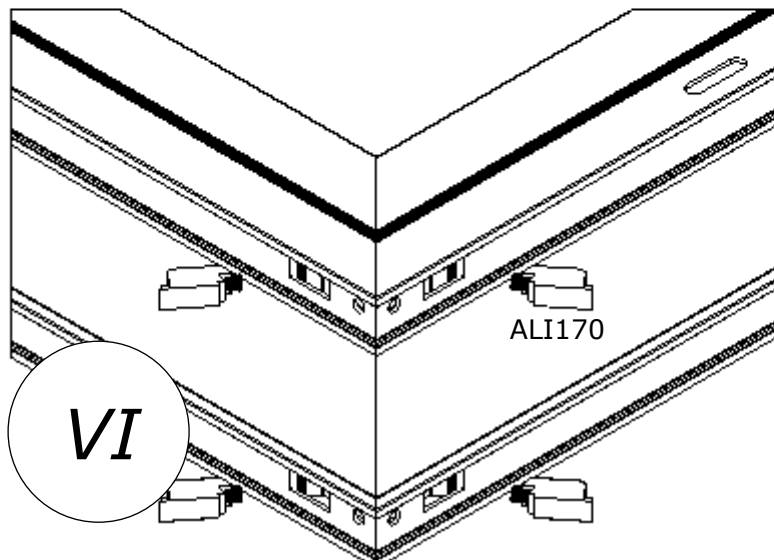
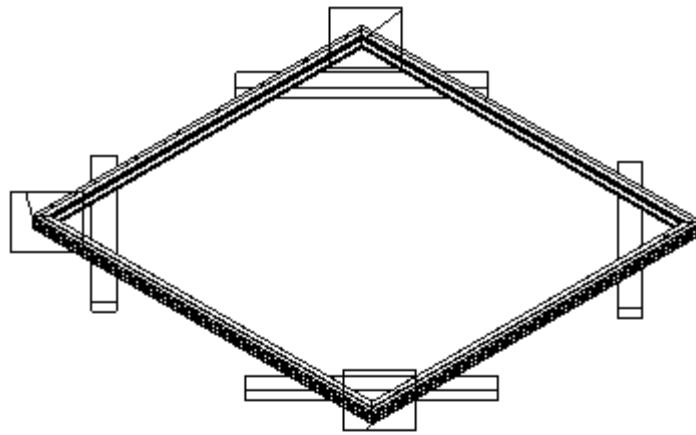
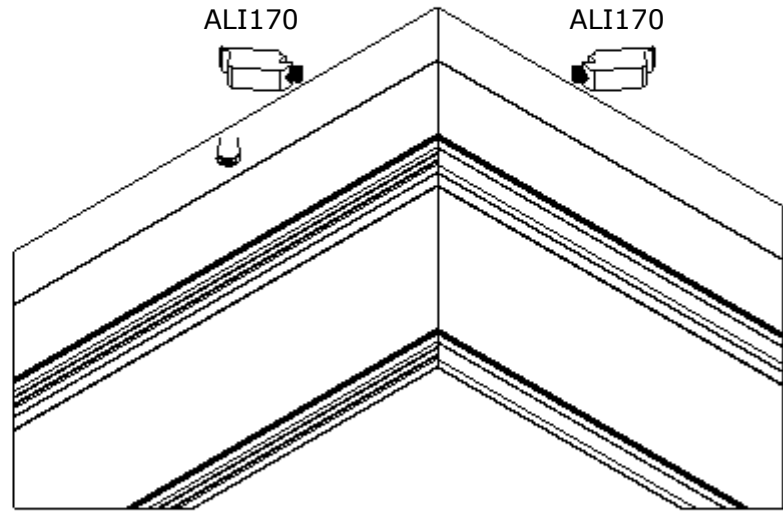
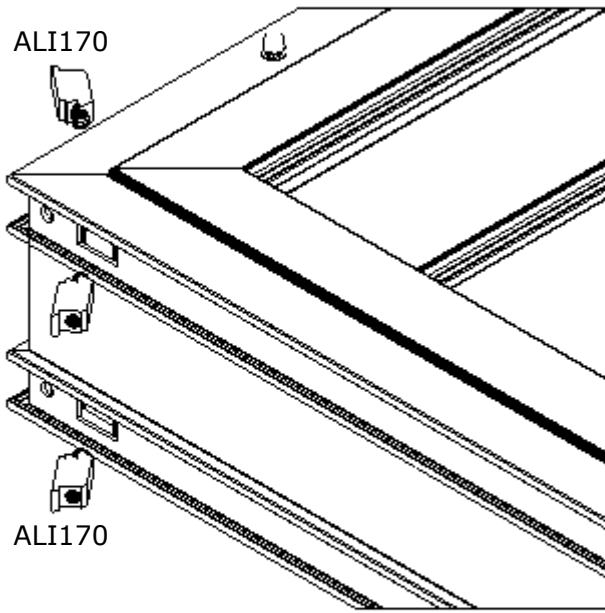

Plan: 15 LU59-5P-7016

Positions:

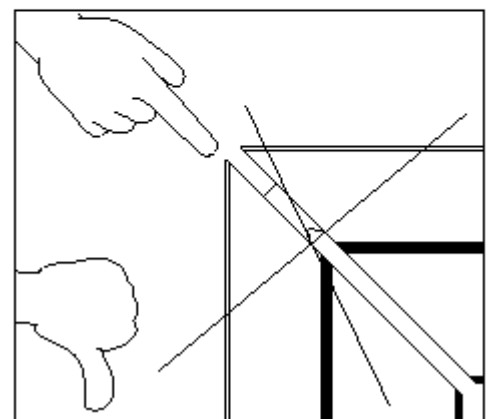
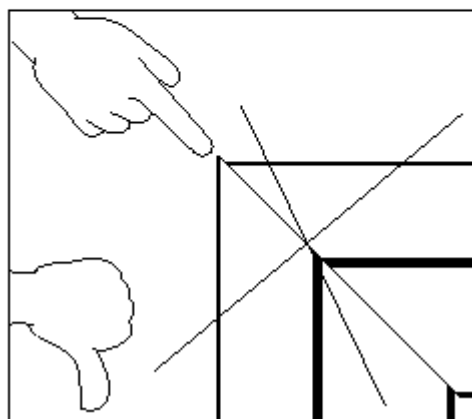
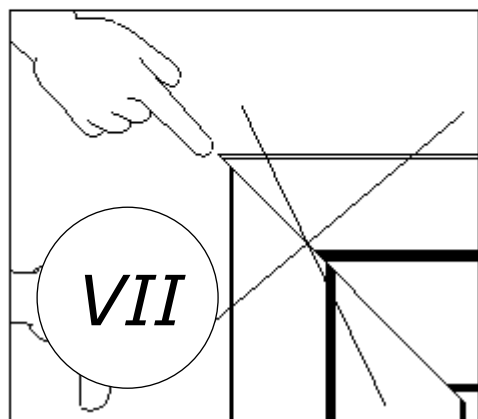
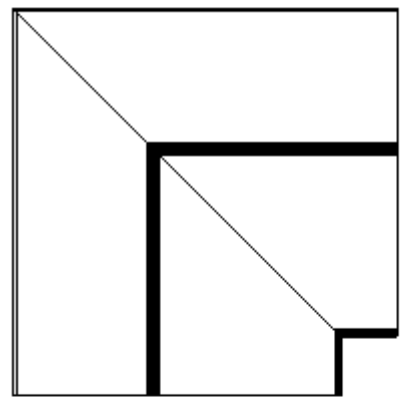
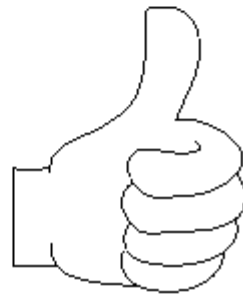
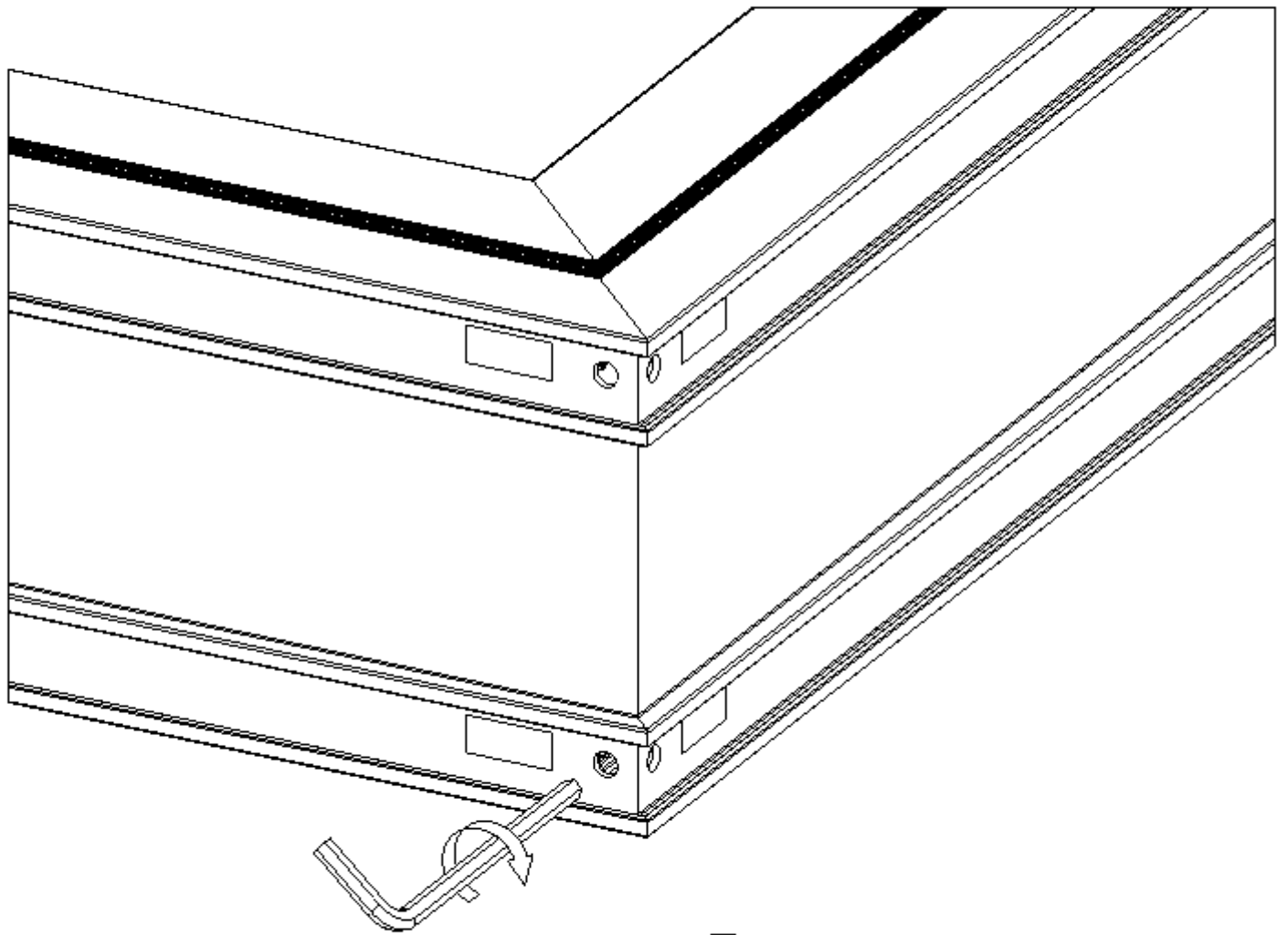

Plan:

Positions: TP, Sis



QKRPP3-5x50Zn

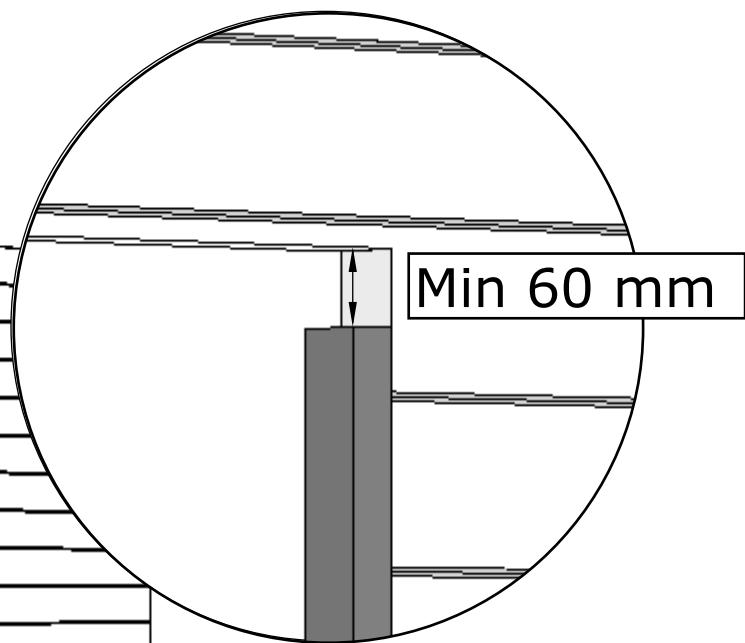
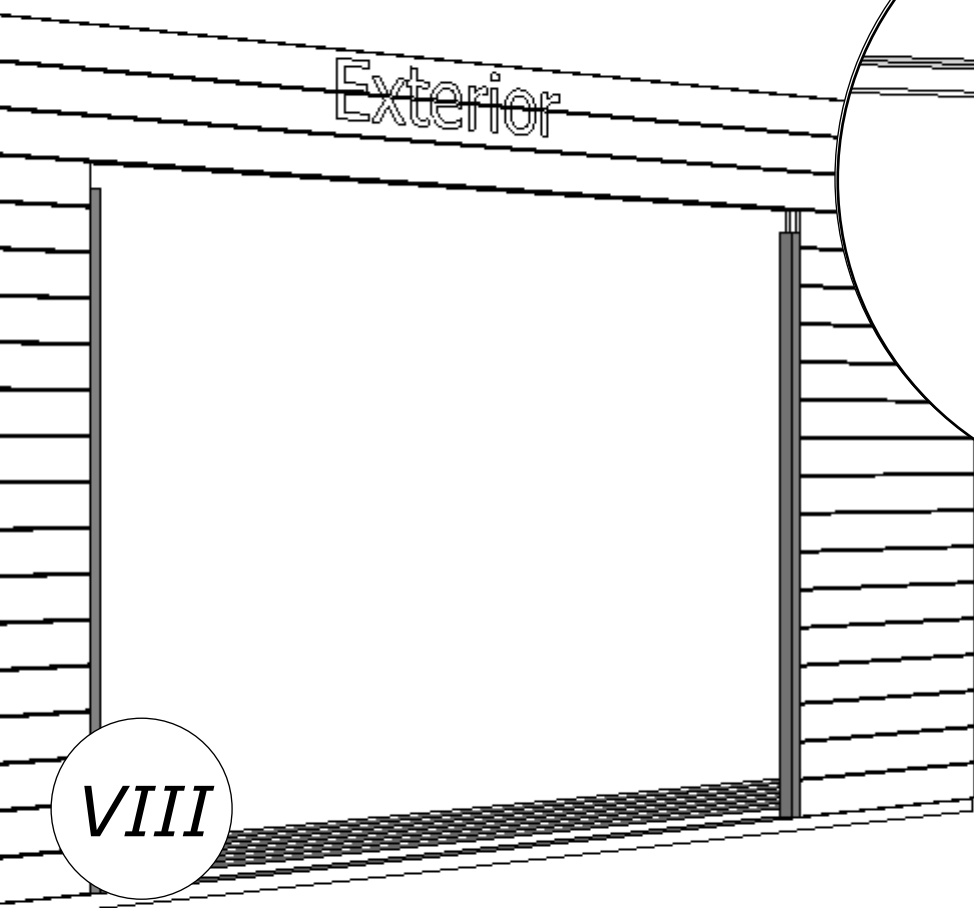
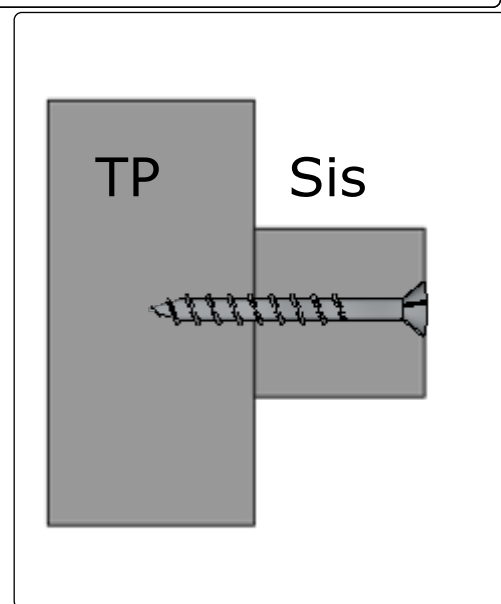
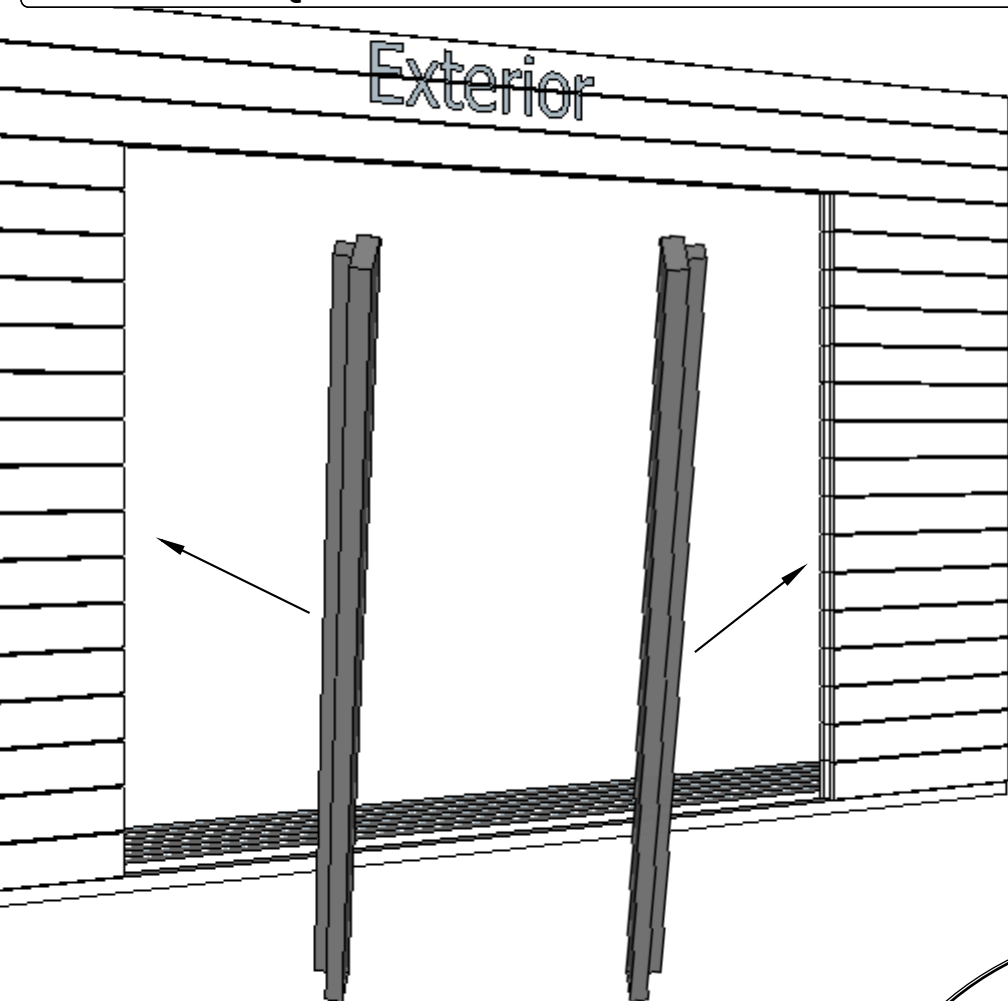

VIII

Plan: 15 LU59-5P-7016

Positions: Sla



QKRPP3-5x50Zn

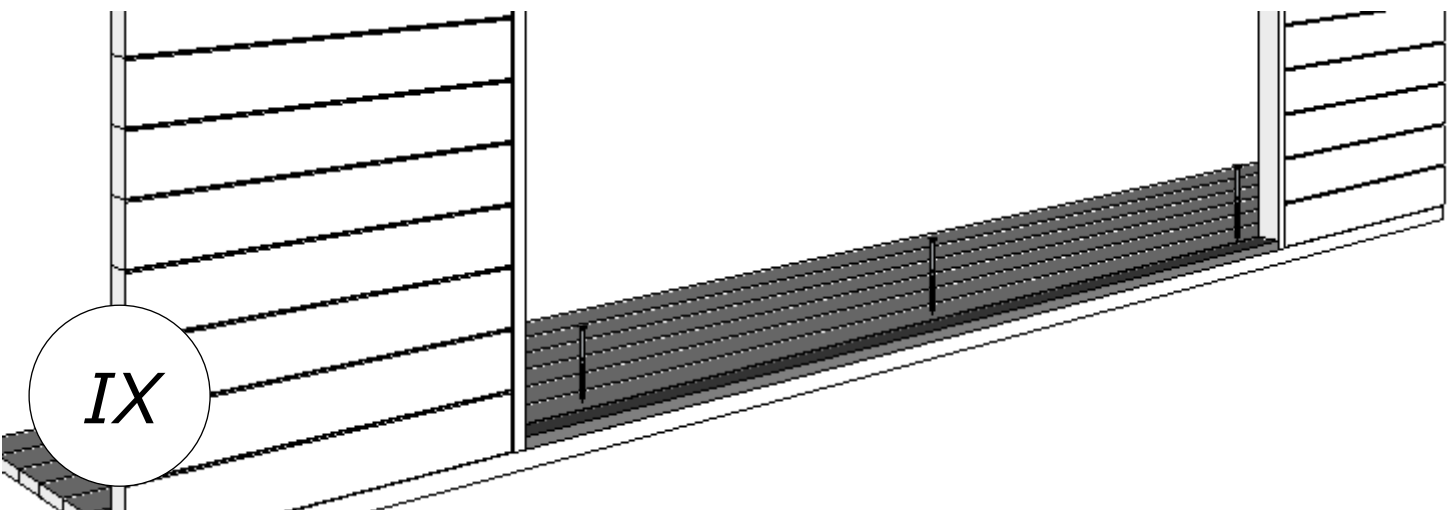
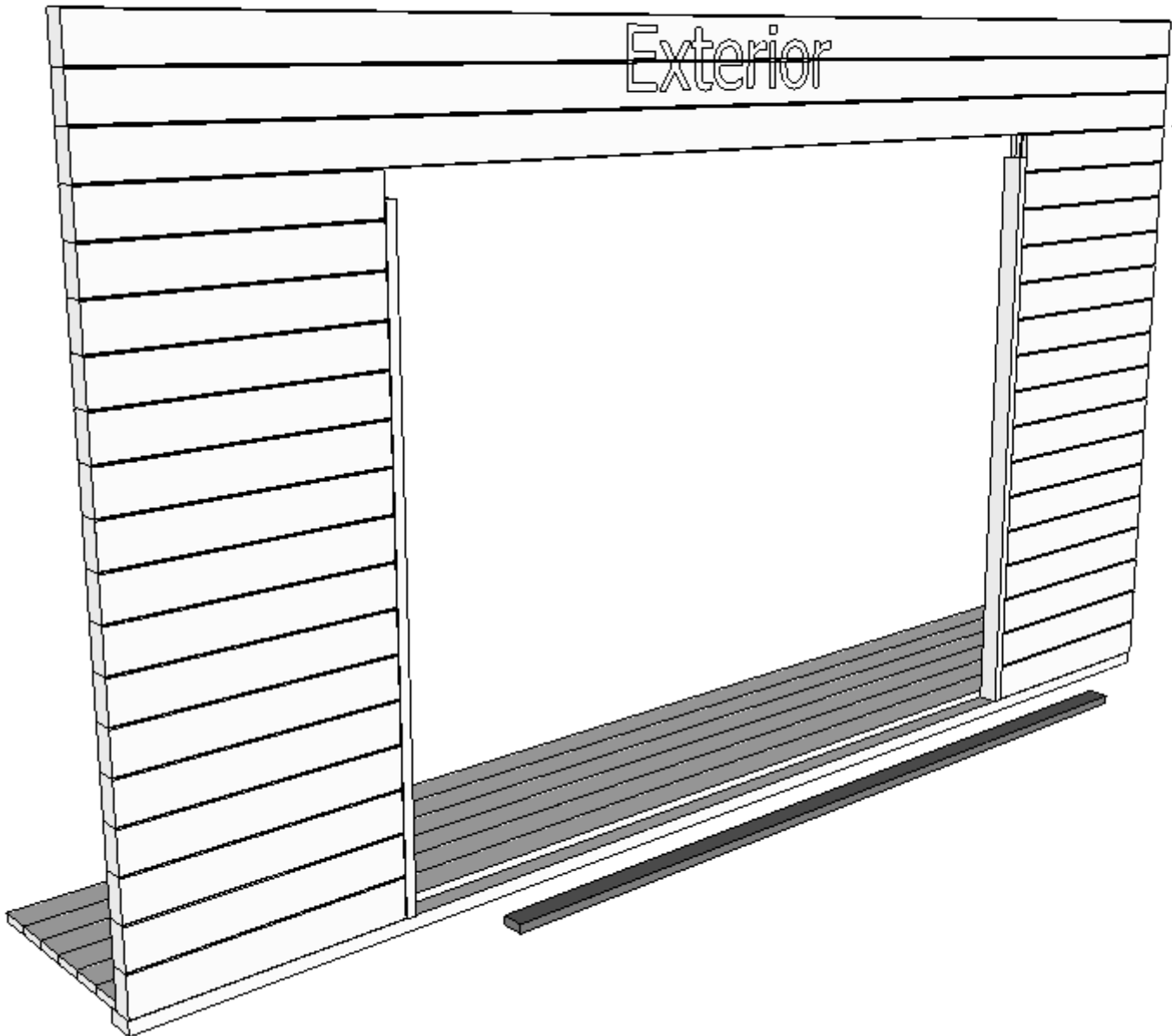

Plan: 15 LU59-5P-7016
Positions: QP40x30x2010MU

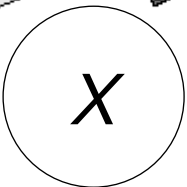
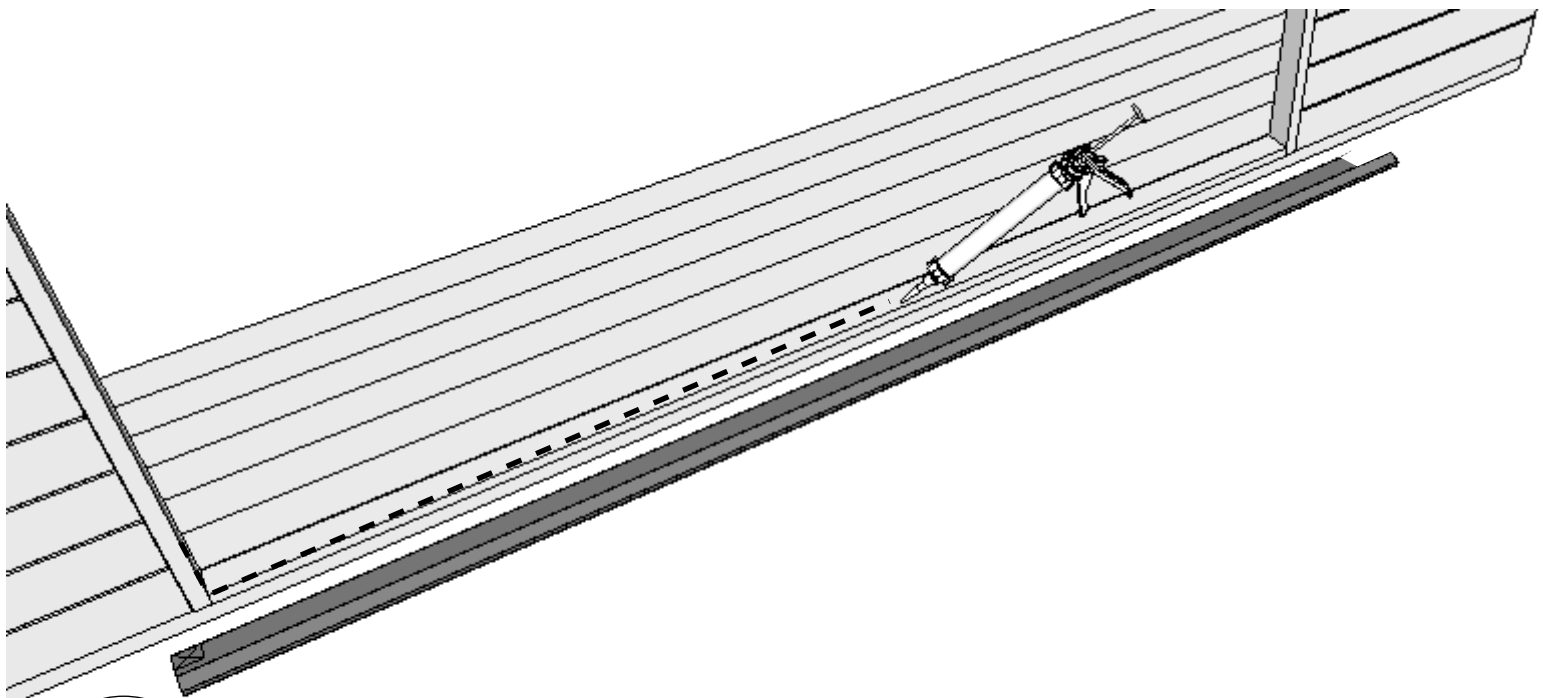
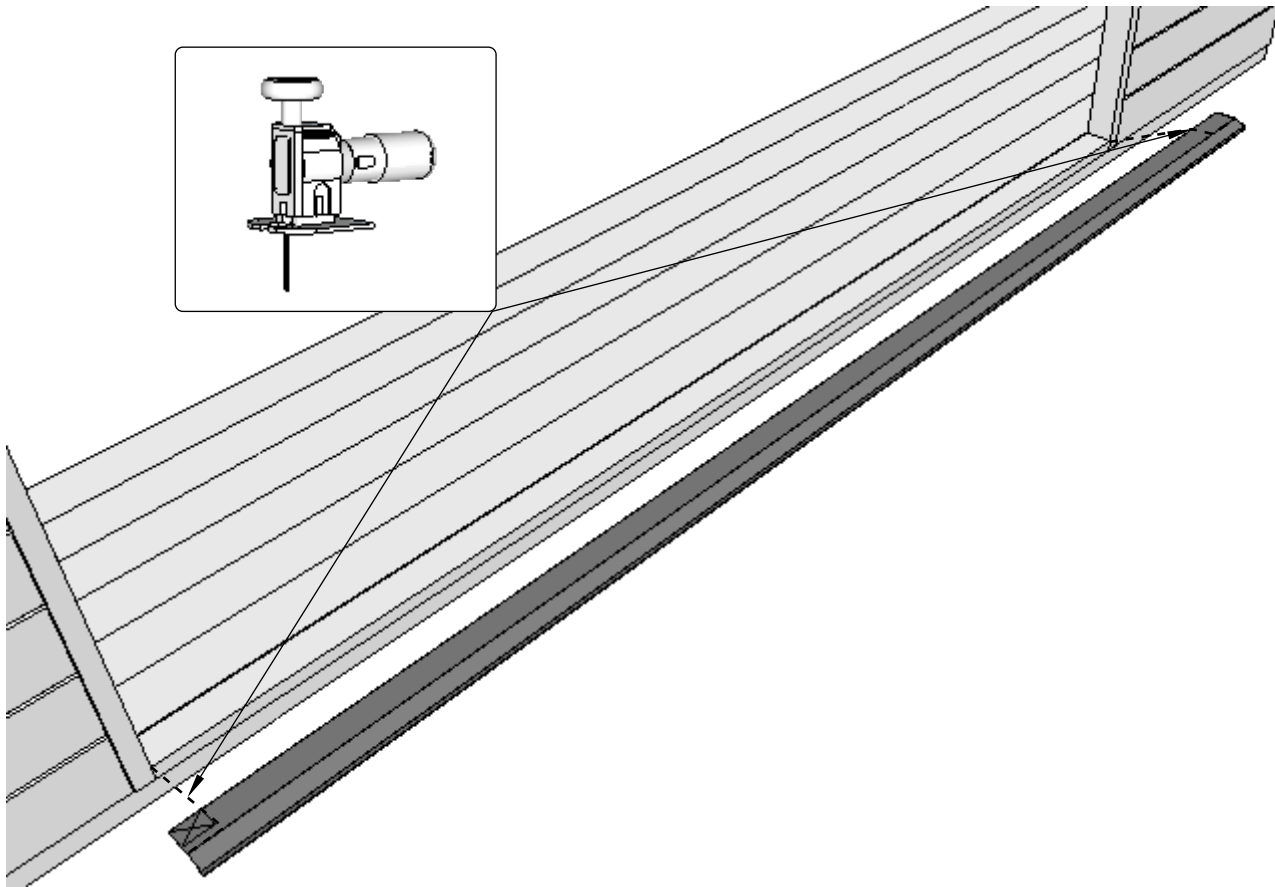
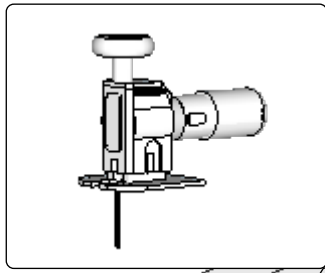

Plan: 15 LU59-5P-7016

Positions:

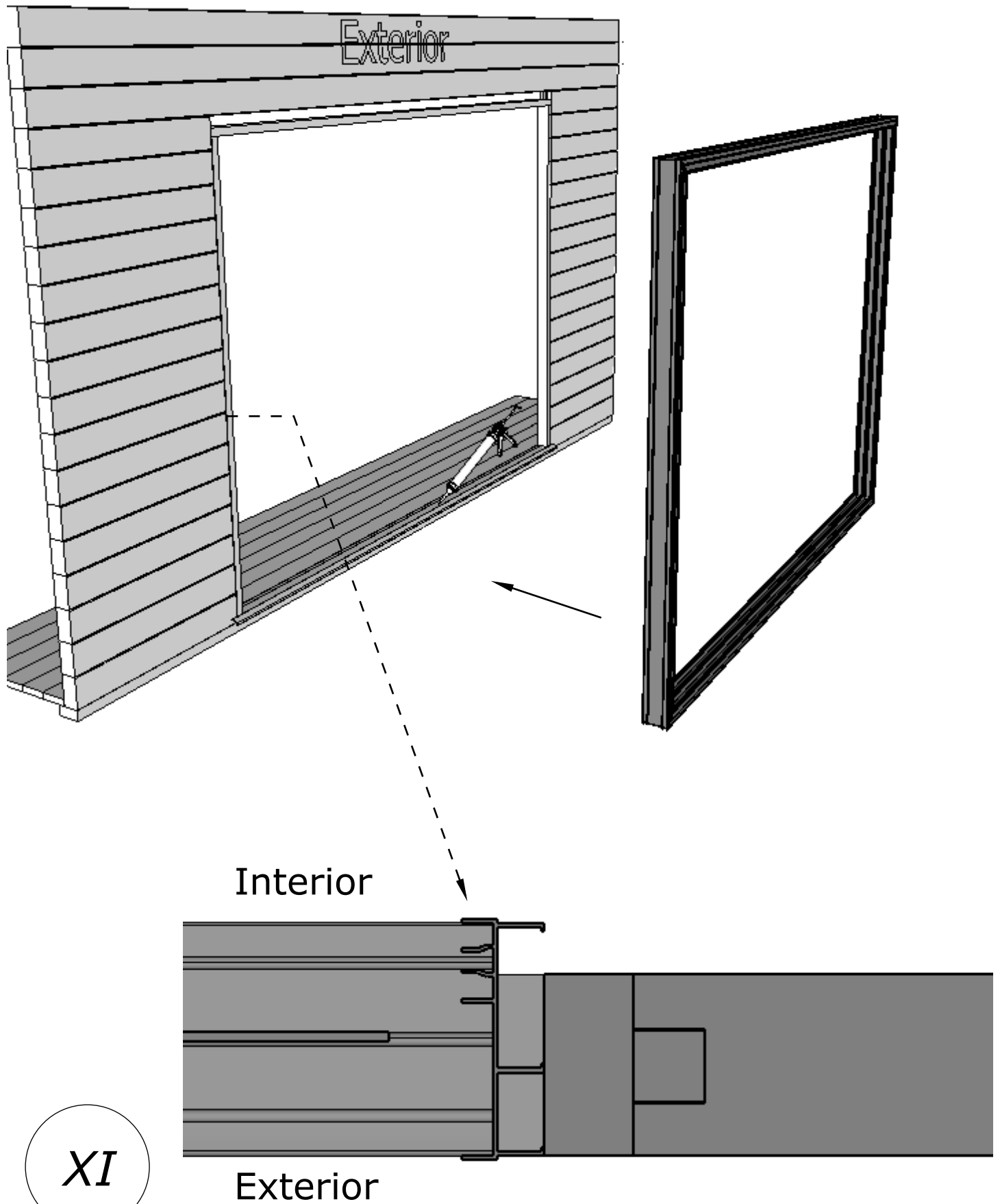

Plan: 15 LU59-5P-7016

Positions:

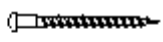

QKRYP5x60Zn

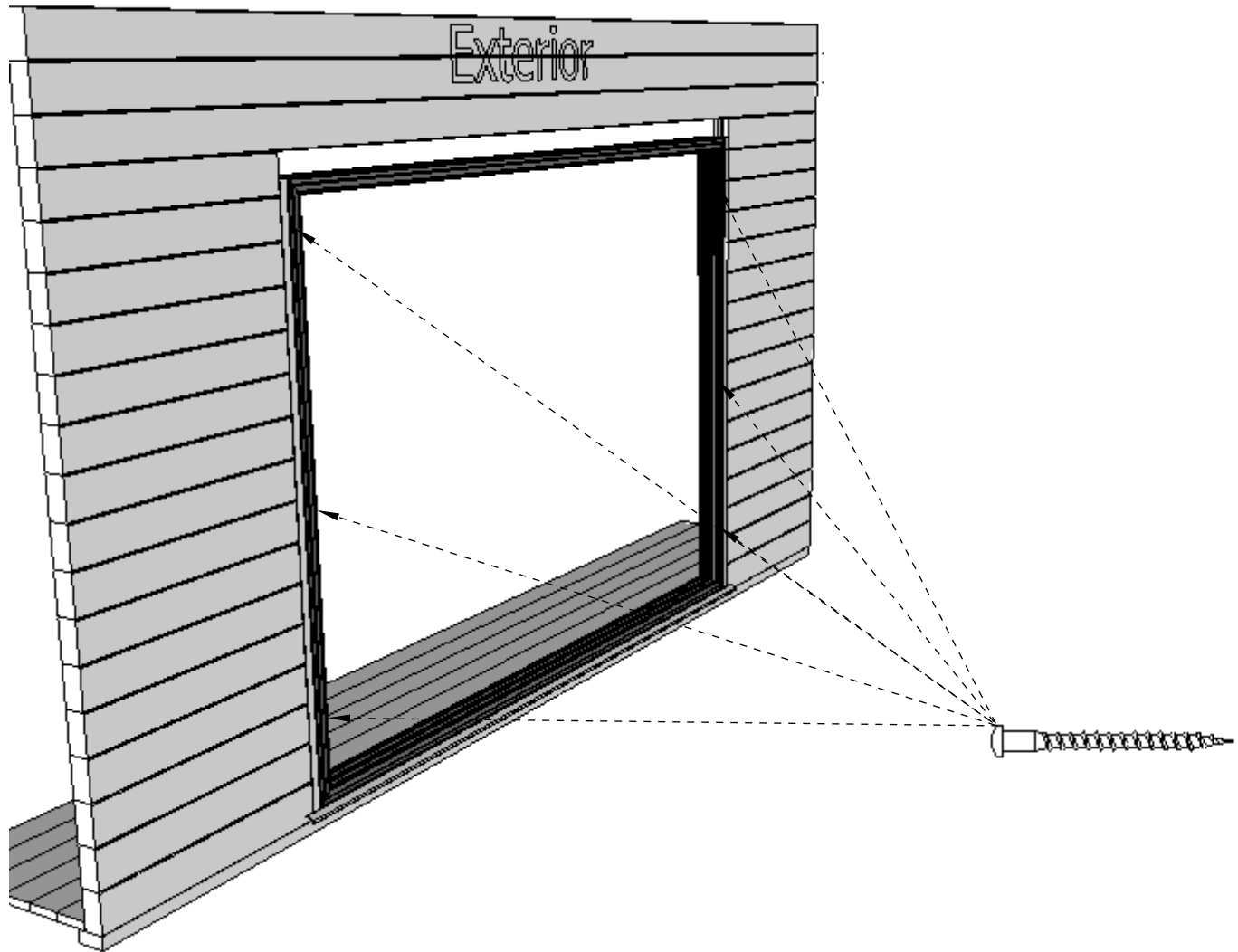

Interior

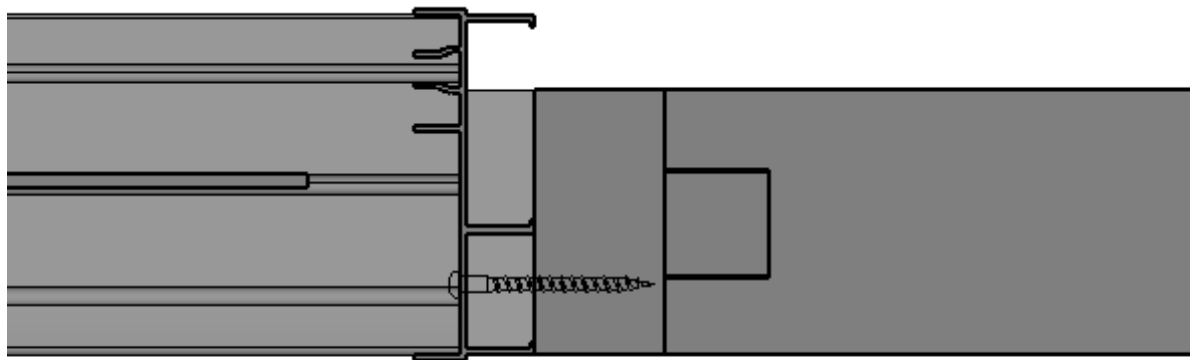

Exterior

XII

Plan: 15 LU59-5P-7016

Positions:

Sis

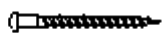

QKRYP5x60Zn

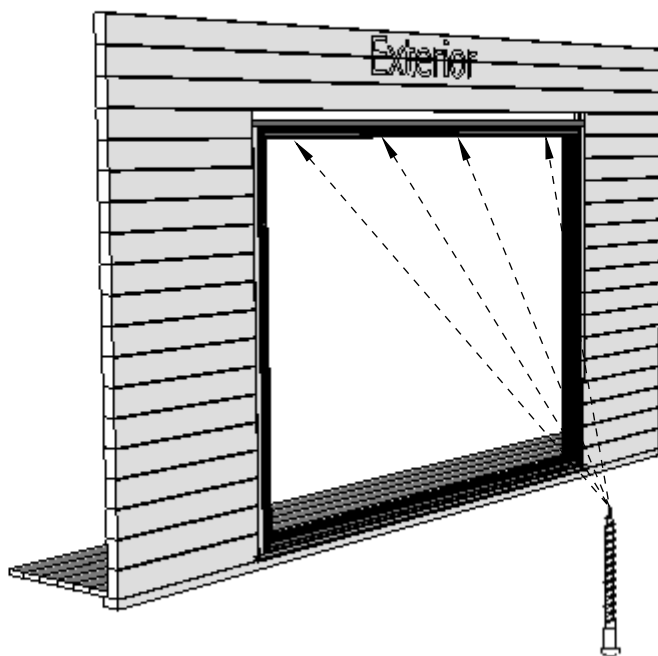
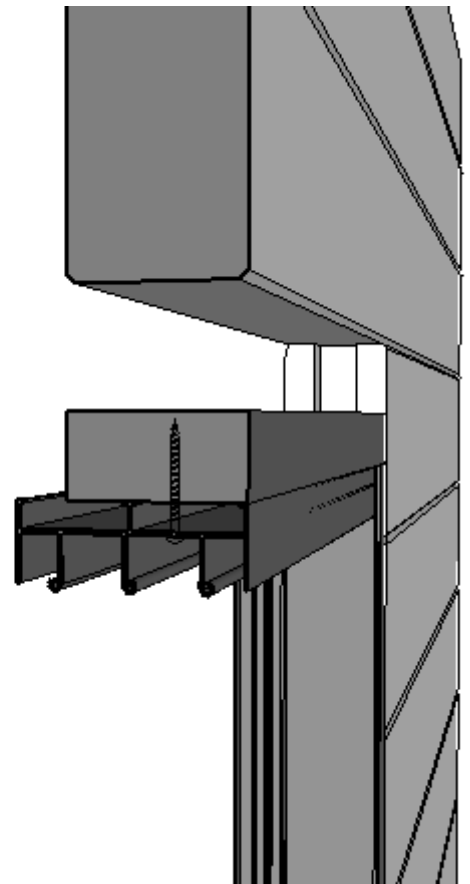
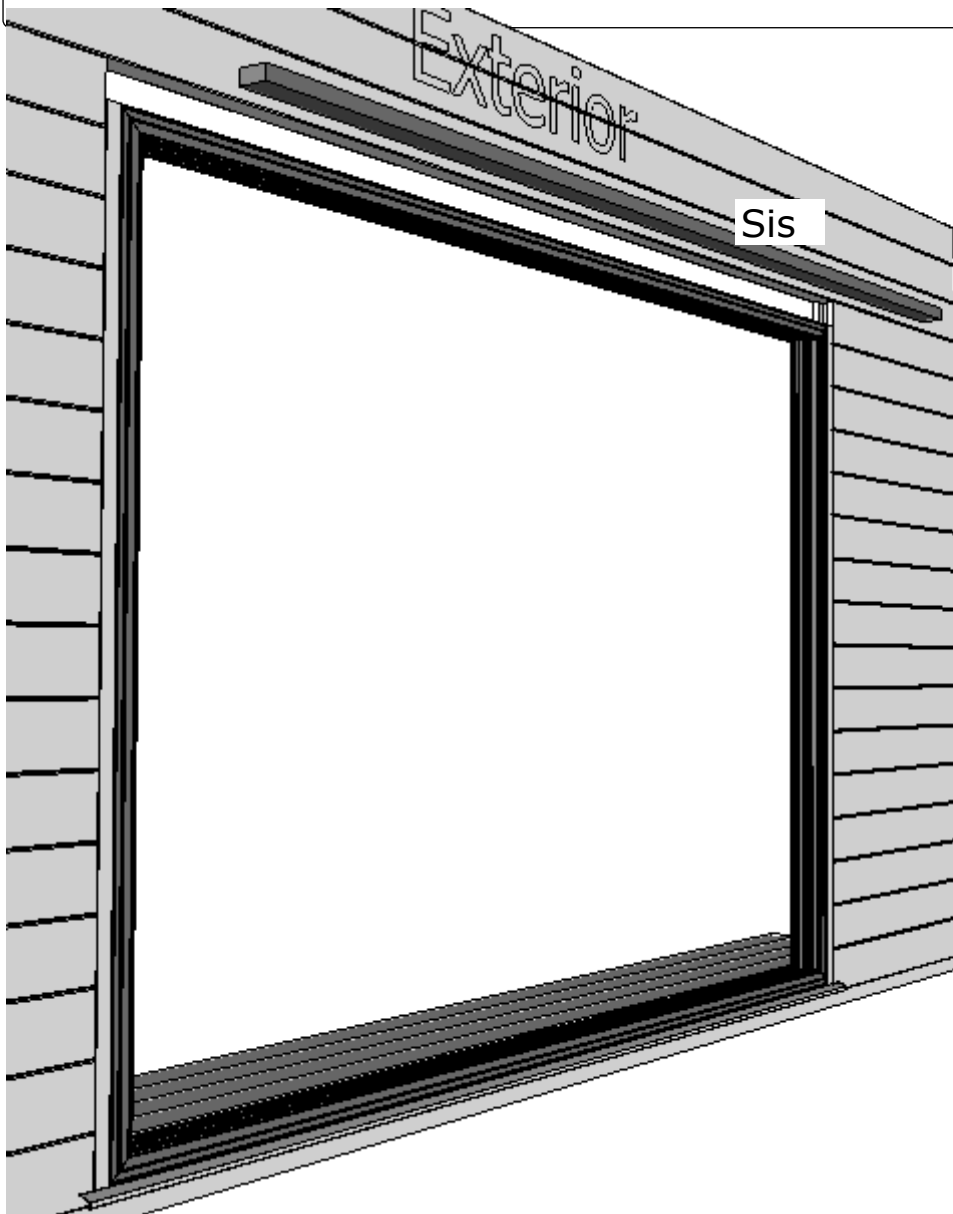

Plan: 15 LU59-5P-7016

Positions:



QKRYP5x60Zn



QG2

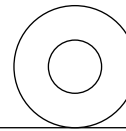

QSE3x8_5

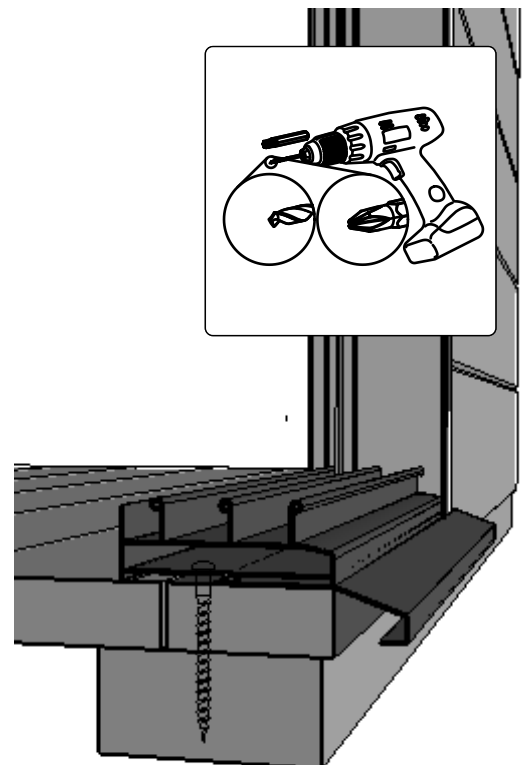
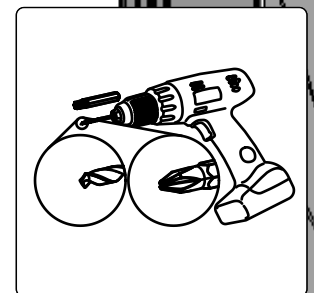
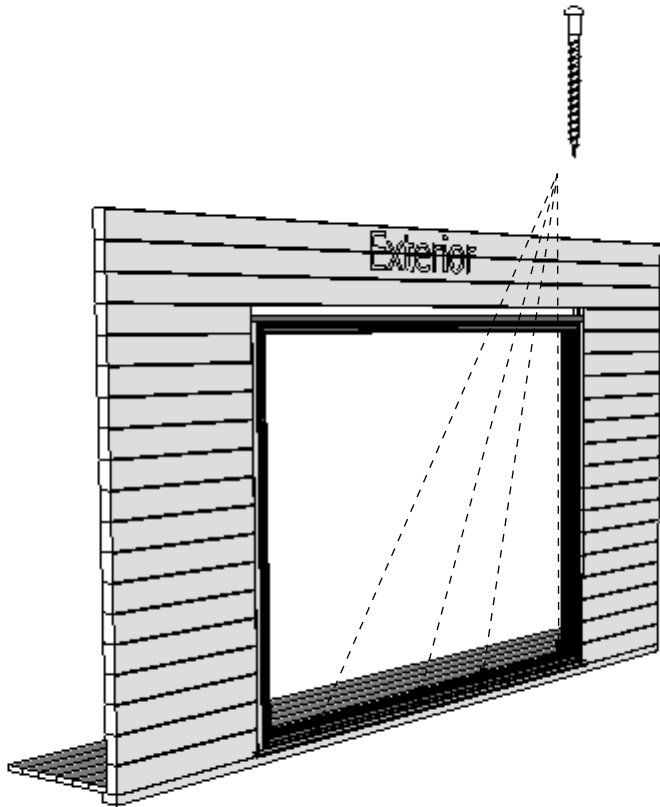

XIV

Plan: 15 LU59-5P-7016
Positions: QT140-1

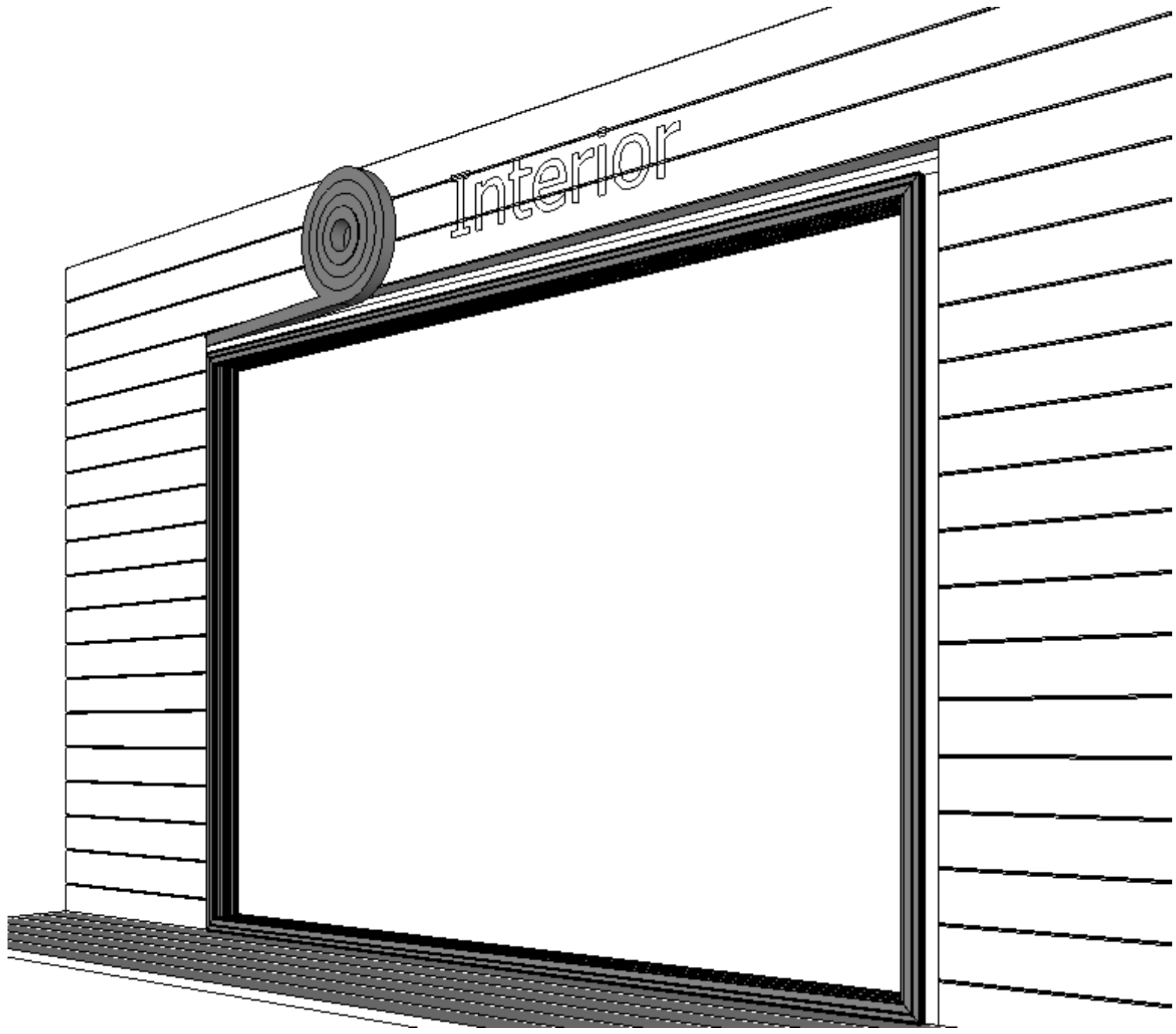

Plan: 15 LU59-5P-7016

Positions: COB



QKRPP3-5x50Zn

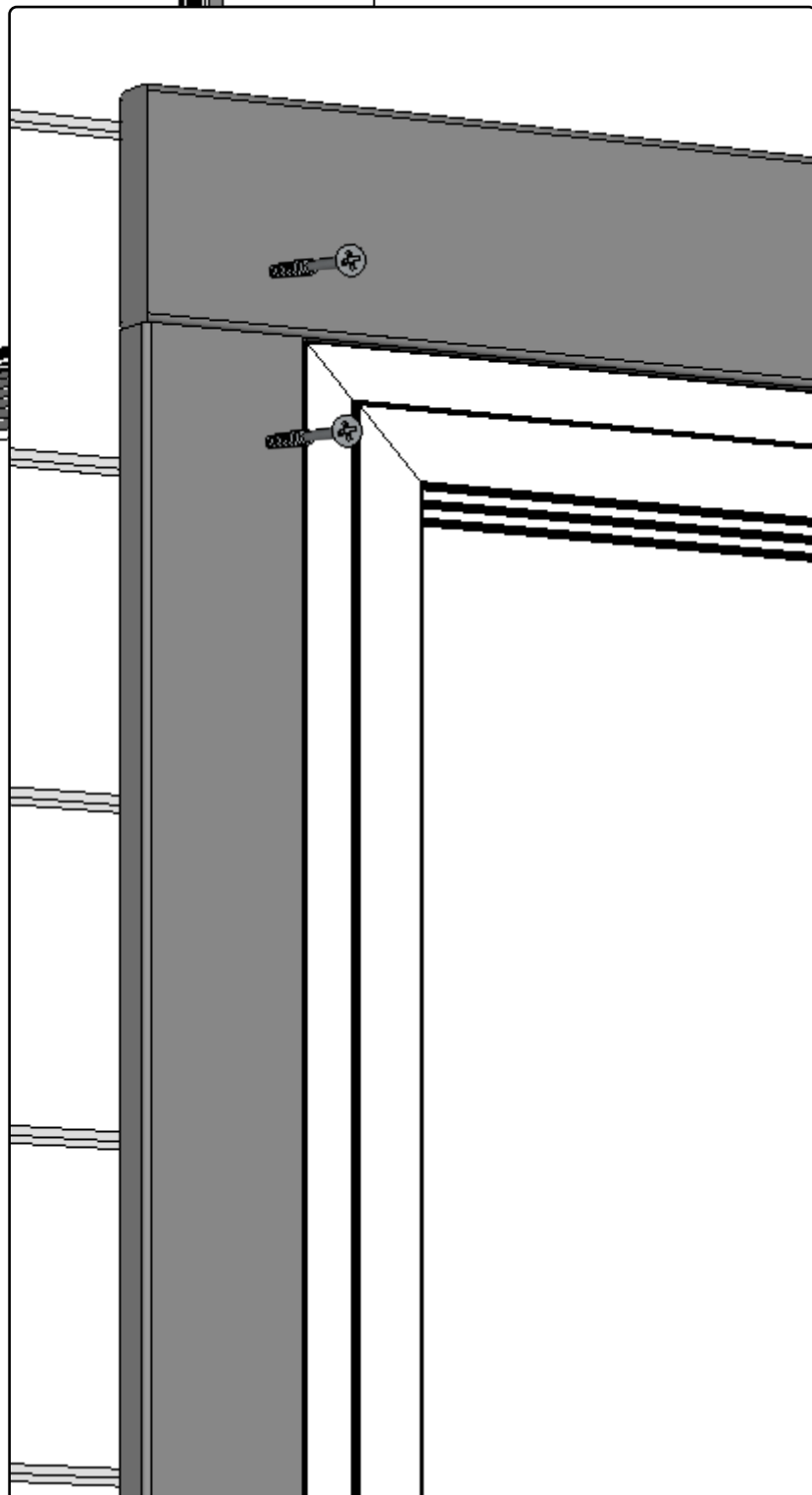
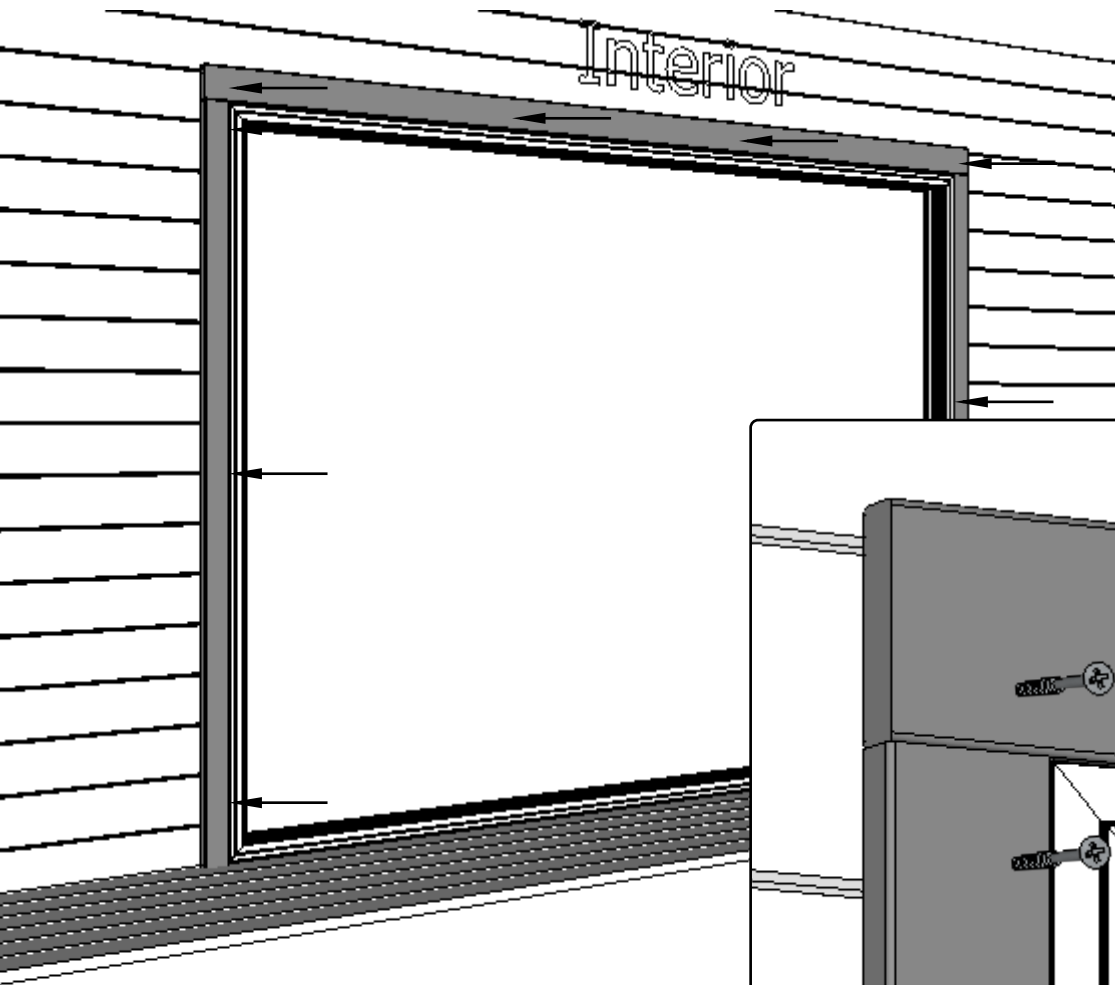

Plan: 15 LU59-5P-7016

Positions:

Exterior

3

2

Wind protective tape

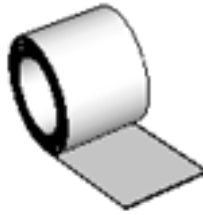

Not included

1

1

XVII

Plan: 15 LU59-5P-7016

Positions: COB



QKRPP3-5x50Zn

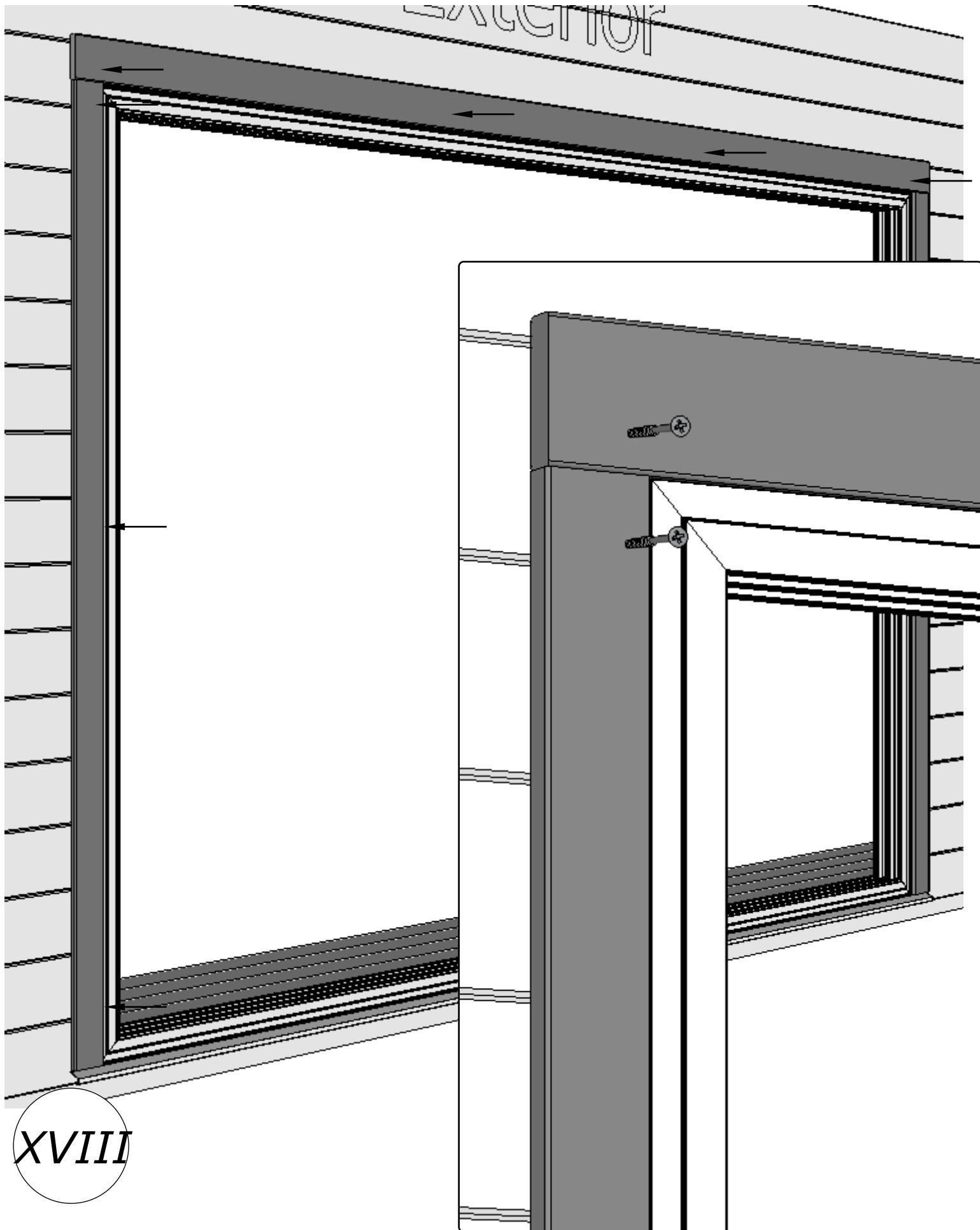

XVIII

Plan: 15 LU59-5P-7016

Positions: COB



QKRPP3-5x50Zn

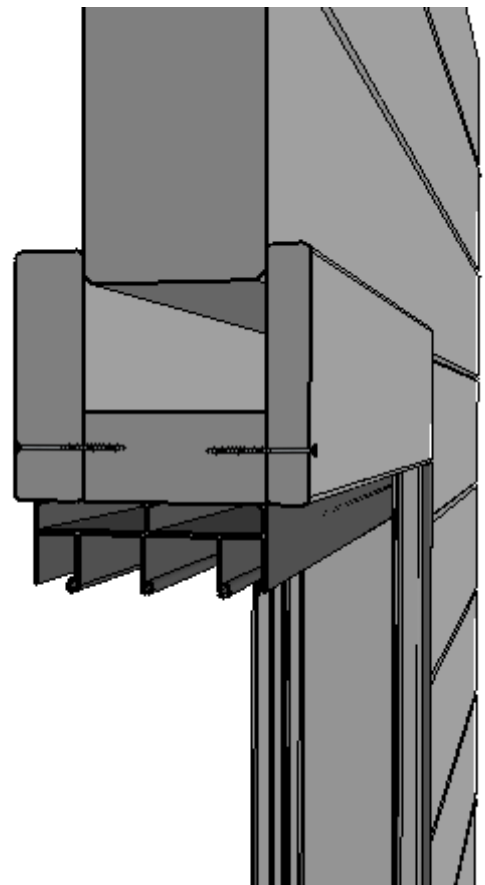
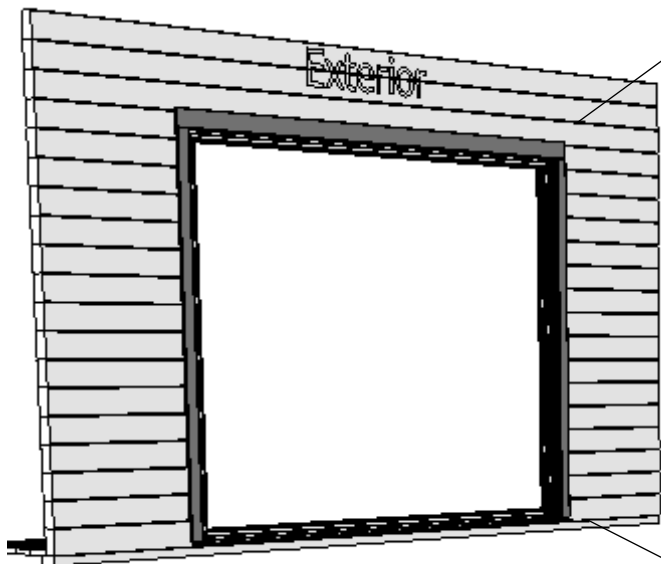

Interior

Exterior

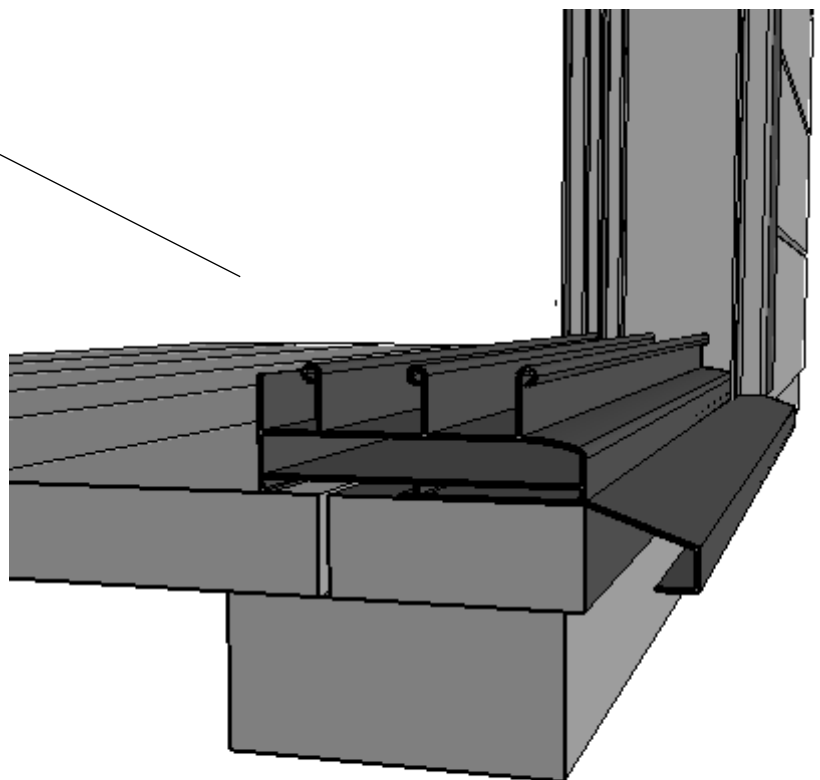

Plan: 15 LU59-5P-7016

Positions:

COB2 - COB8



QKRPP3-5x50Zn

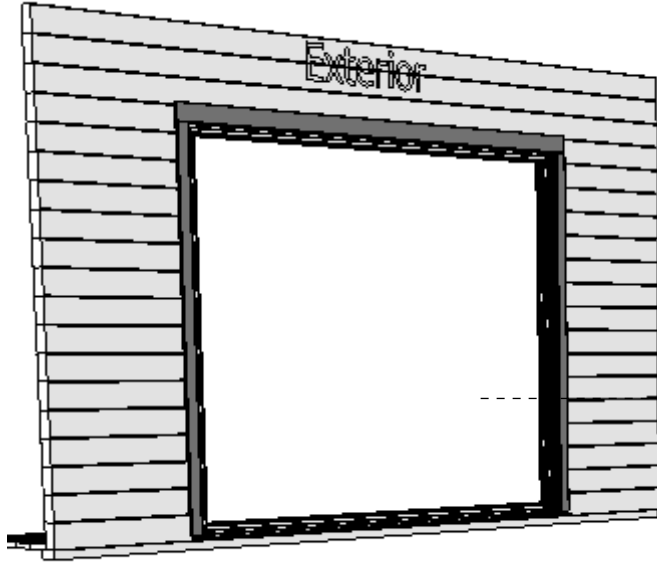

Interior

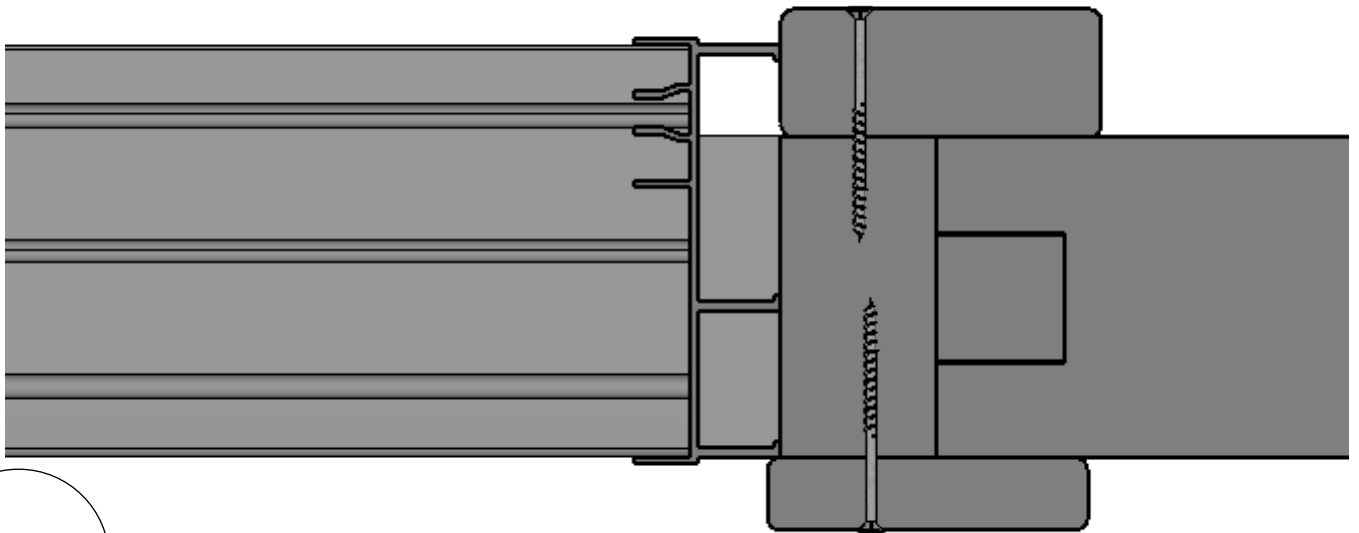

XX

Exterior

Plan: 15 LU59-5P-7016

Positions:

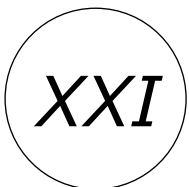
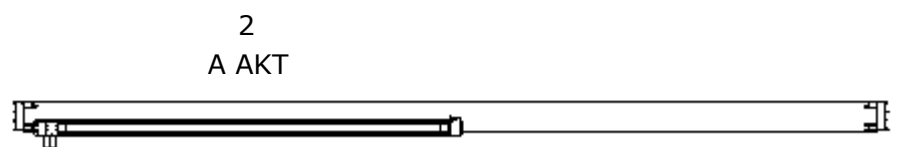
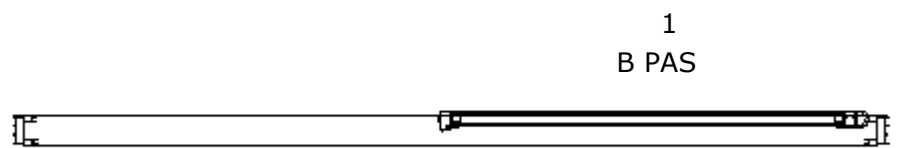
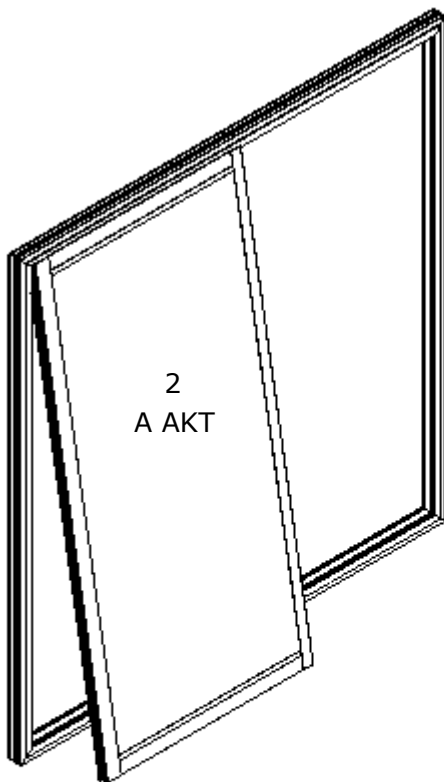
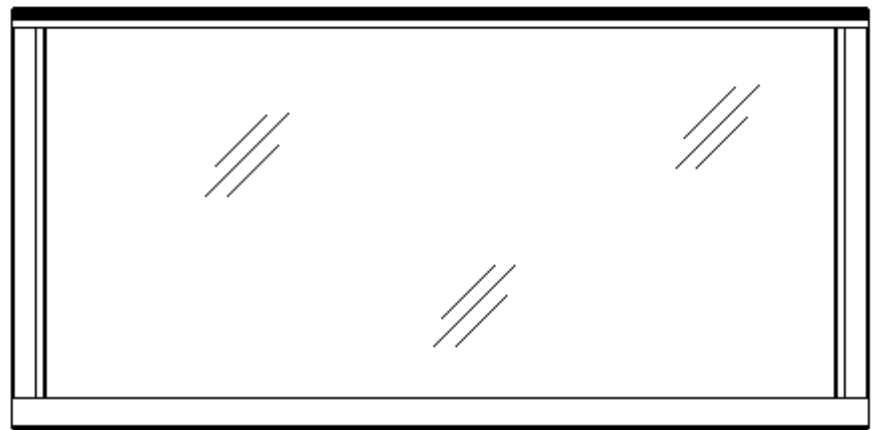
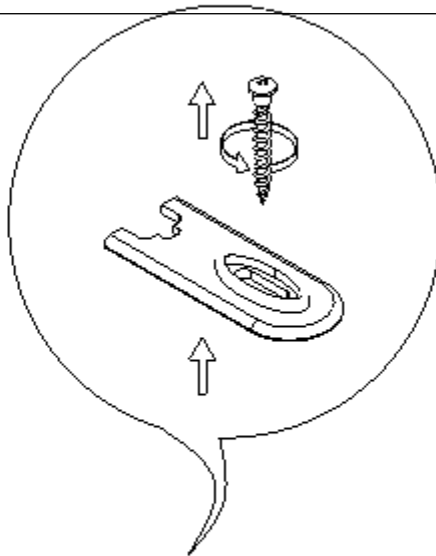
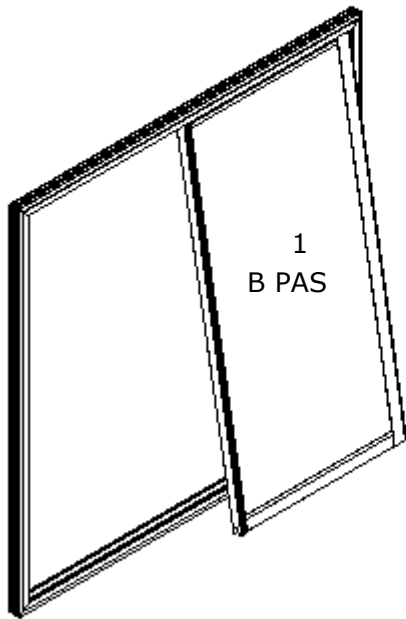

Plan: 15 LU59-5P-7016

Positions:

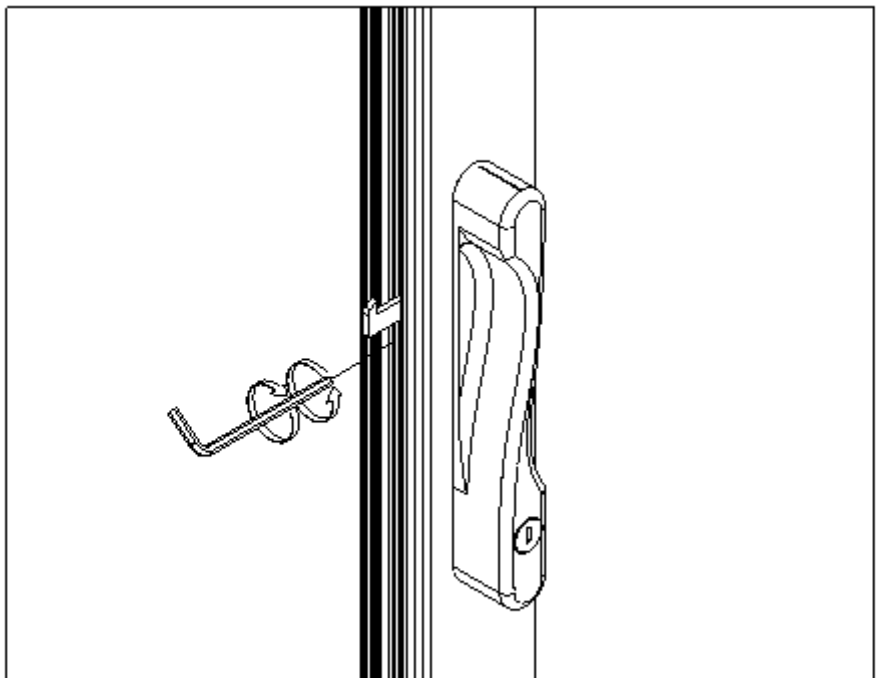
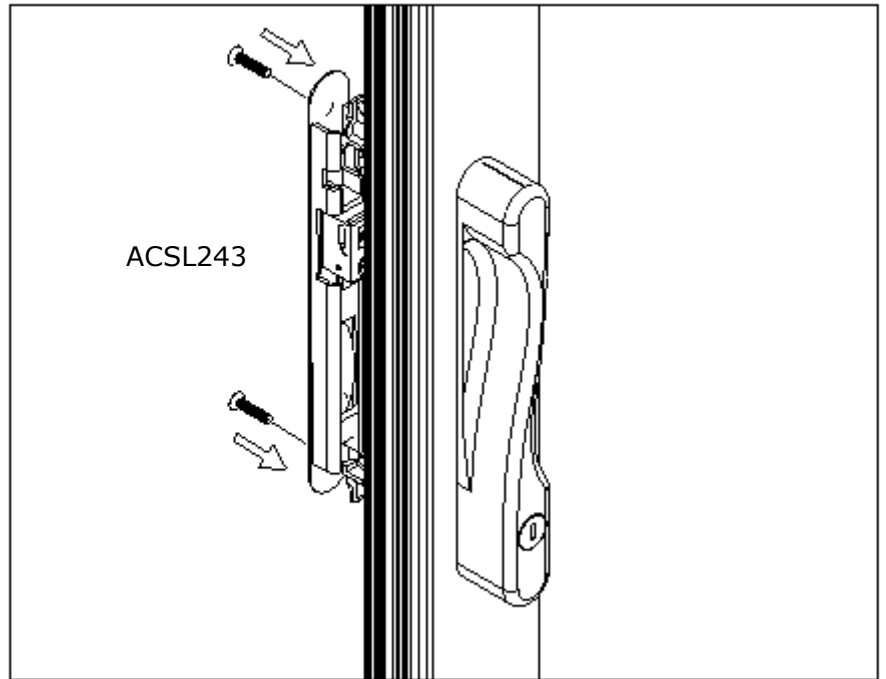
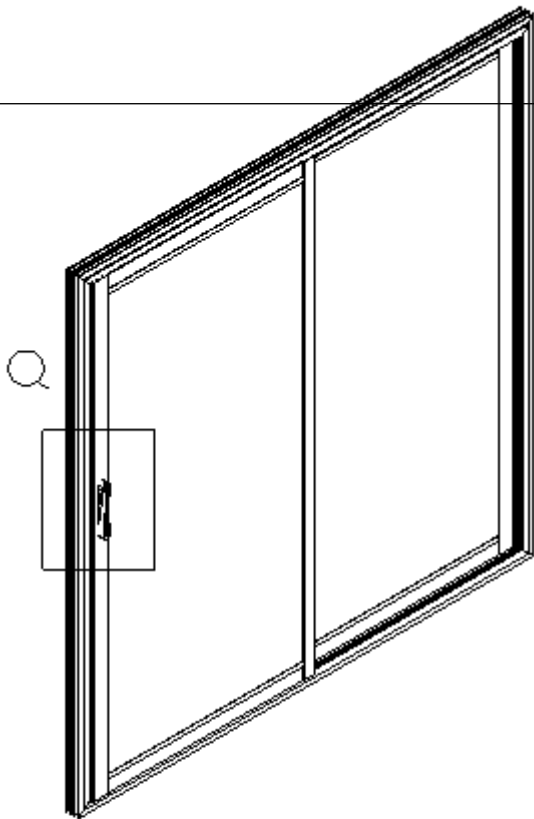

Plan: 15 LU59-5P-7016

Positions:

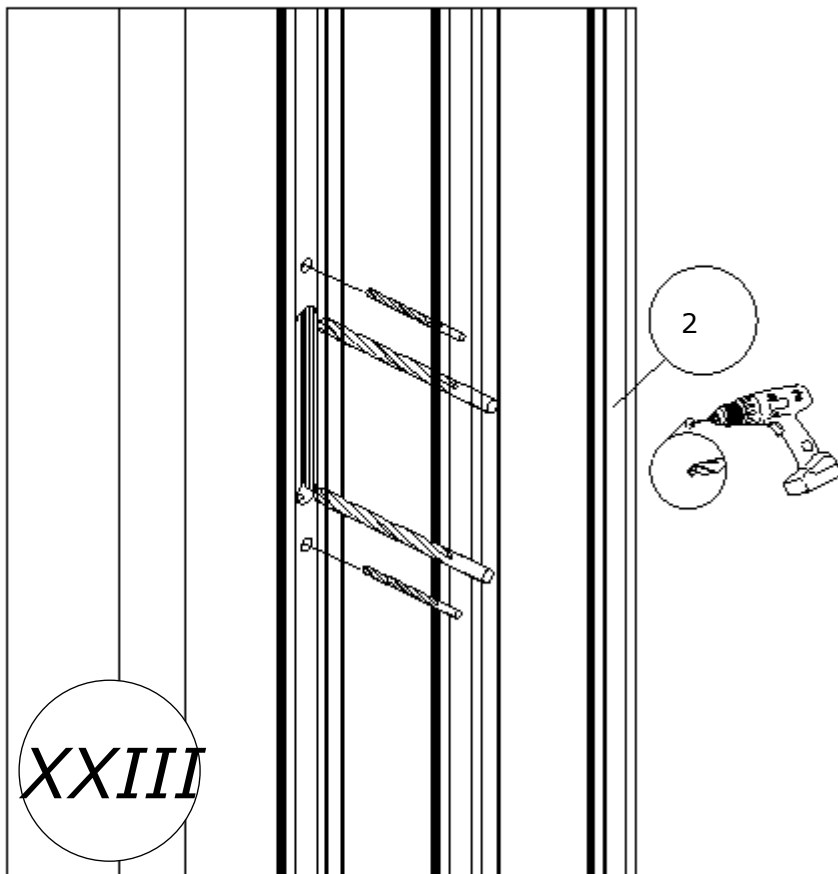
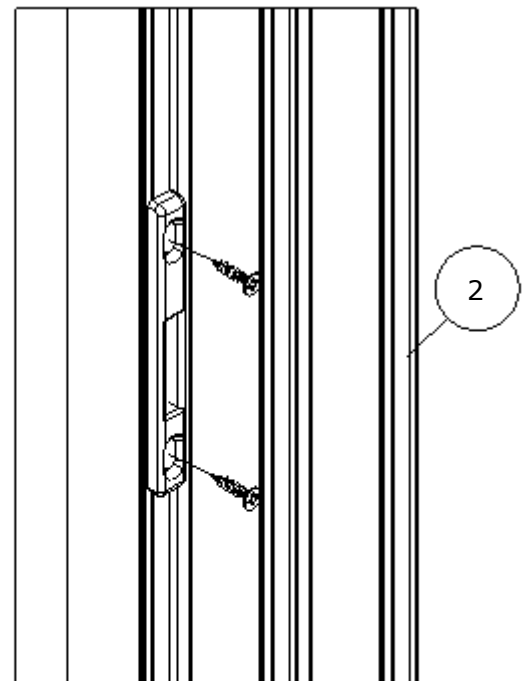
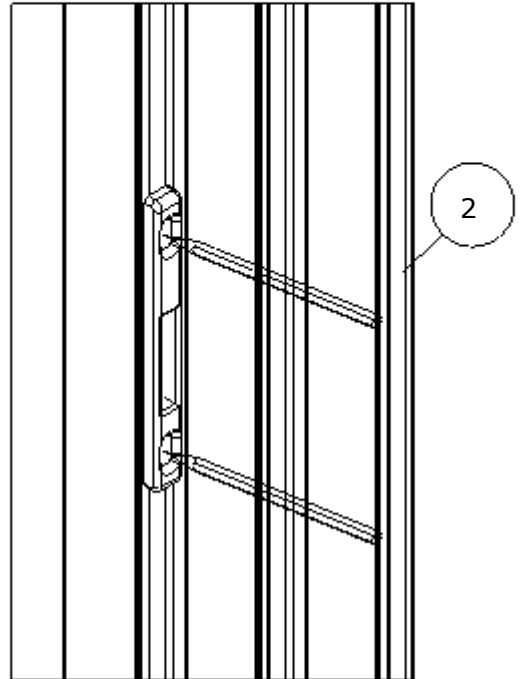
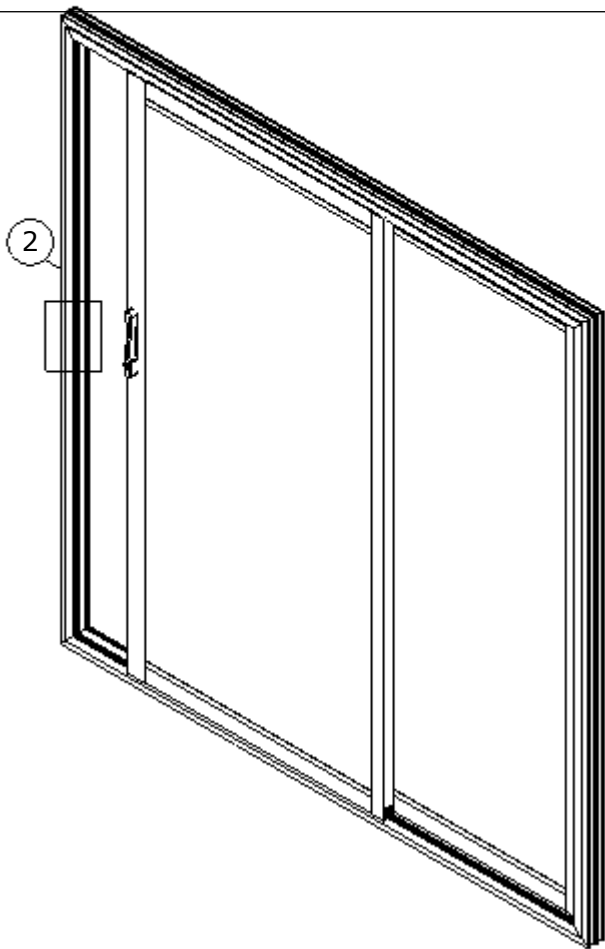

XXIII

Plan: 15 LU59-5P-7016

Positions:

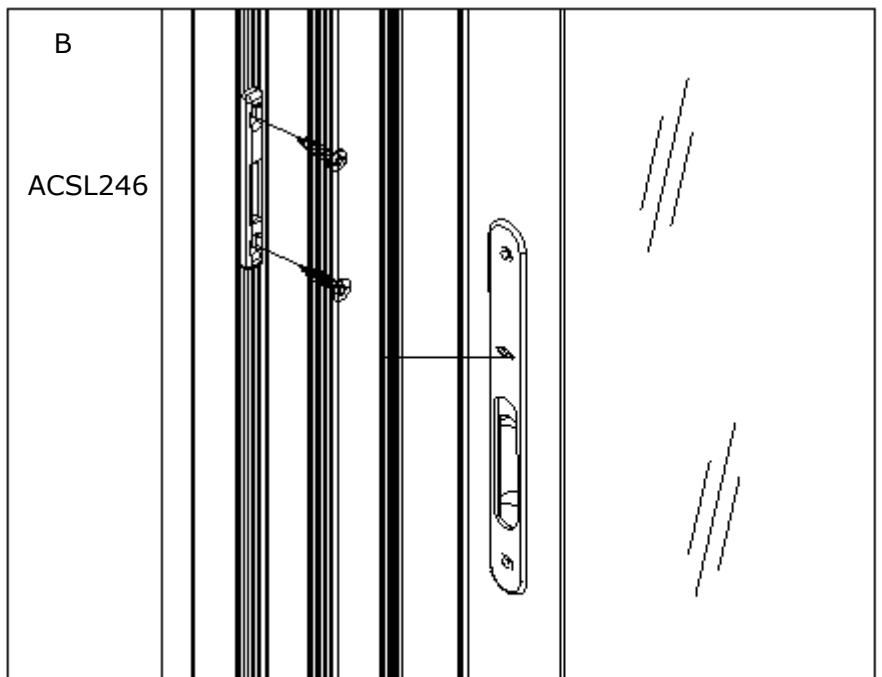
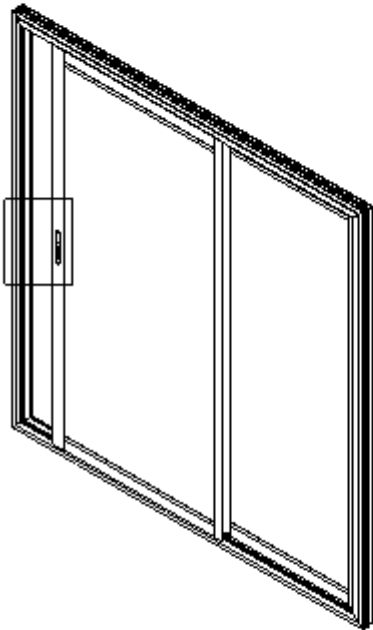
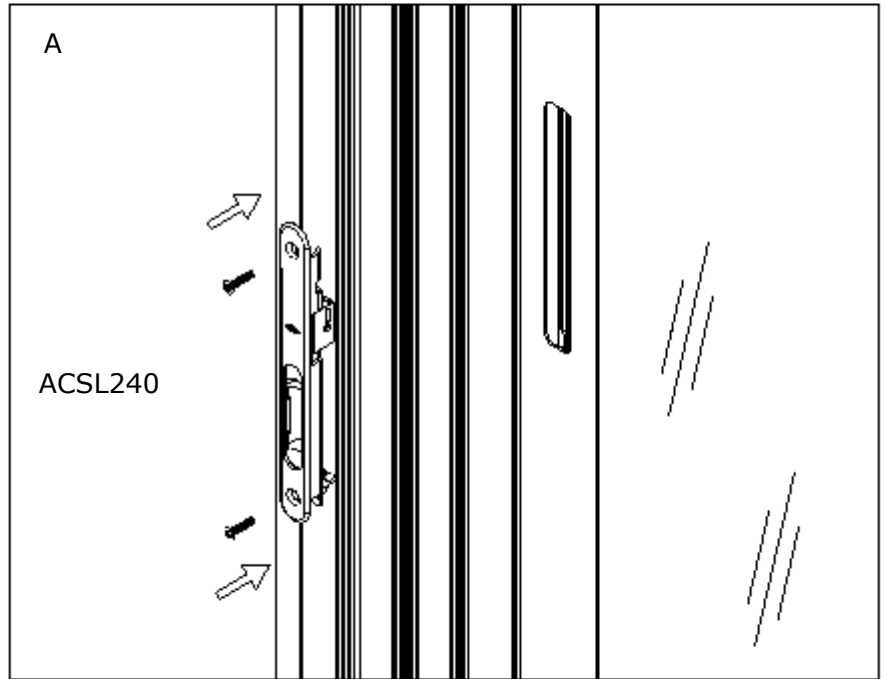
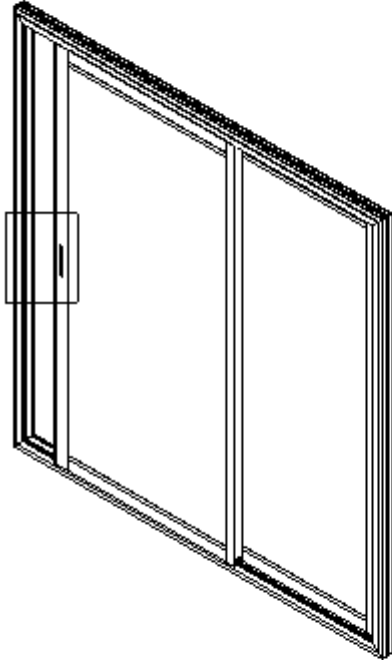

Plan: 15 LU59-5P-7016

Positions:

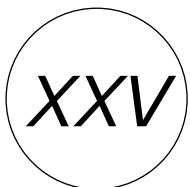
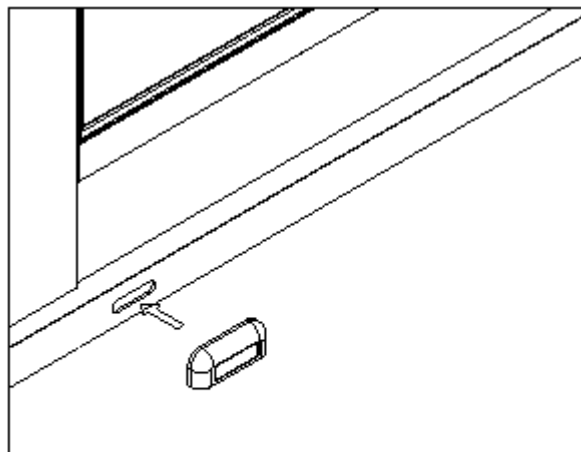
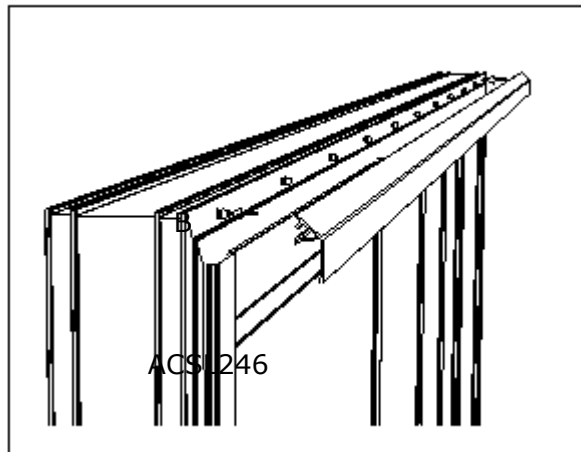
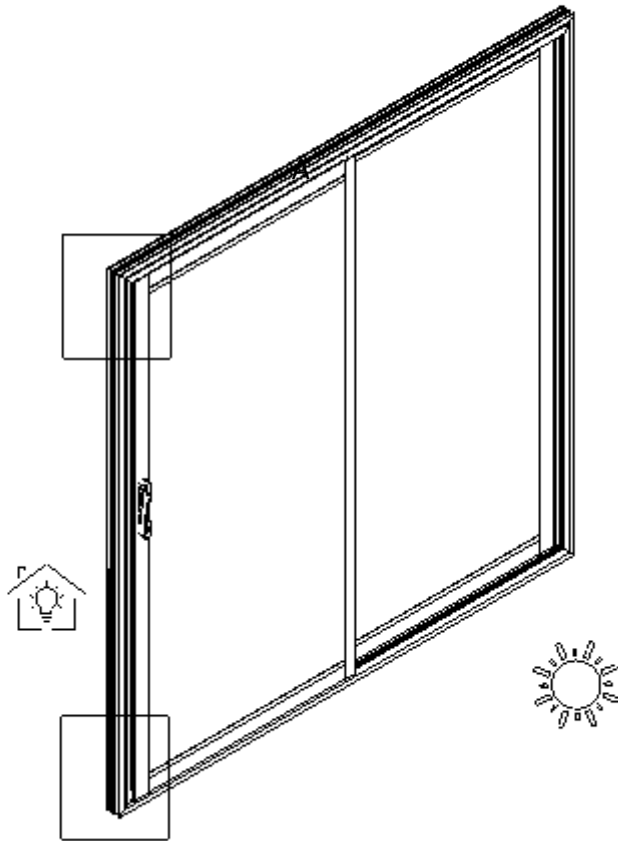

Plan: 14
Positions: TU51

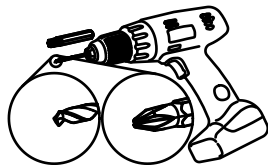
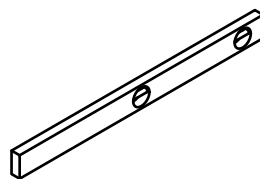
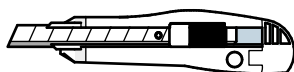
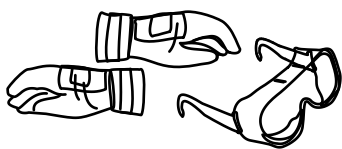
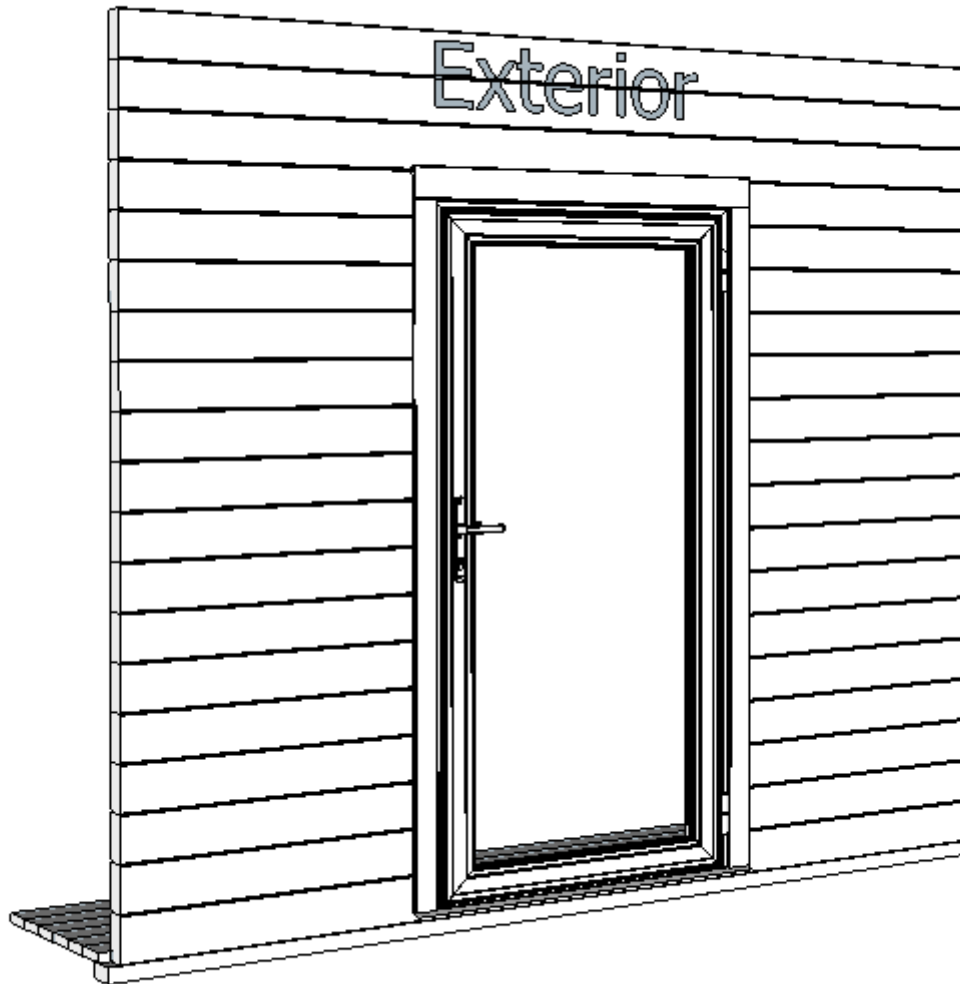

I

Plan: 14
Positions: TP, Sis



QKRPP3-5x50Zn

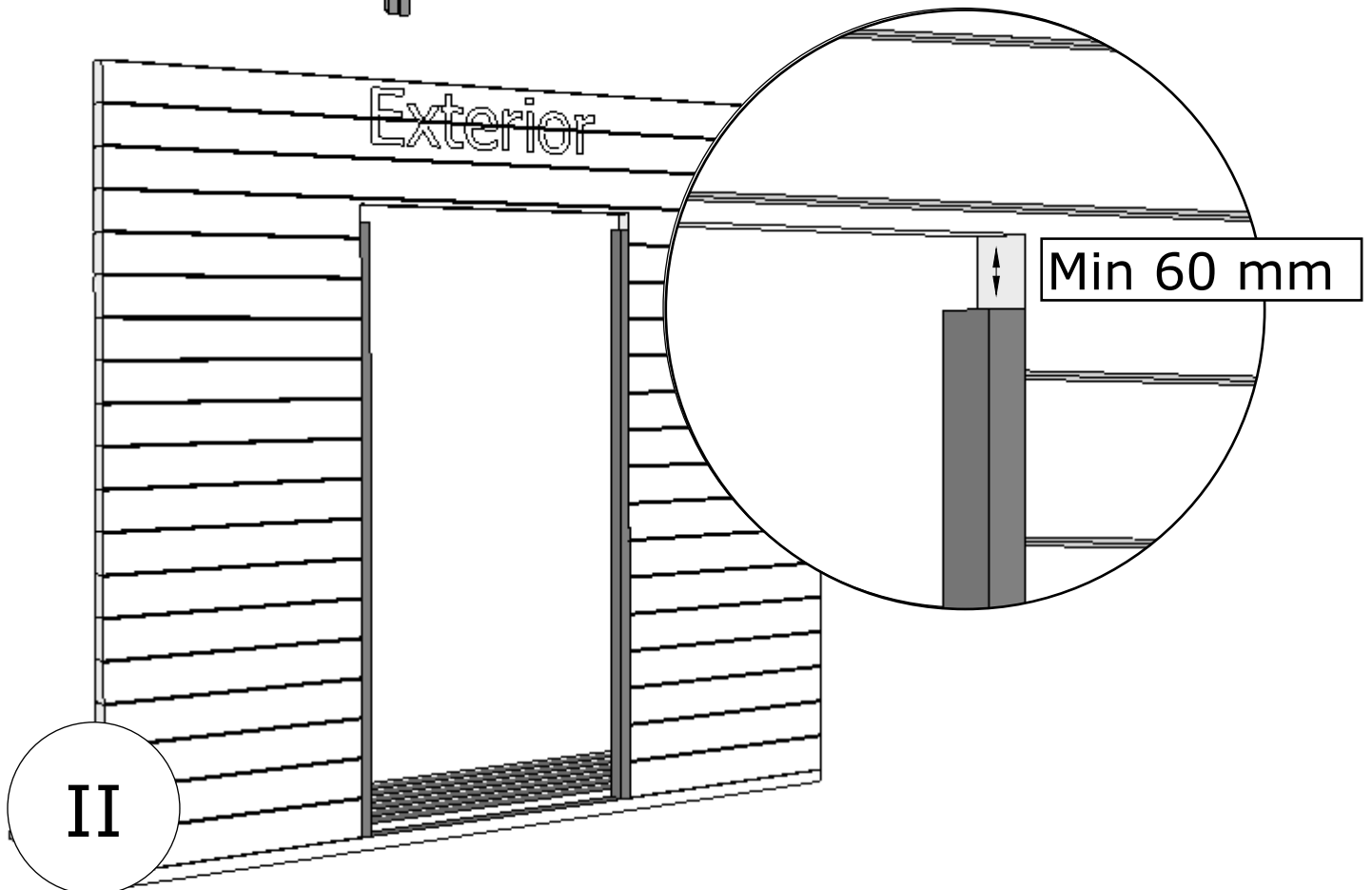
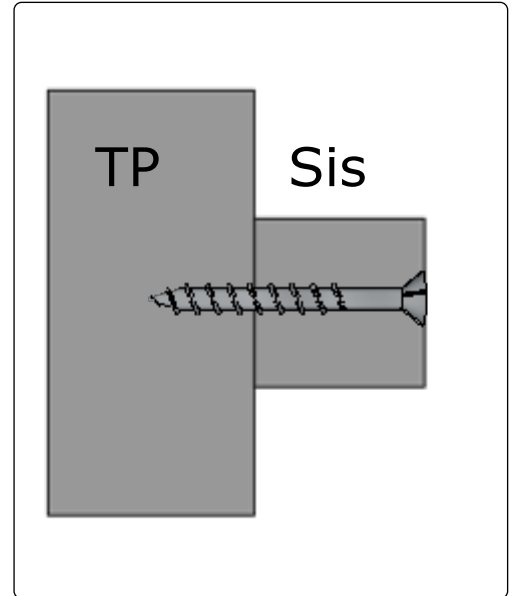
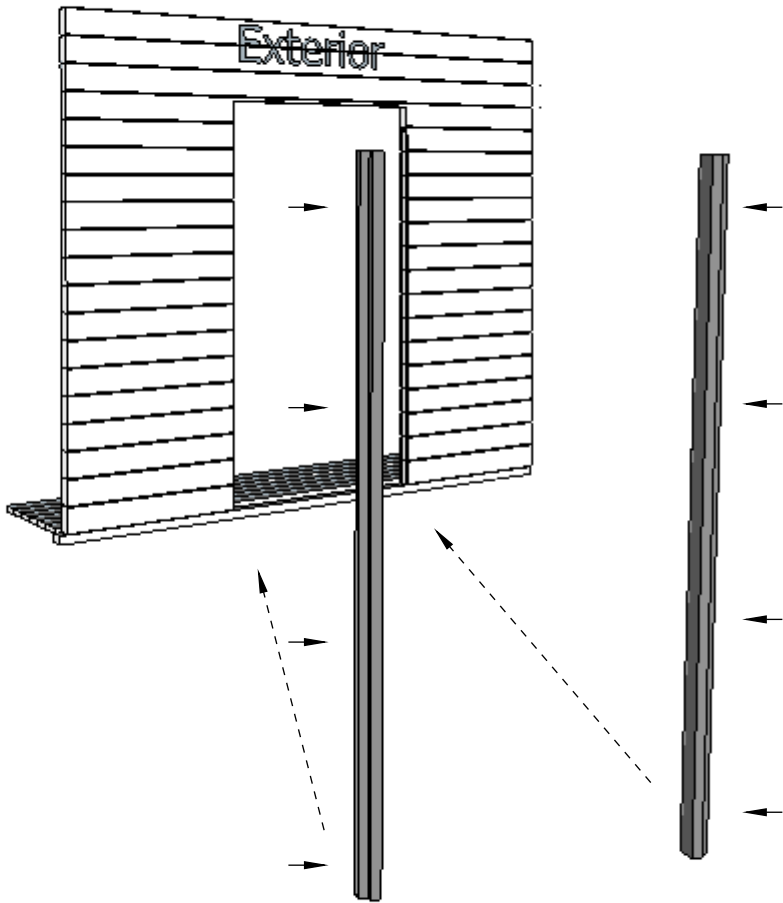

II

Plan: 14
Positions: Sla



QKRPP3-5x50Zn

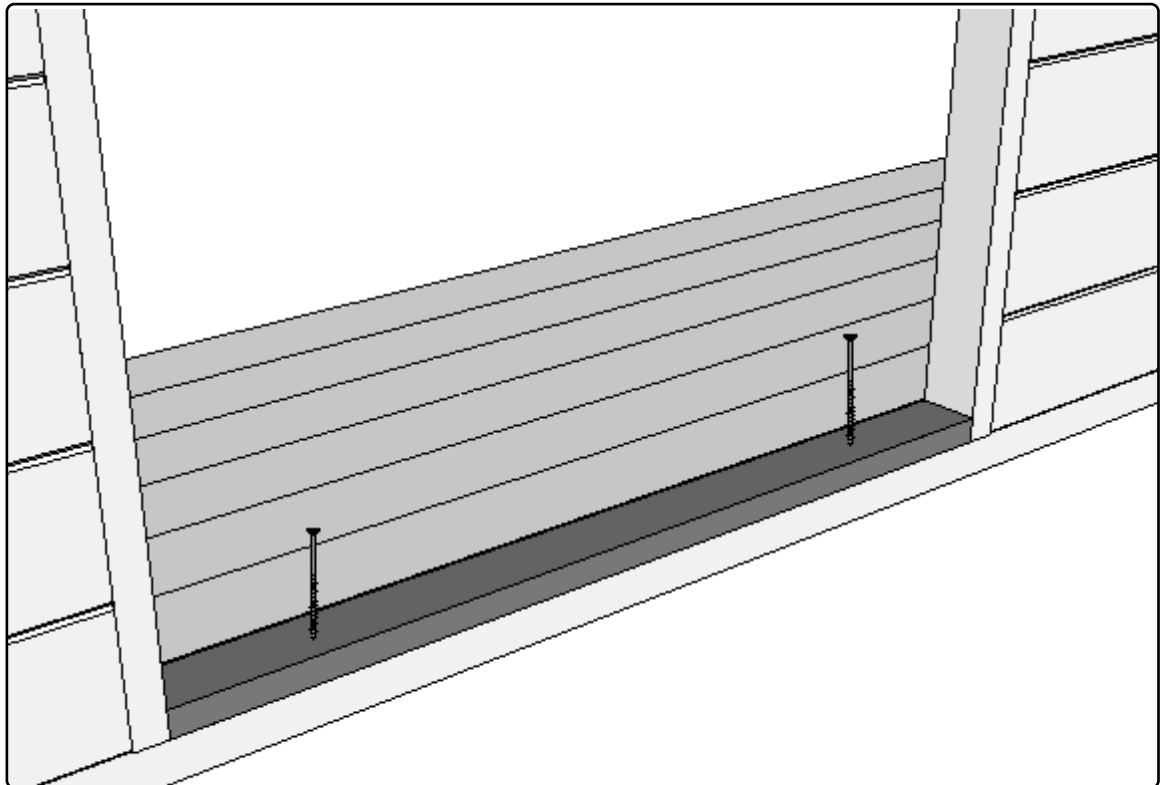
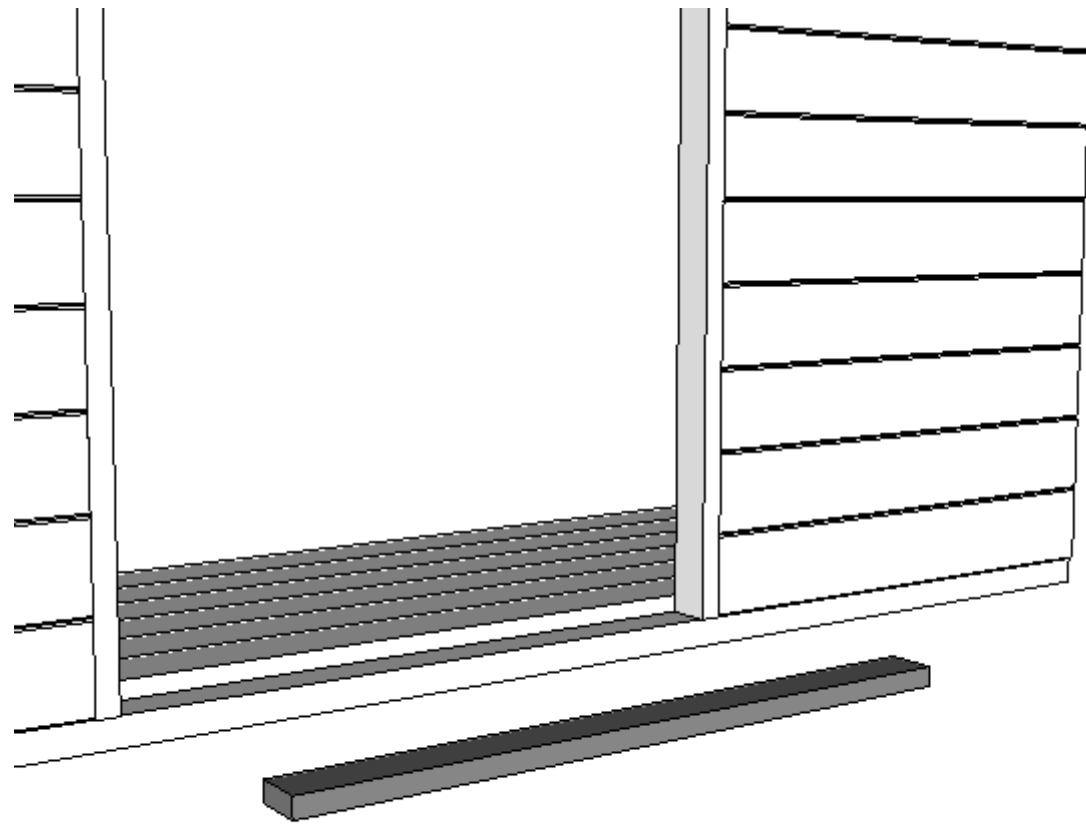

III

Plan: 14
Positions: QP40x30x1109MU

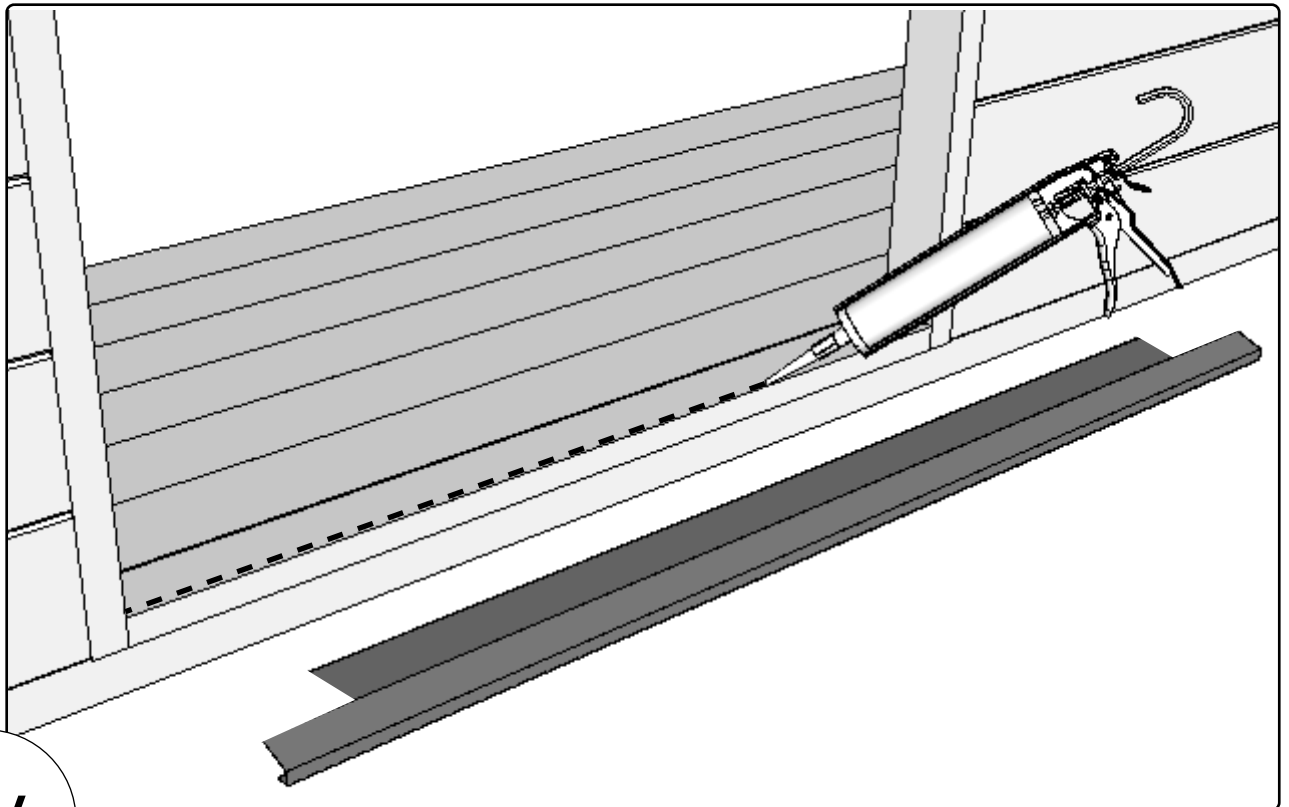
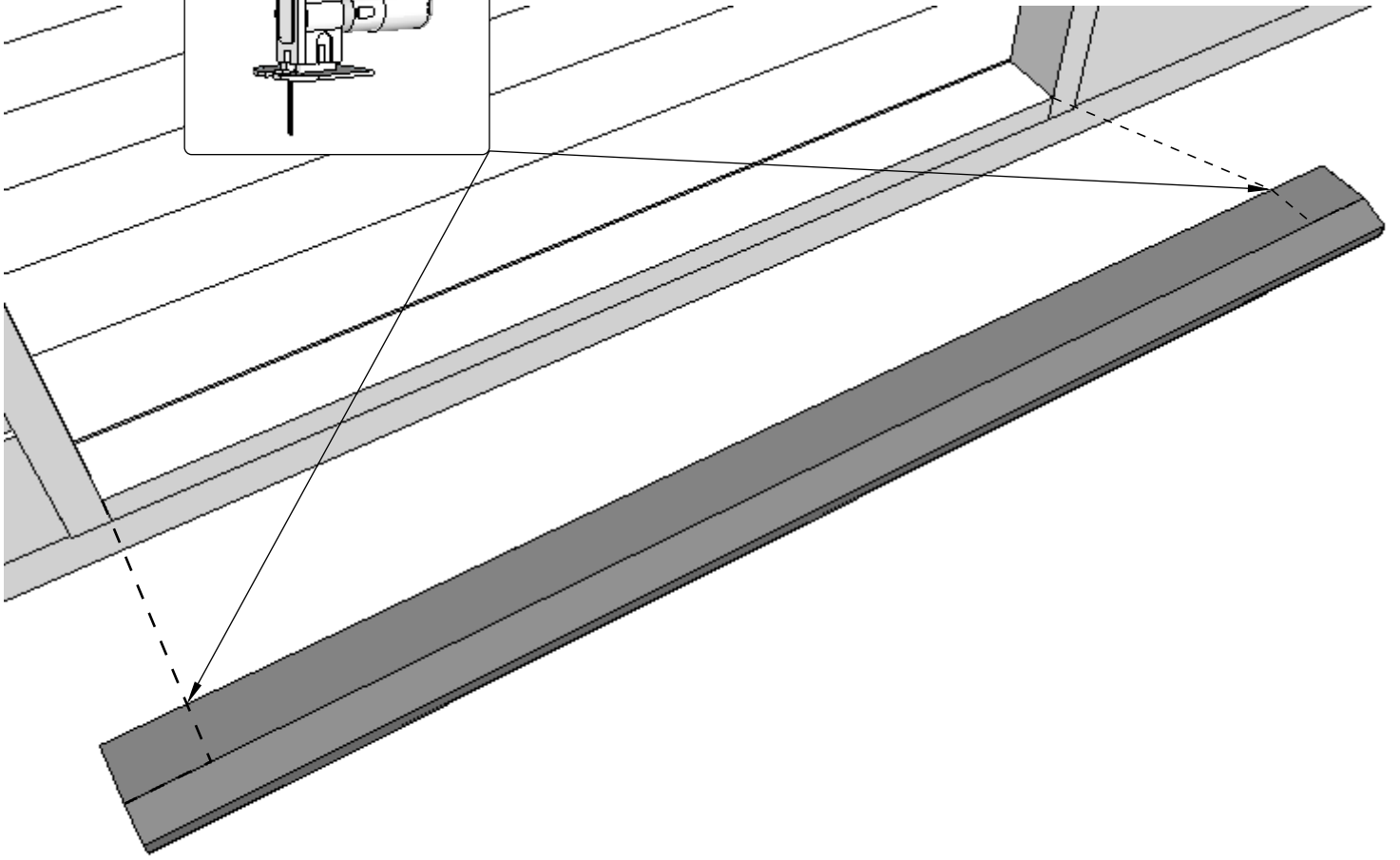
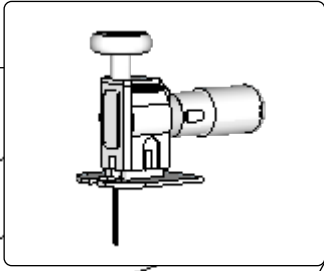

IV

Plan: 14
Positions:

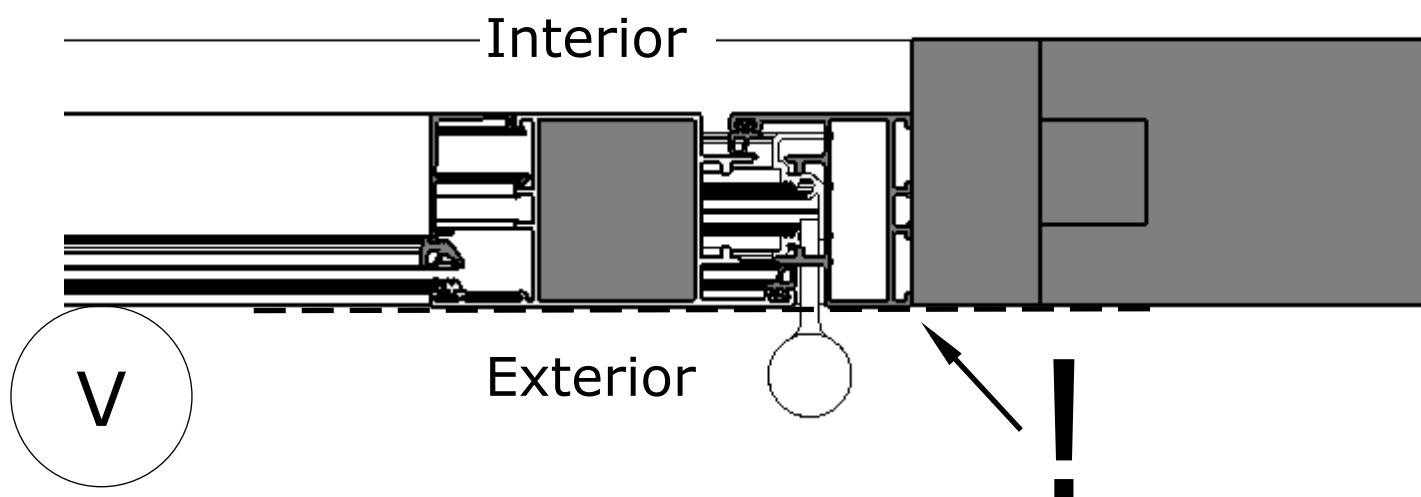
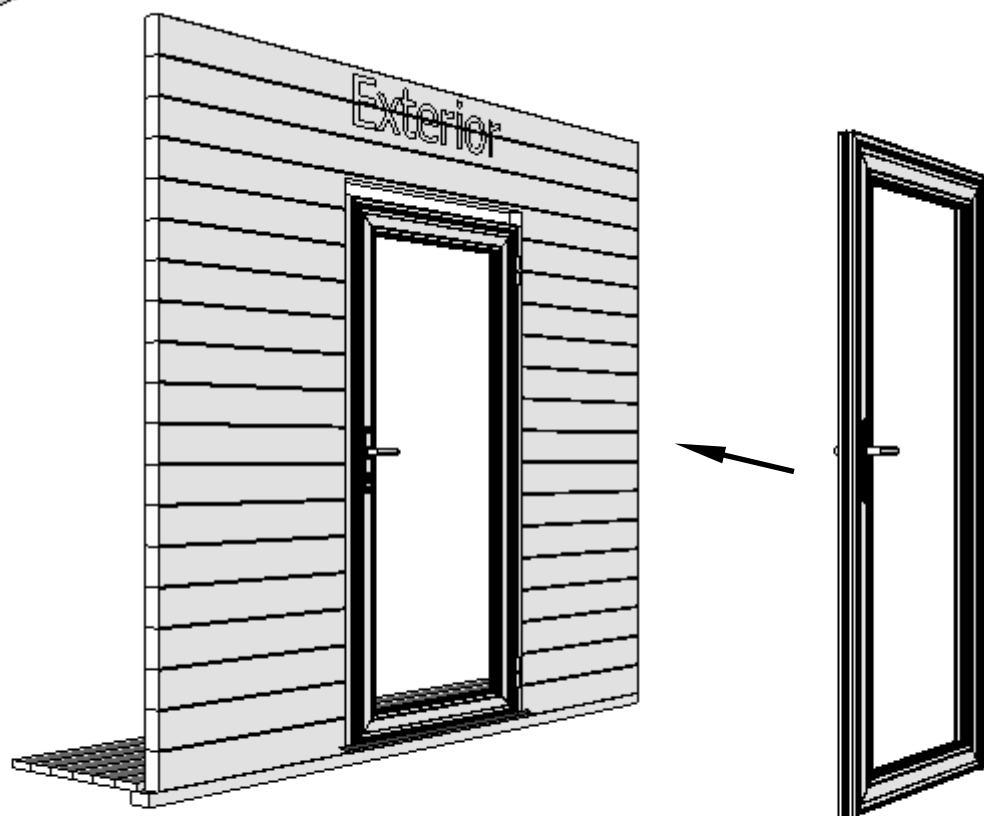
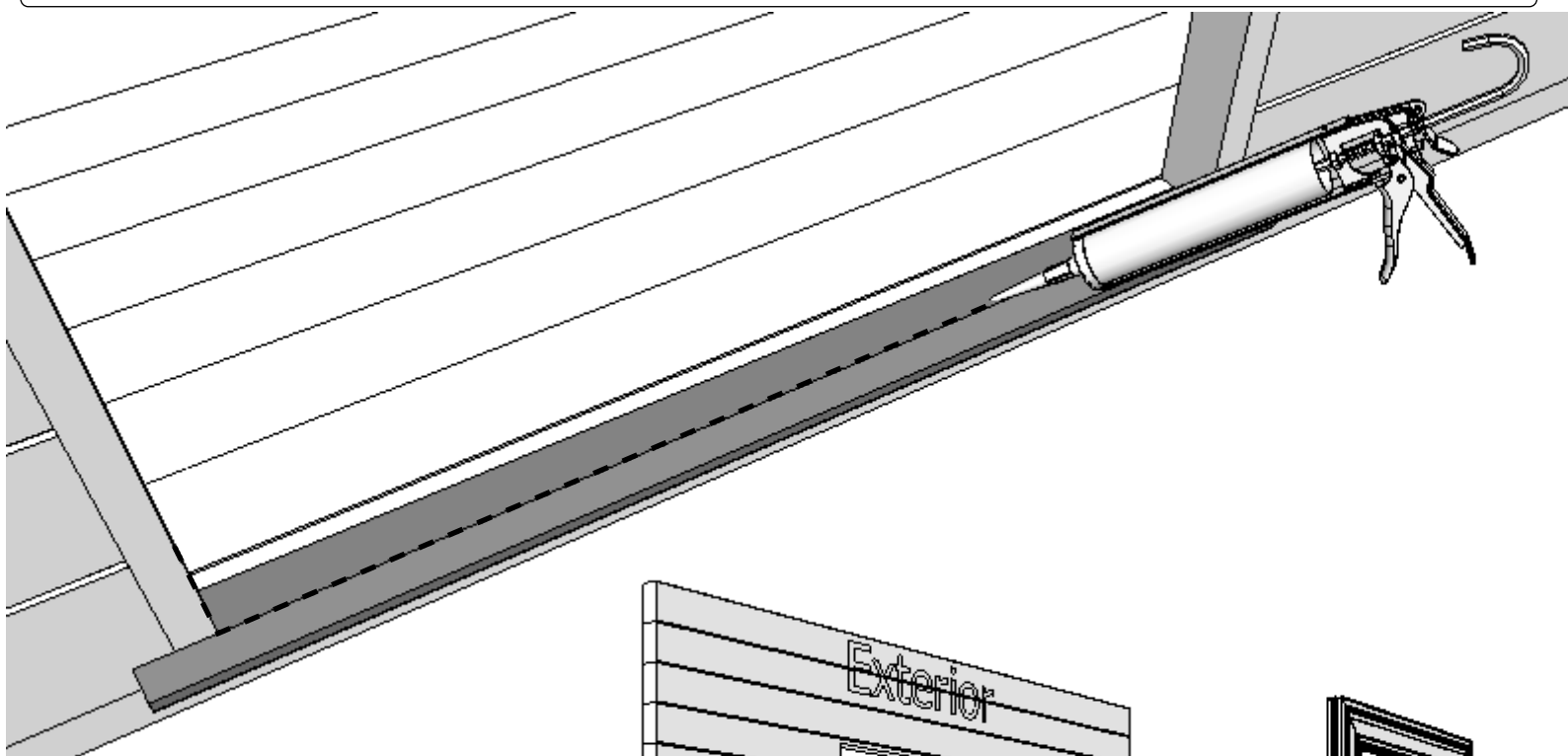

Plan: 14
Positions: QLY-ACWKS92
QLY-LWB02

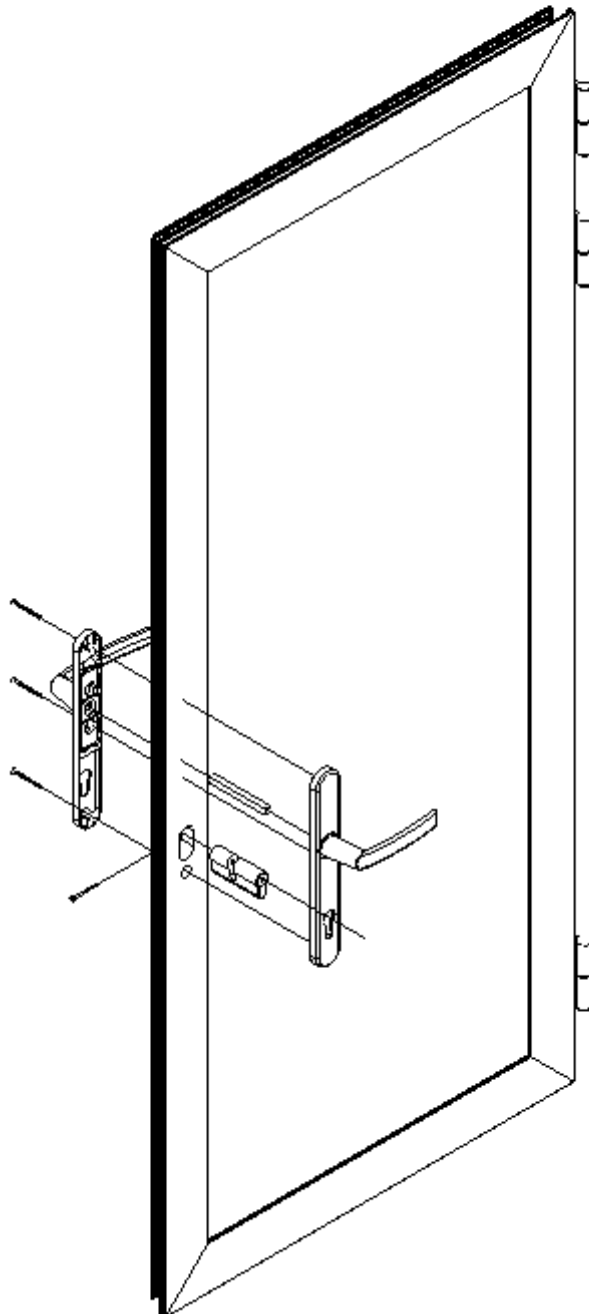
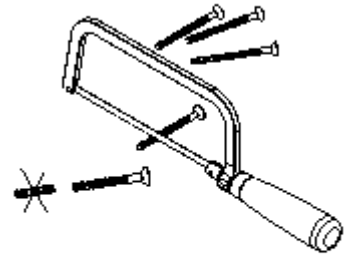
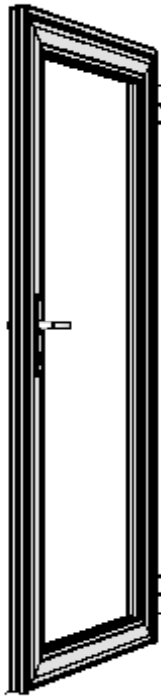
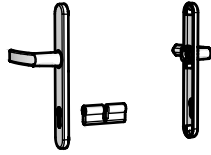

Plan: 14

Positions:

 QKRYP5x60Zn

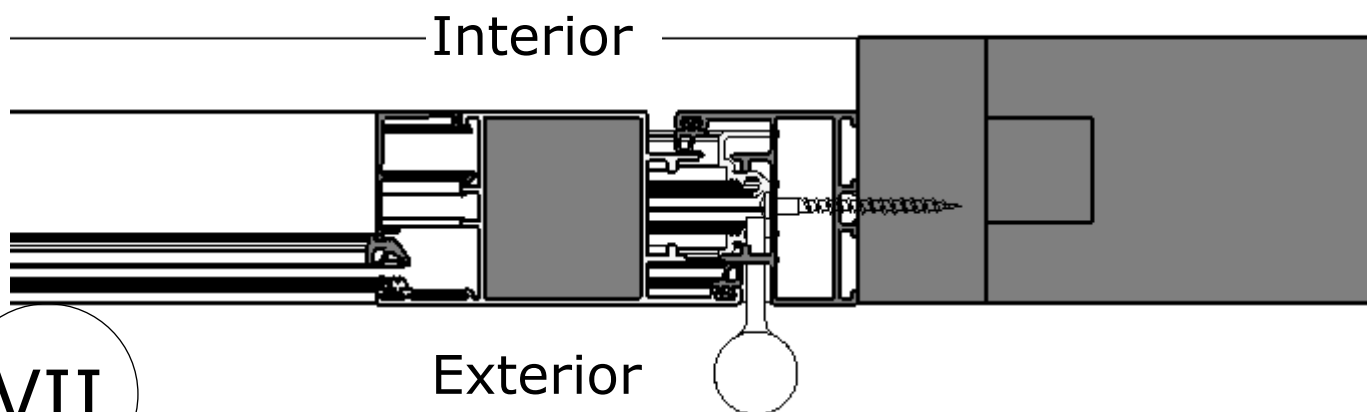
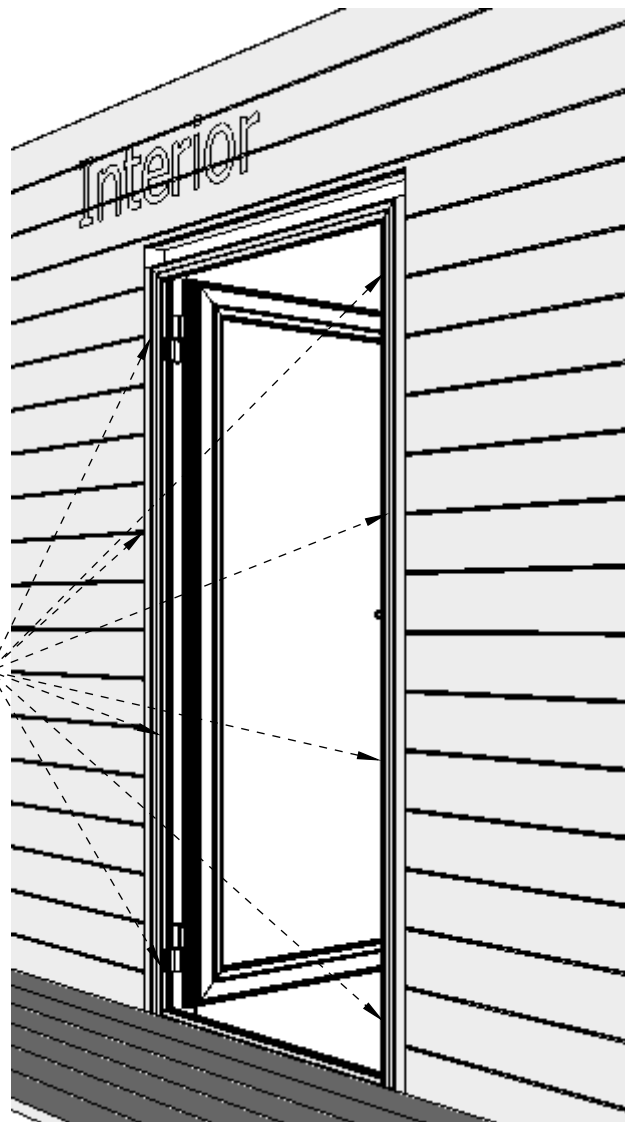

VII

Plan: 14

Positions: Sis

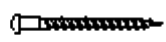

QKRYP5x60Zn

Sis

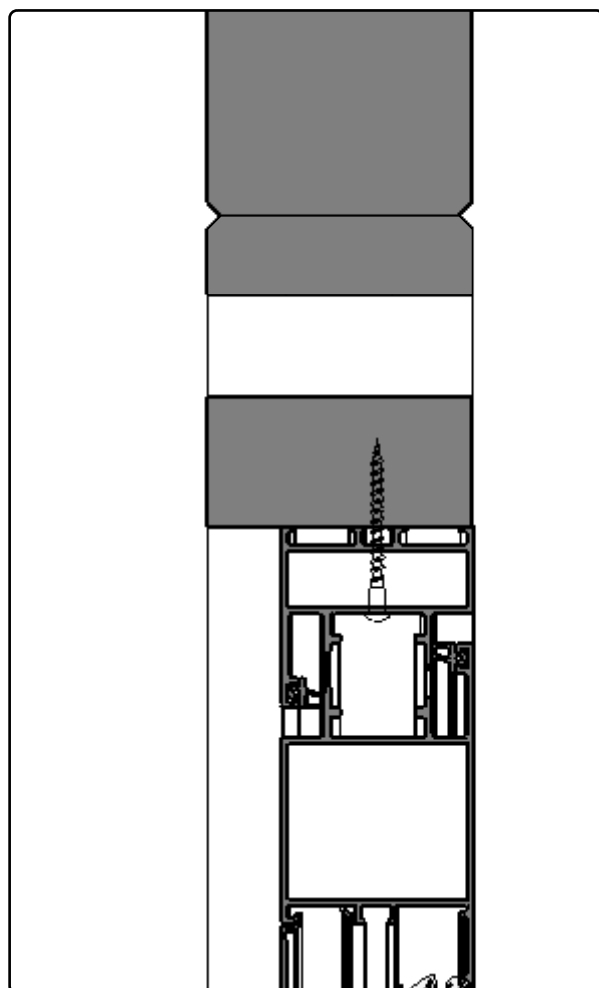
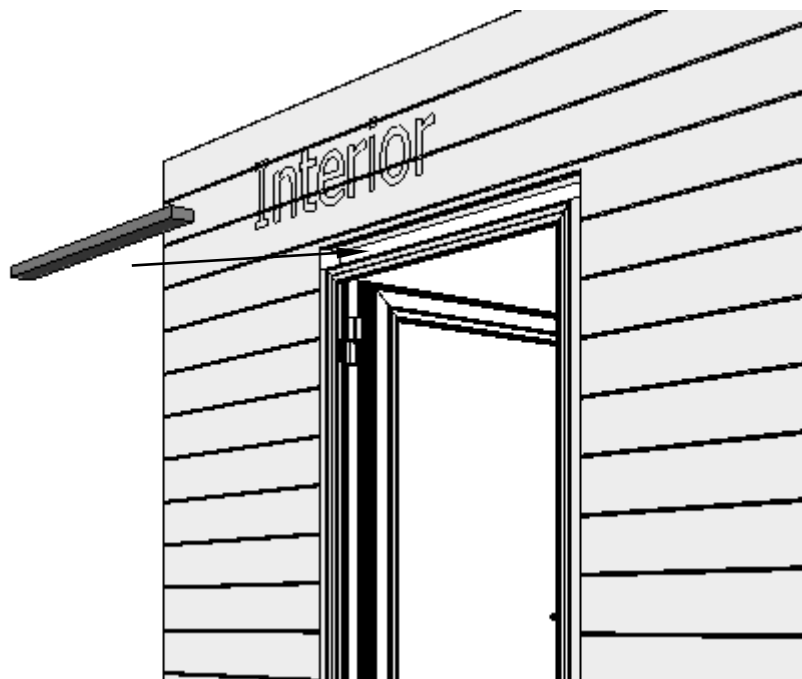

VIII



Plan: 14

Positions:

QT140-1



IX

Plan: 14

Positions: COB



QKRPP3-5x50Zn

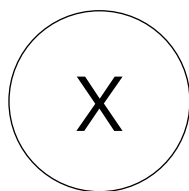

Plan: 14
Positions:

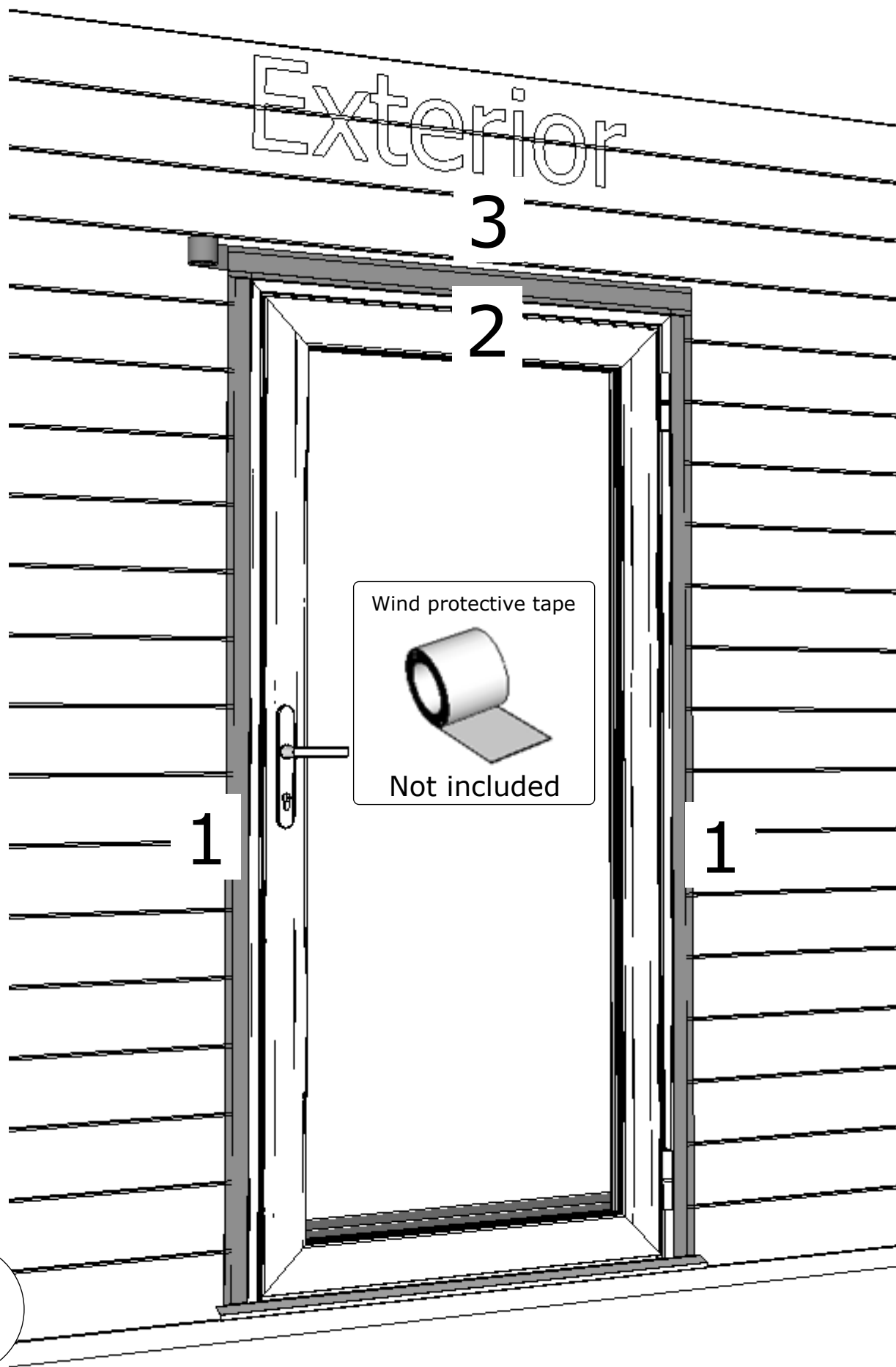

Plan: 14
Positions: COB



QKRPP3-5x50Zn

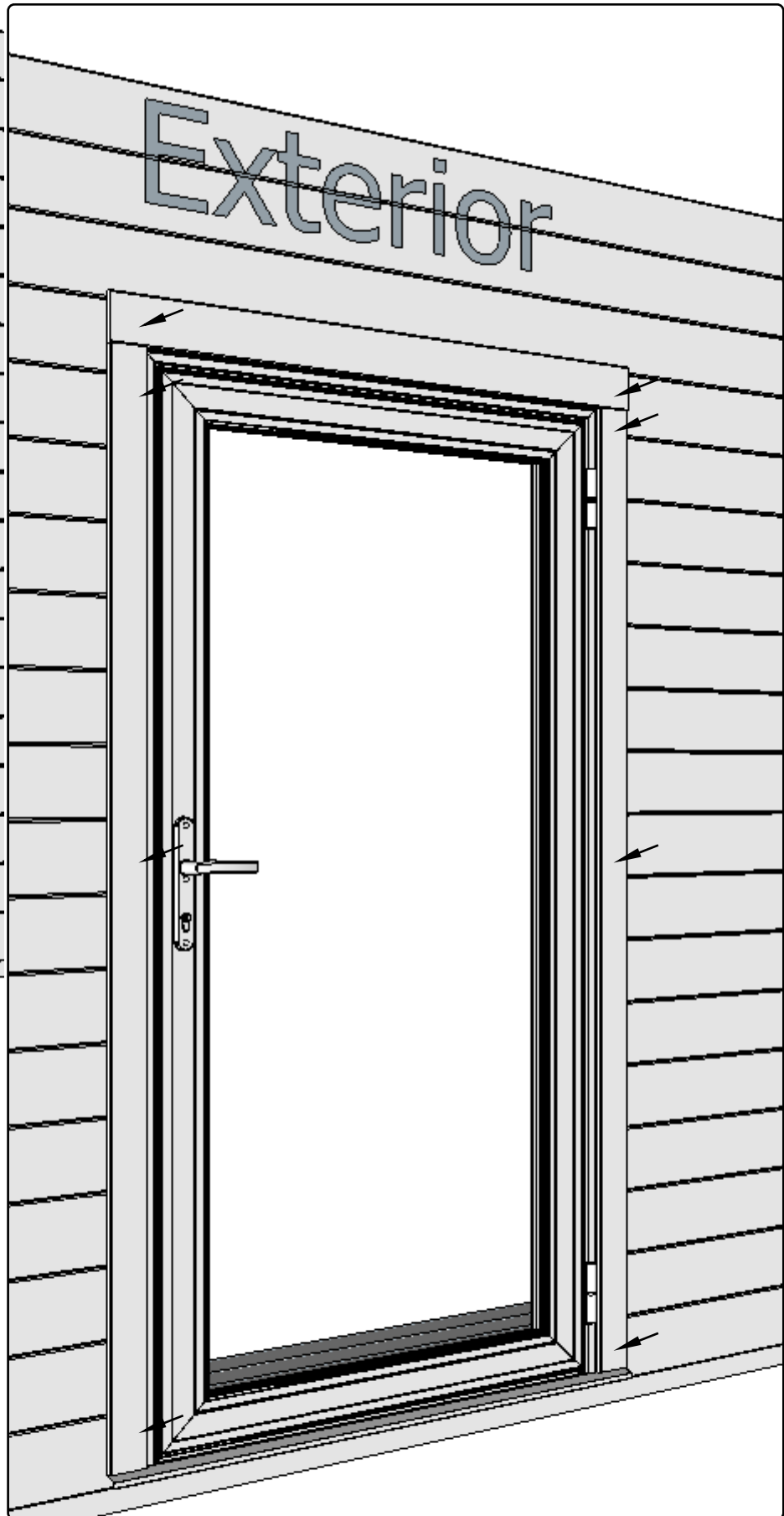
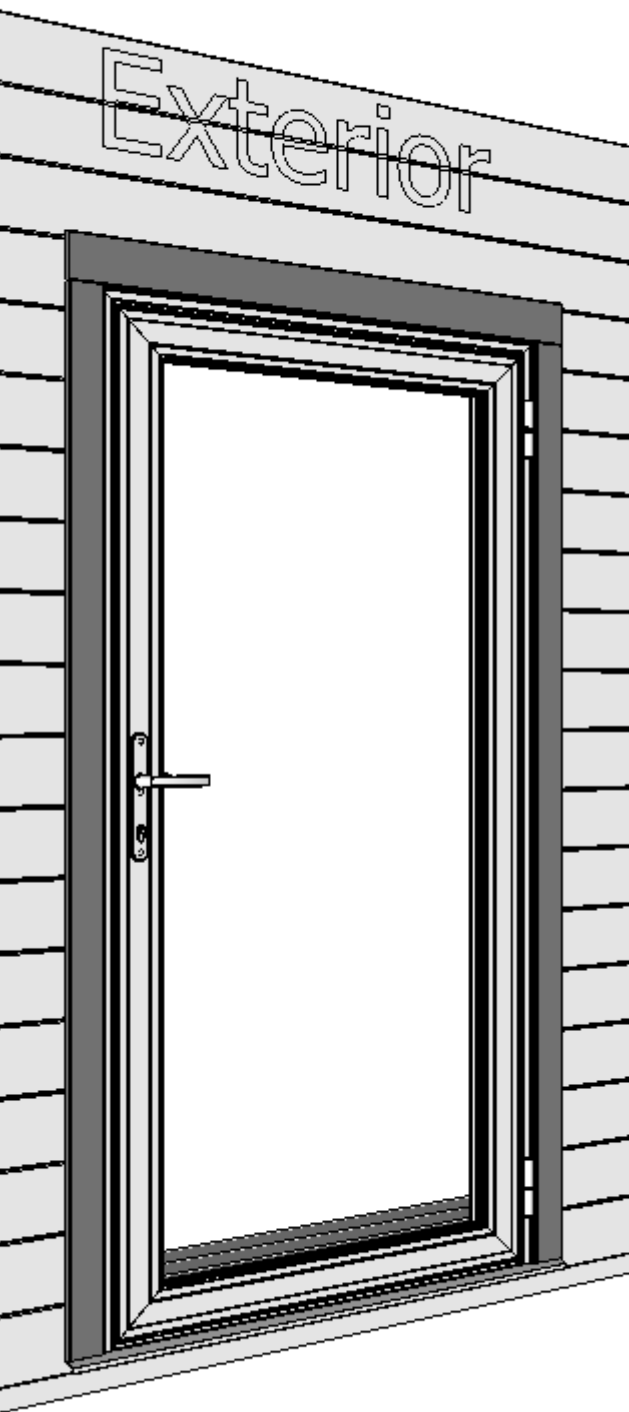

Plan: 14
Positions: COB

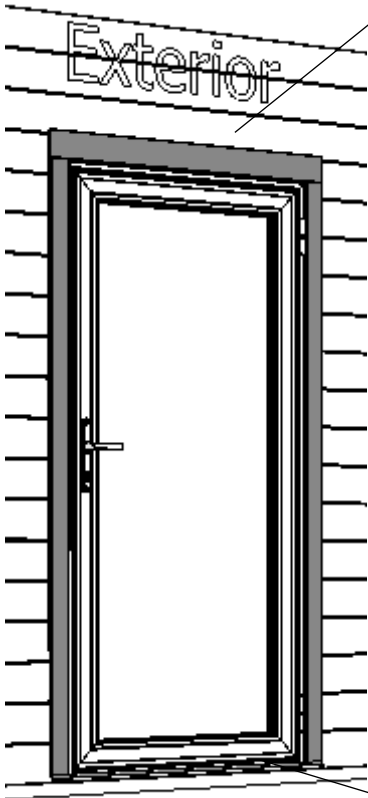

Interior

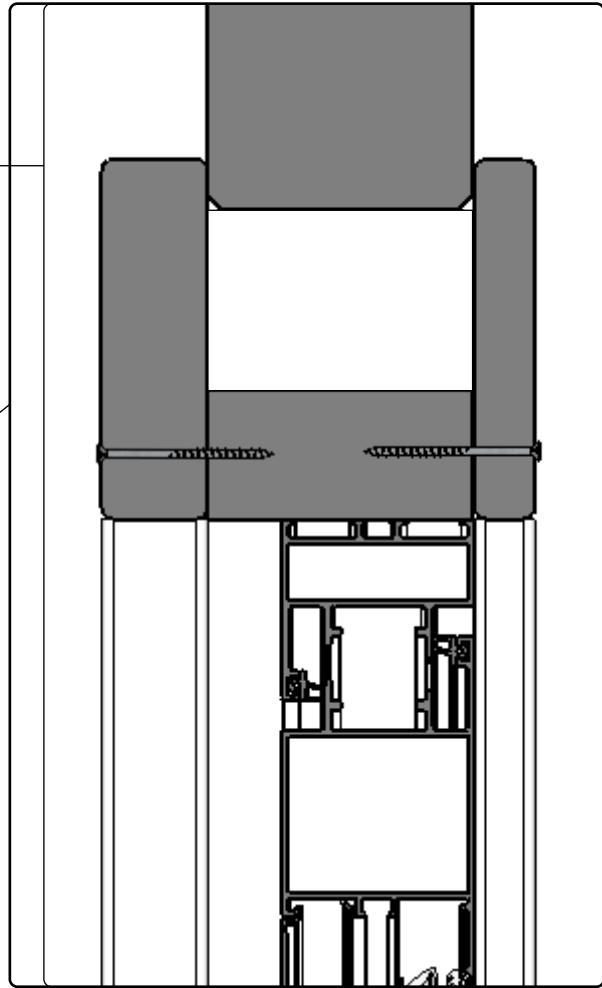

Exterior

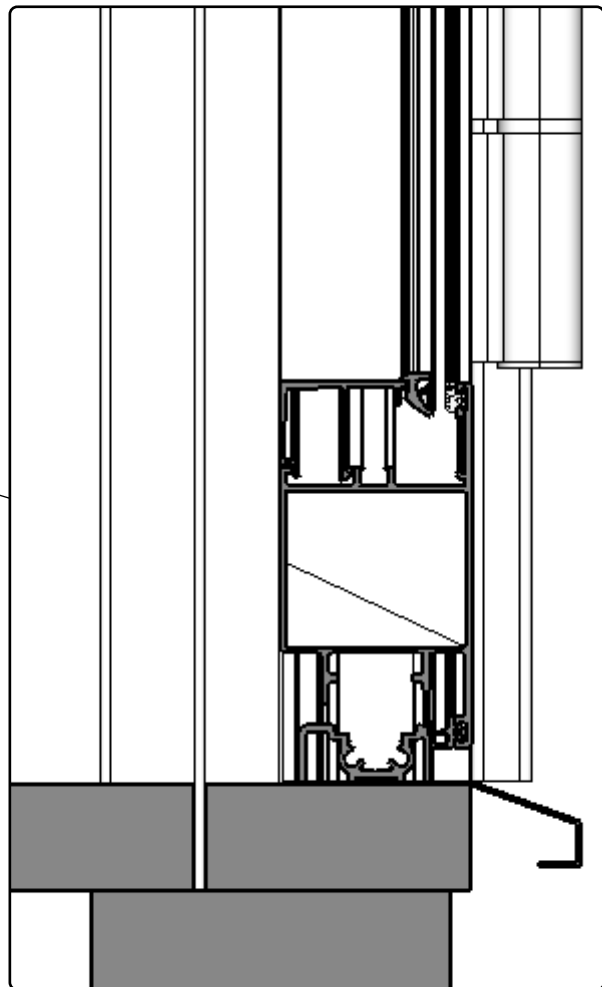

Plan: 14
Positions: COB

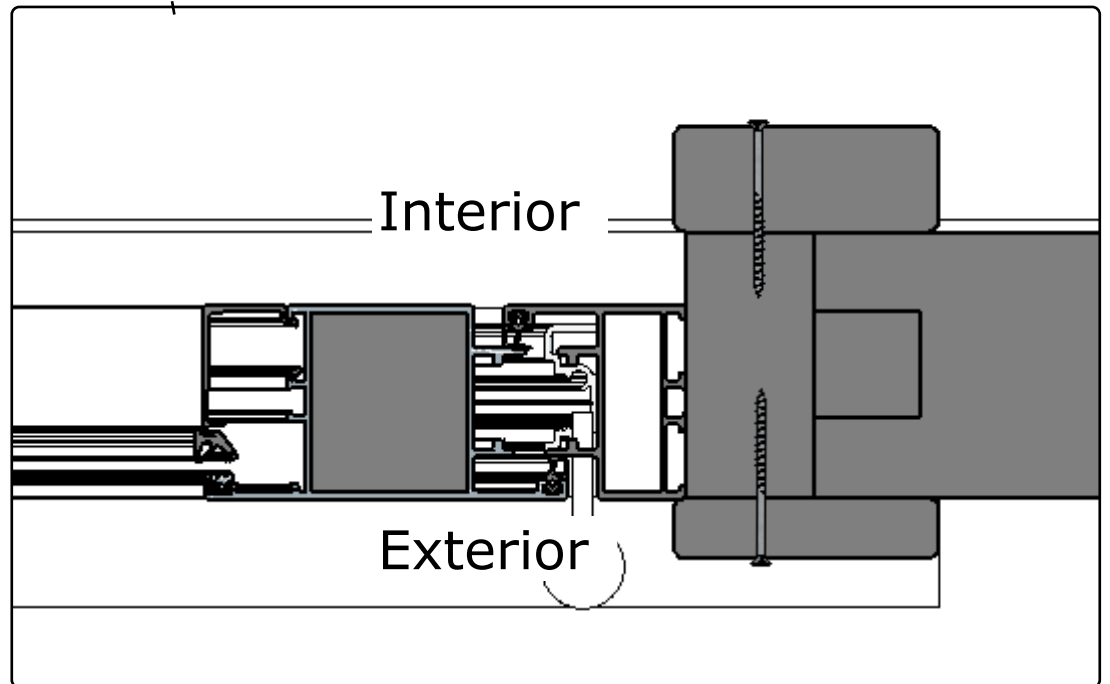
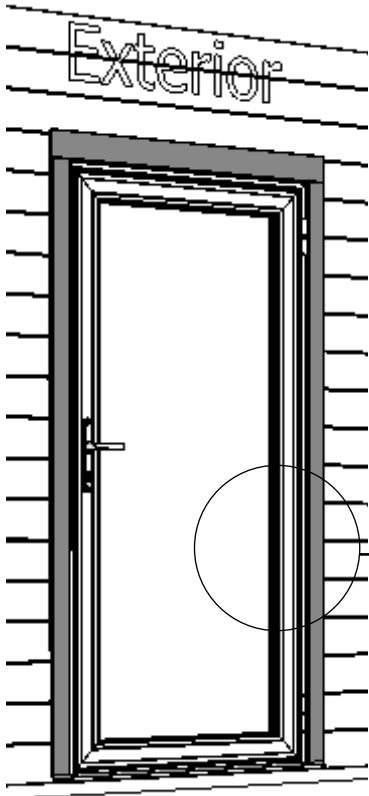

Plan: 13

Positions: A51-13

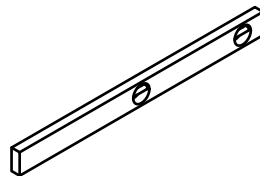
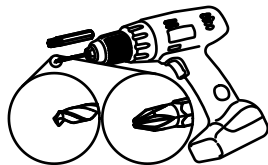
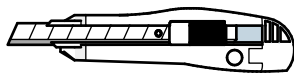
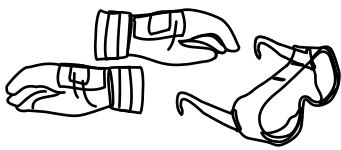
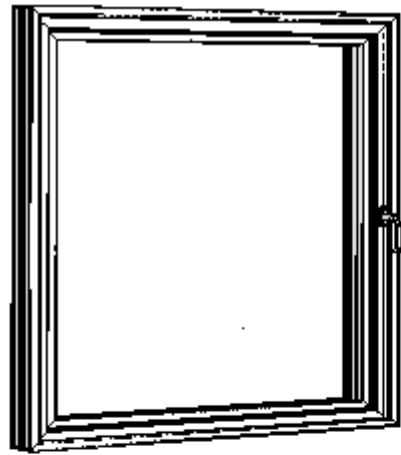
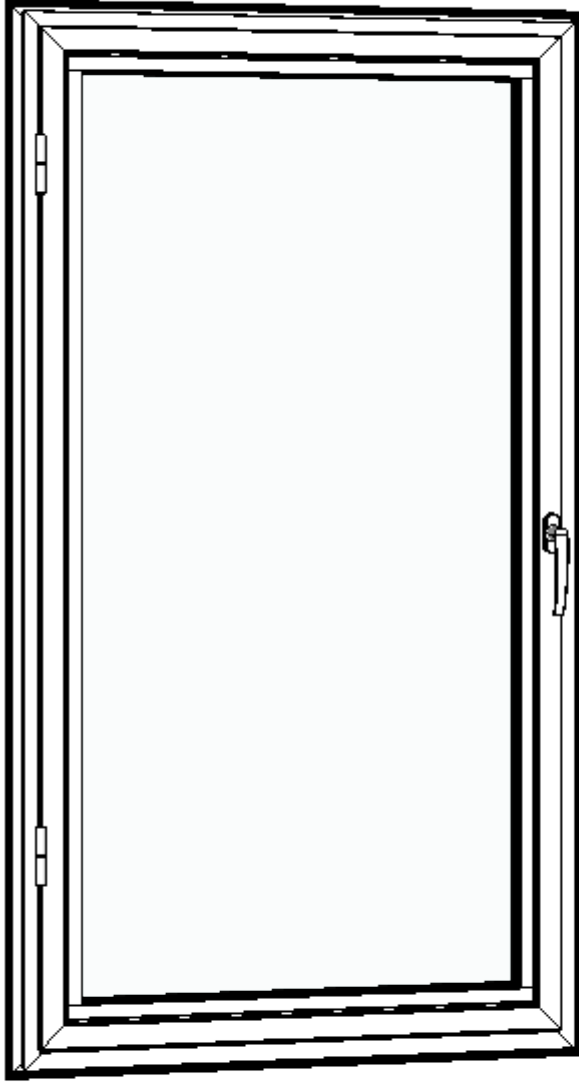

I

Plan: 13

Positions: QLY-ACAMAS29
QLY-ACAMAS33

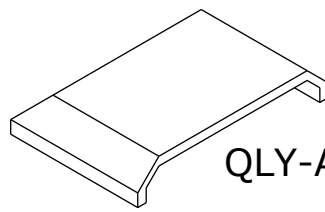

QLY-ACVG45Z

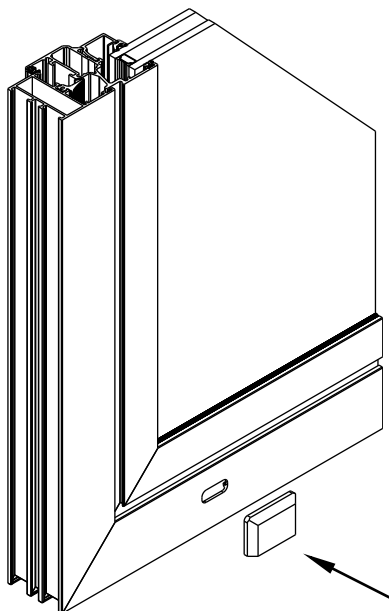
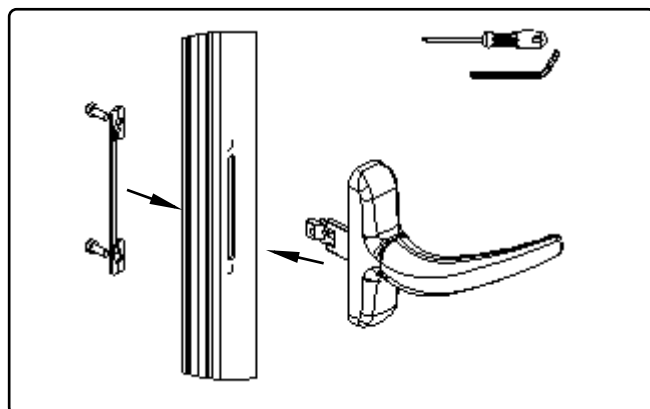
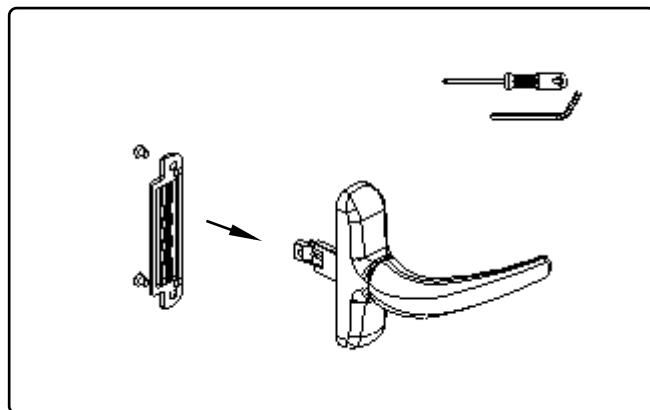
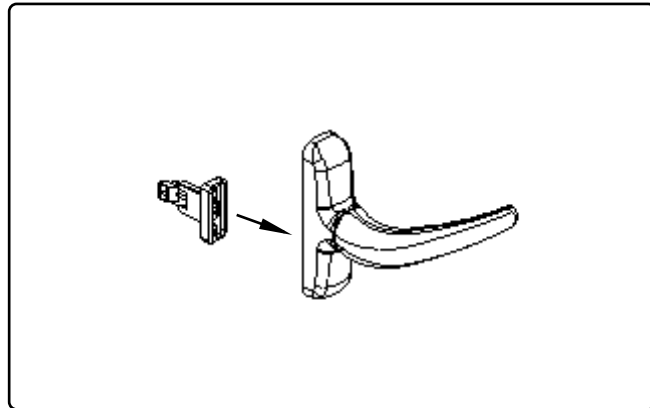
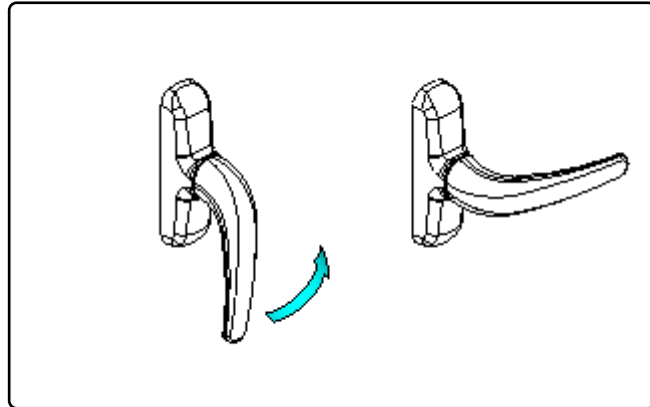
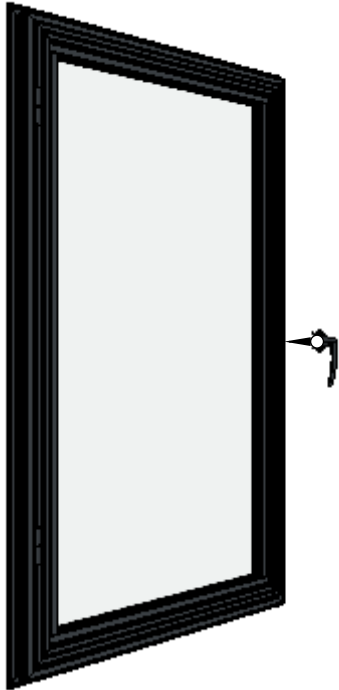

QLY-ACVG45Z

II

Plan: 13

Positions: COB



QKRPP3-5x50Zn

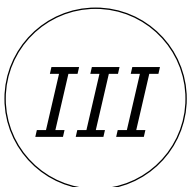
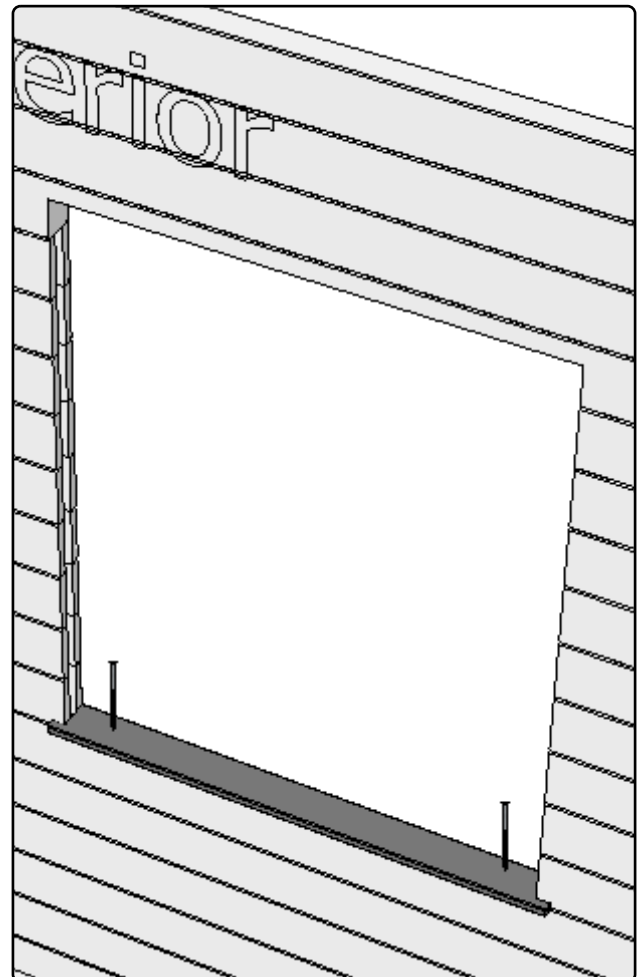
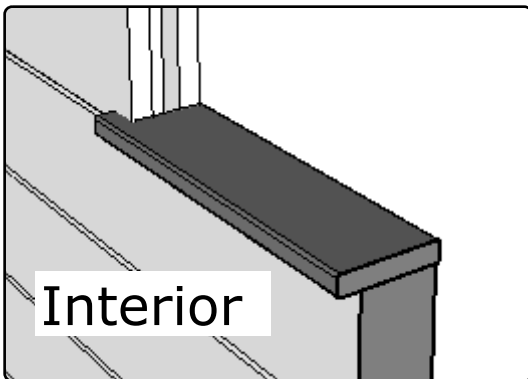
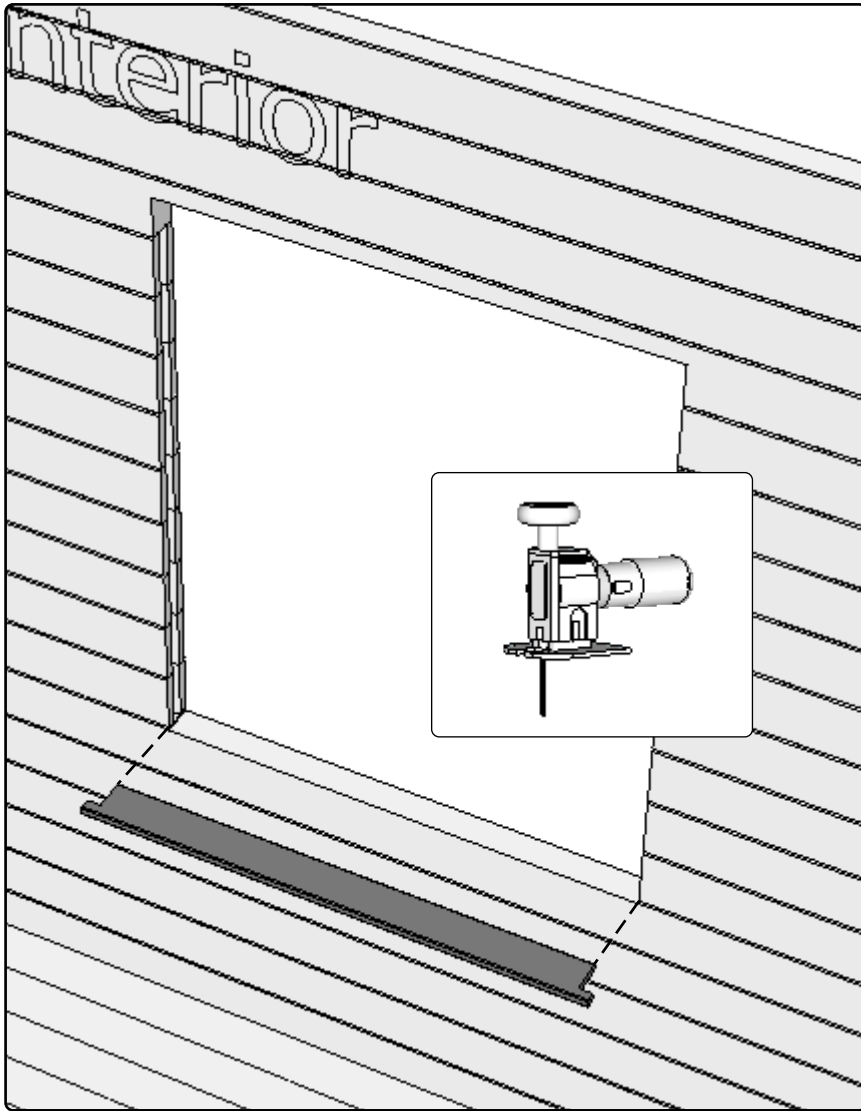

Plan: 13

Positions: TP
Sis



QKRPP3-5x50Zn

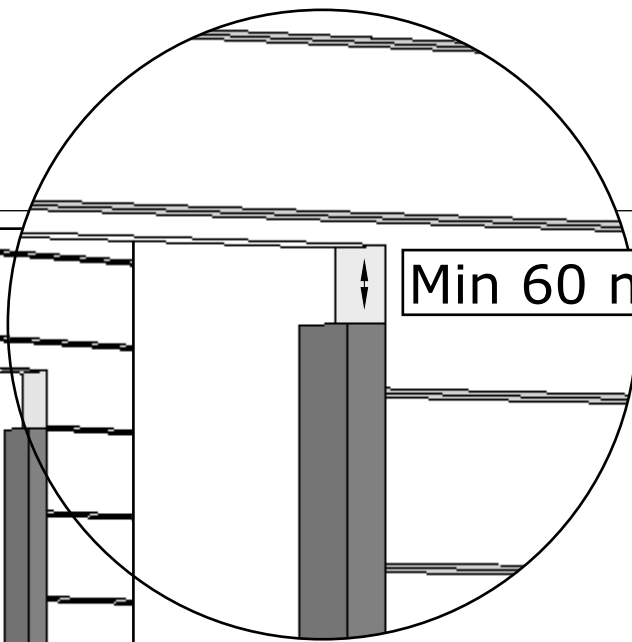
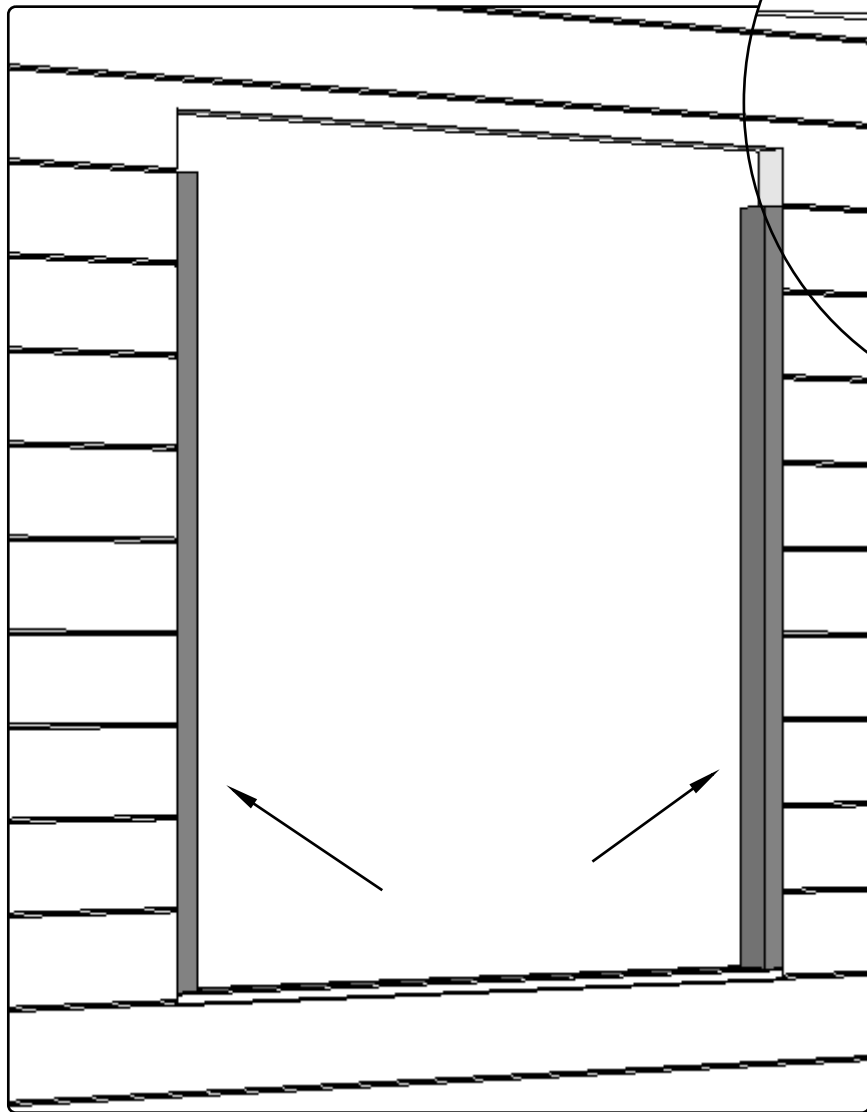

Min 60 mm

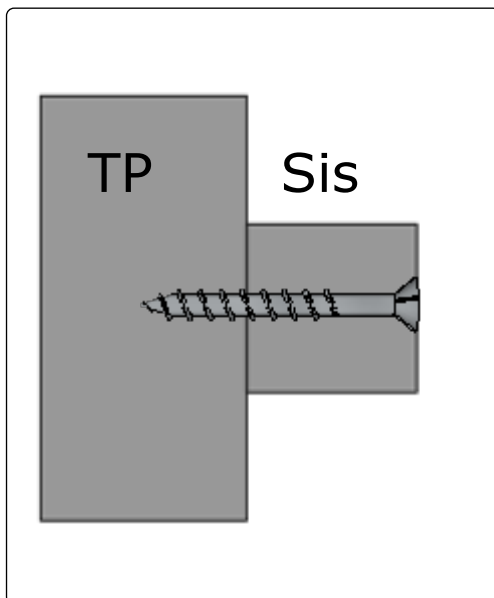
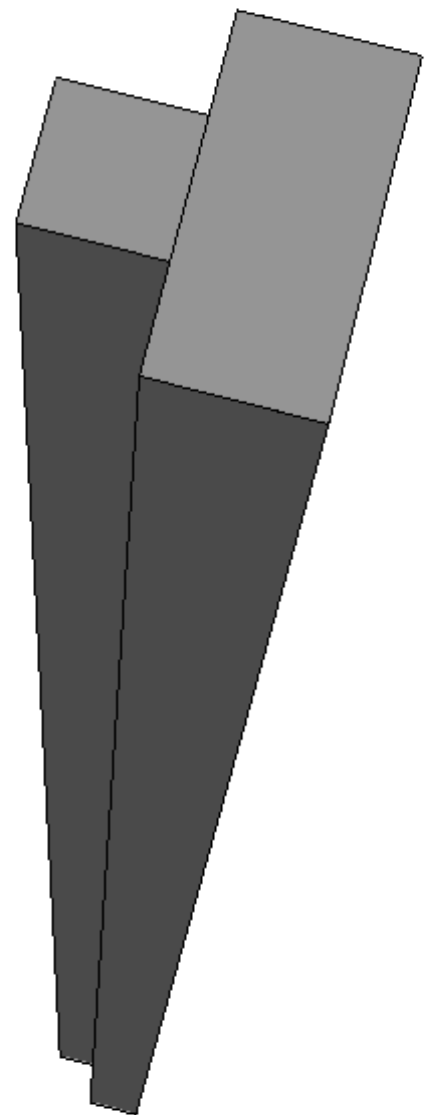

IV

Plan: 13

Positions: QP40x30x740

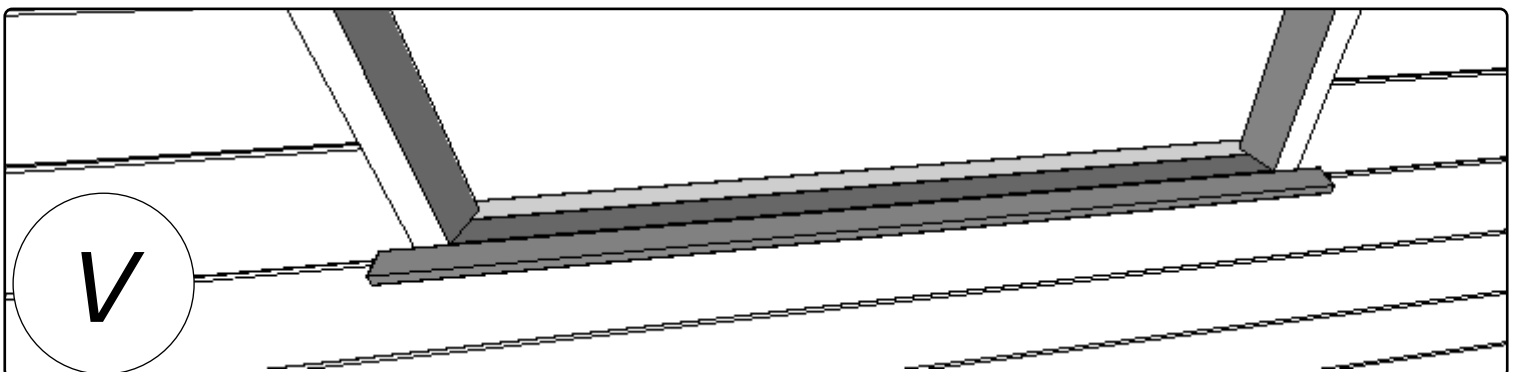
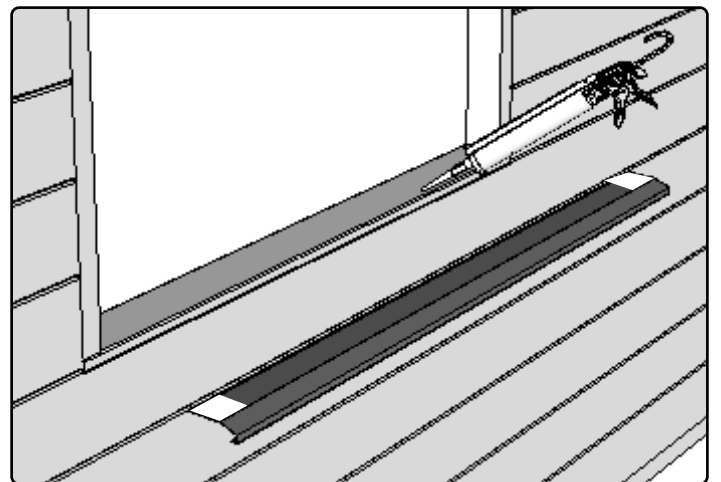
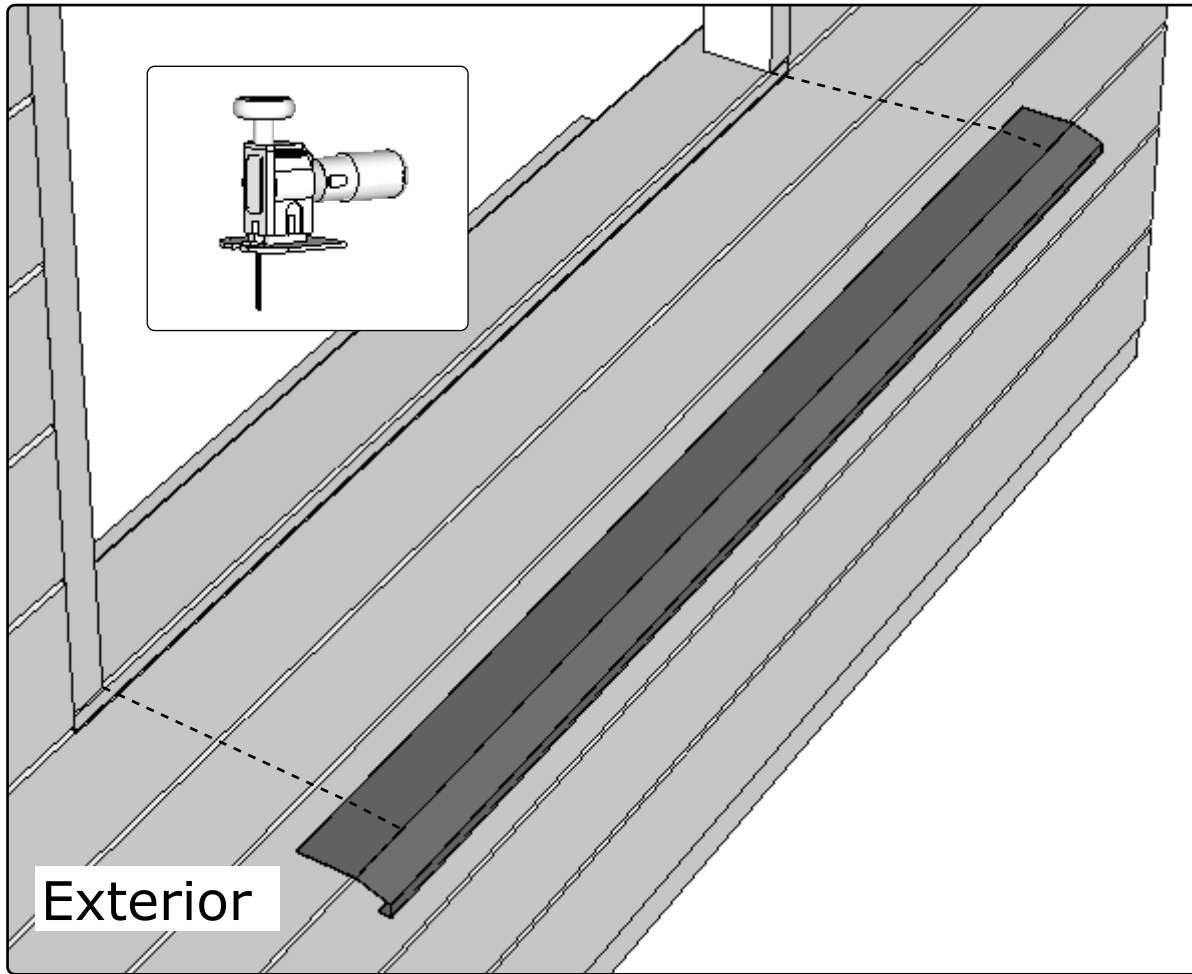

Plan: 13
Positions:

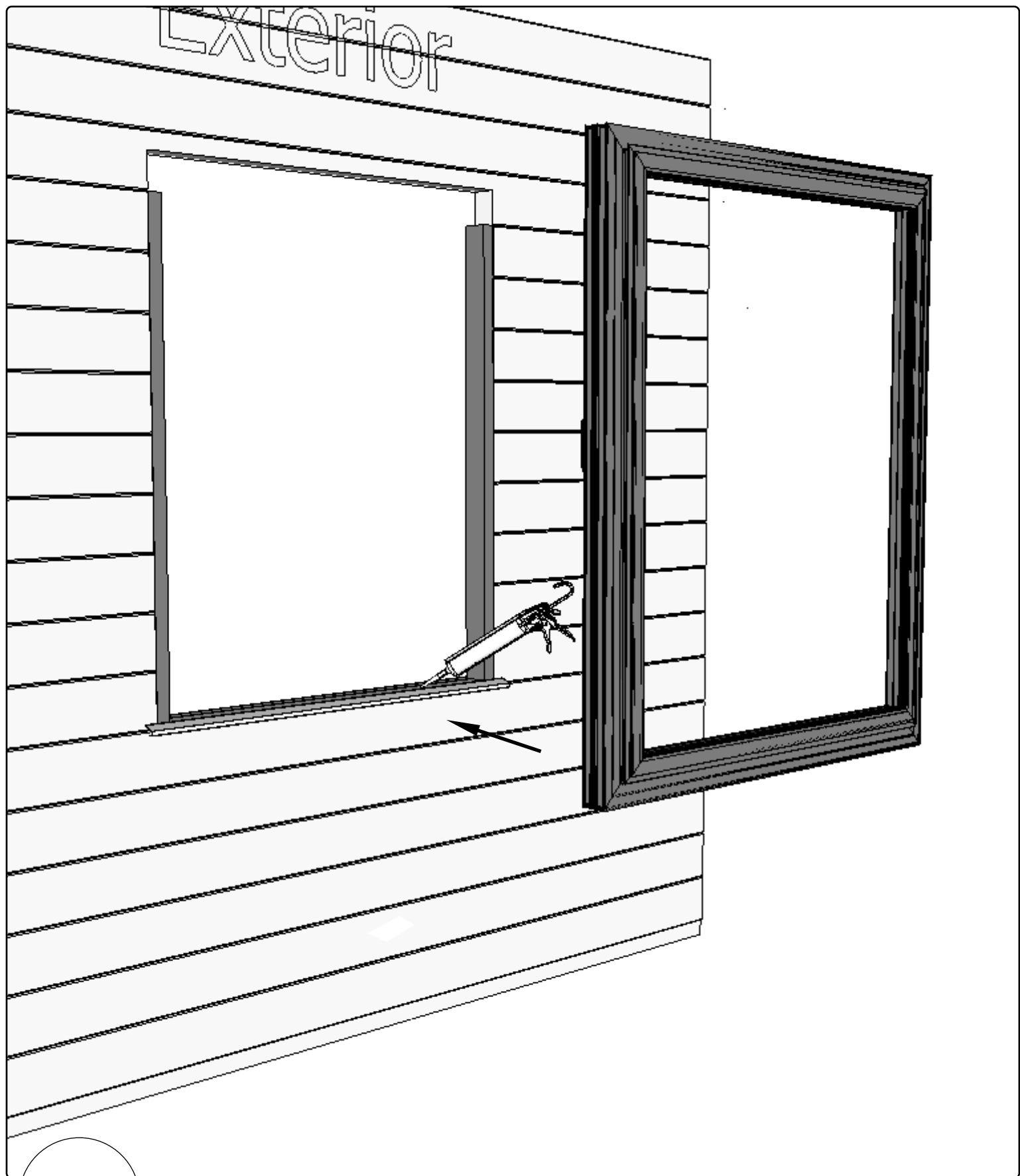

VI

Plan: 13

Positions:

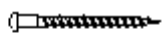

QKRYP5x60Zn

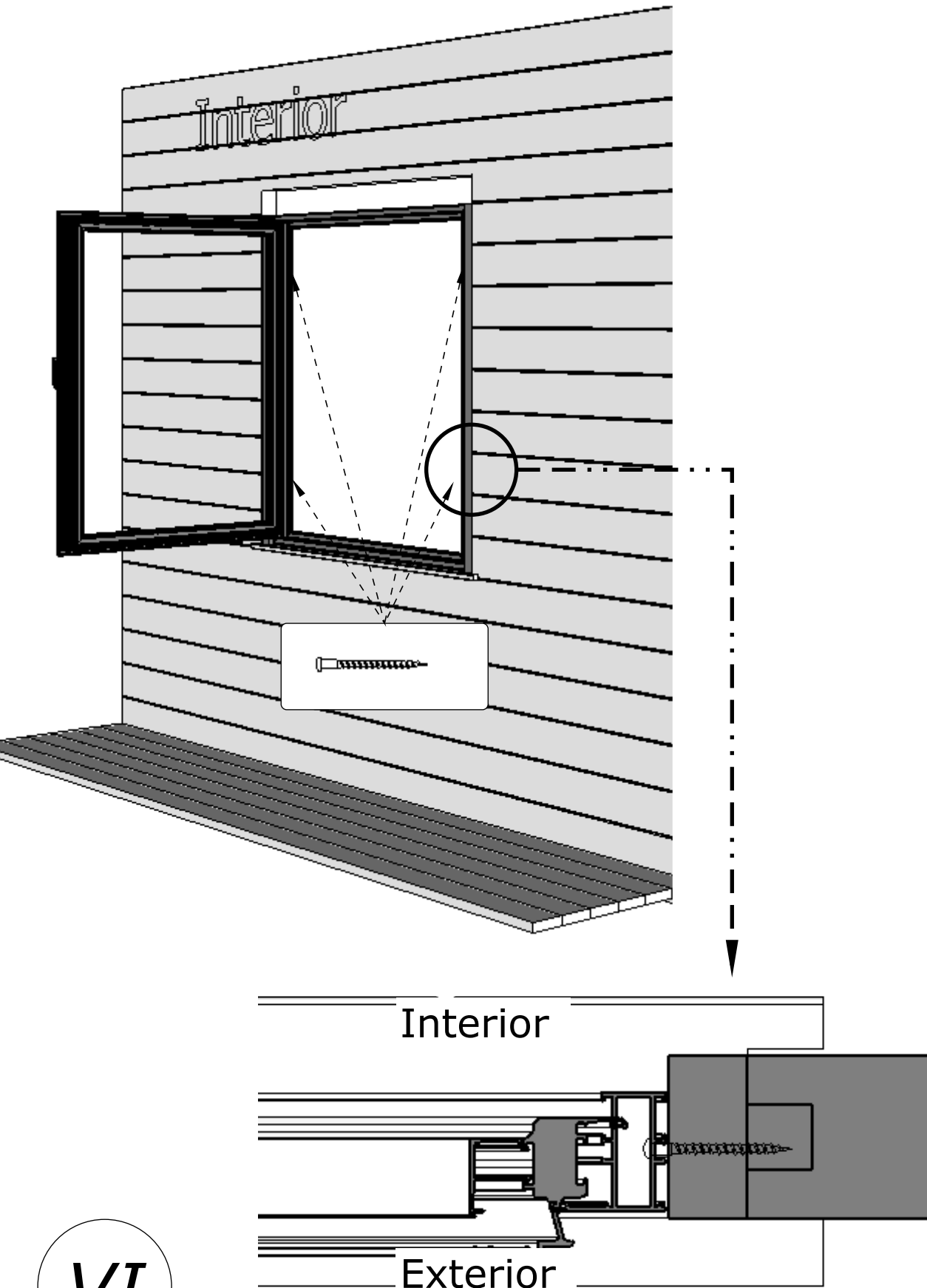

VI

Plan: 13

Positions: Sis

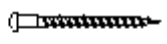

QKRYP5x60Zn

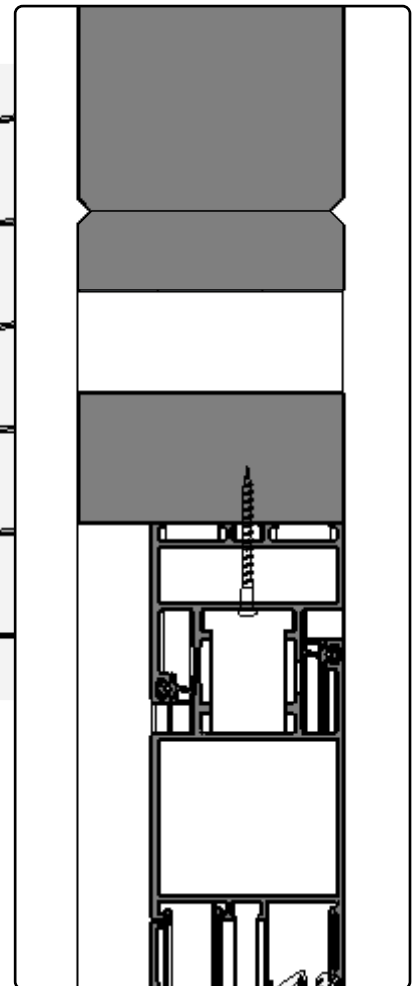
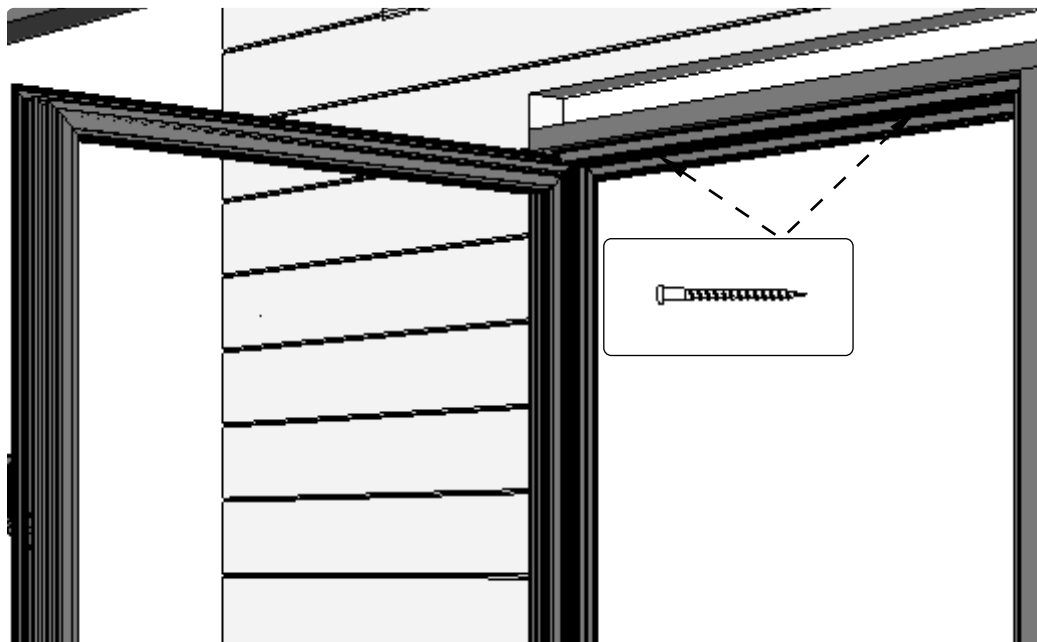
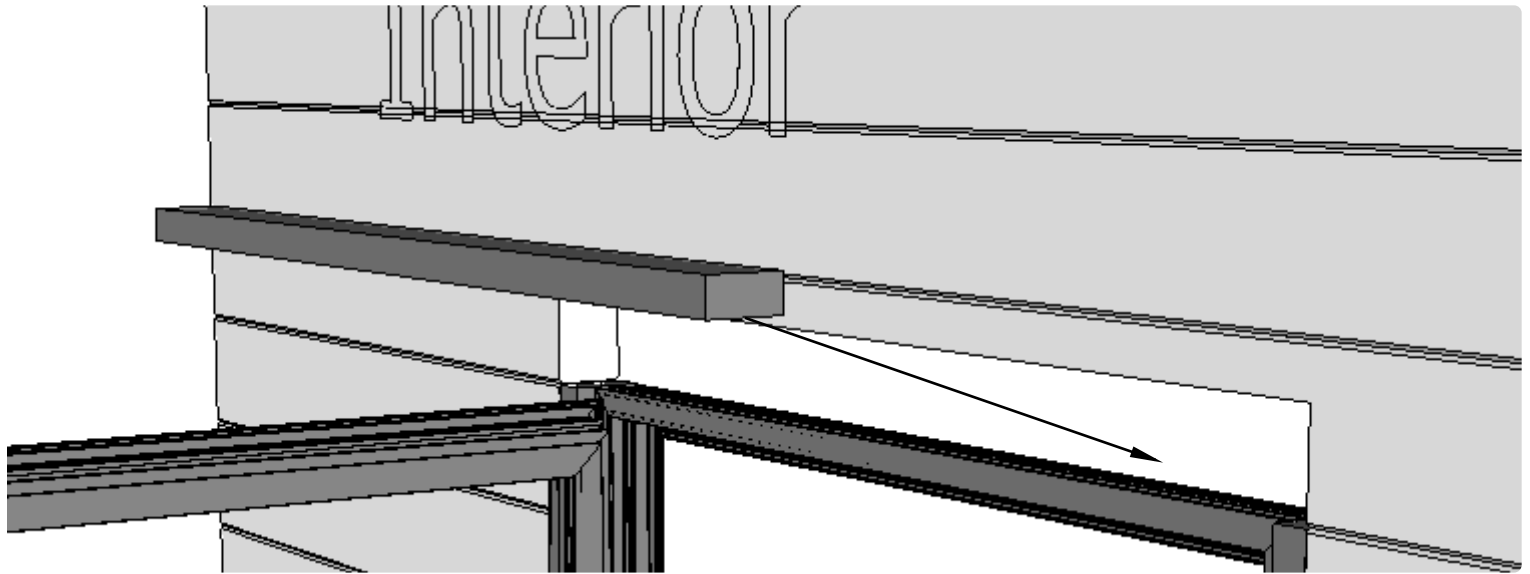

VI

Plan: 13
Positions:

QT140-1



Plan: 13

Positions:

COB

QKRPP3-5x50Zn

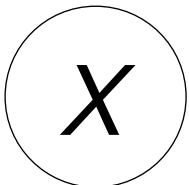
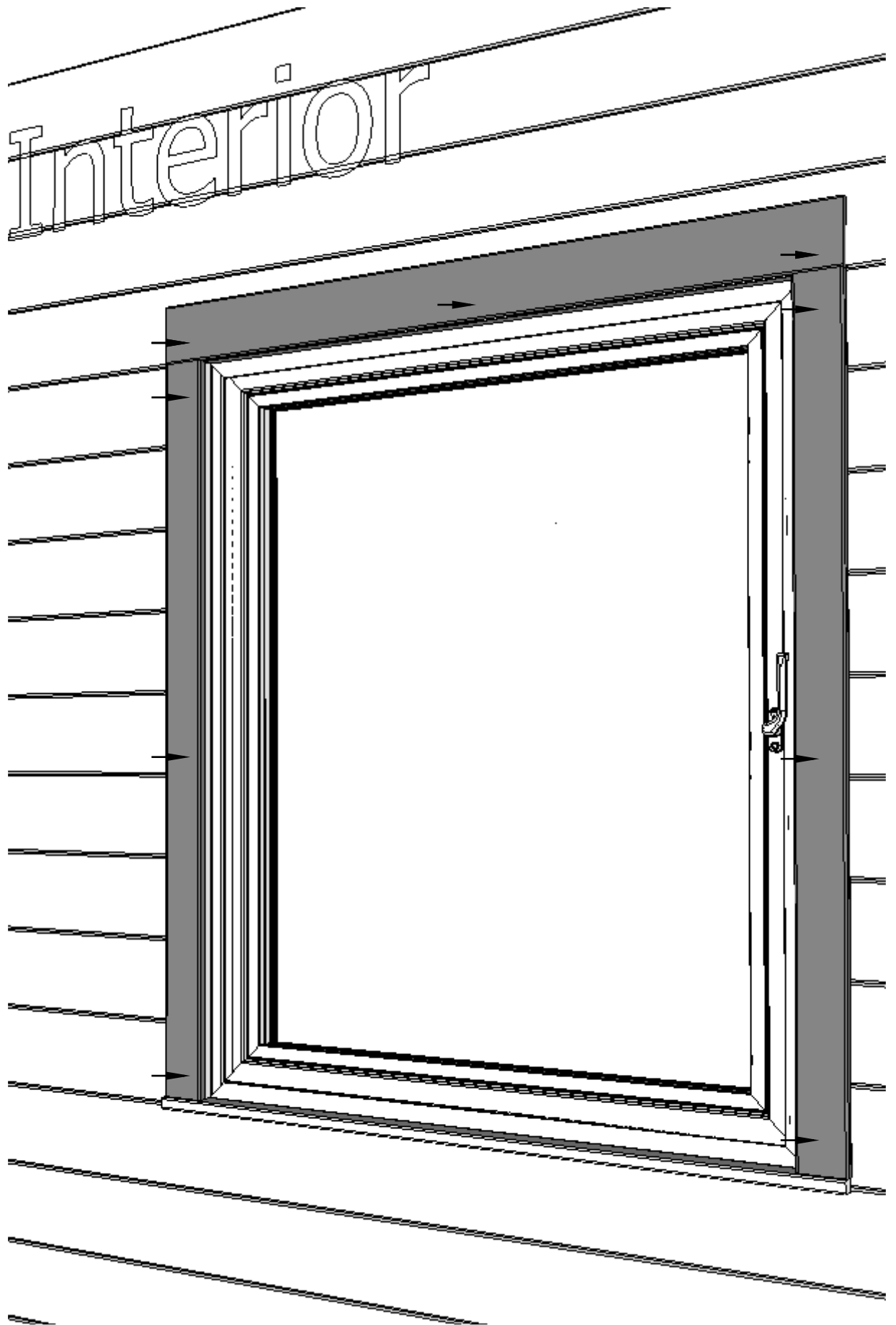

Plan: 13
Positions:

Exterior

3

2

1

1

Wind protective tape

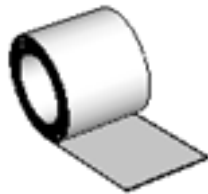

Not included

XI

Plan: 13

Positions:

COB

QKRPP3-5x50Zn



Exterior

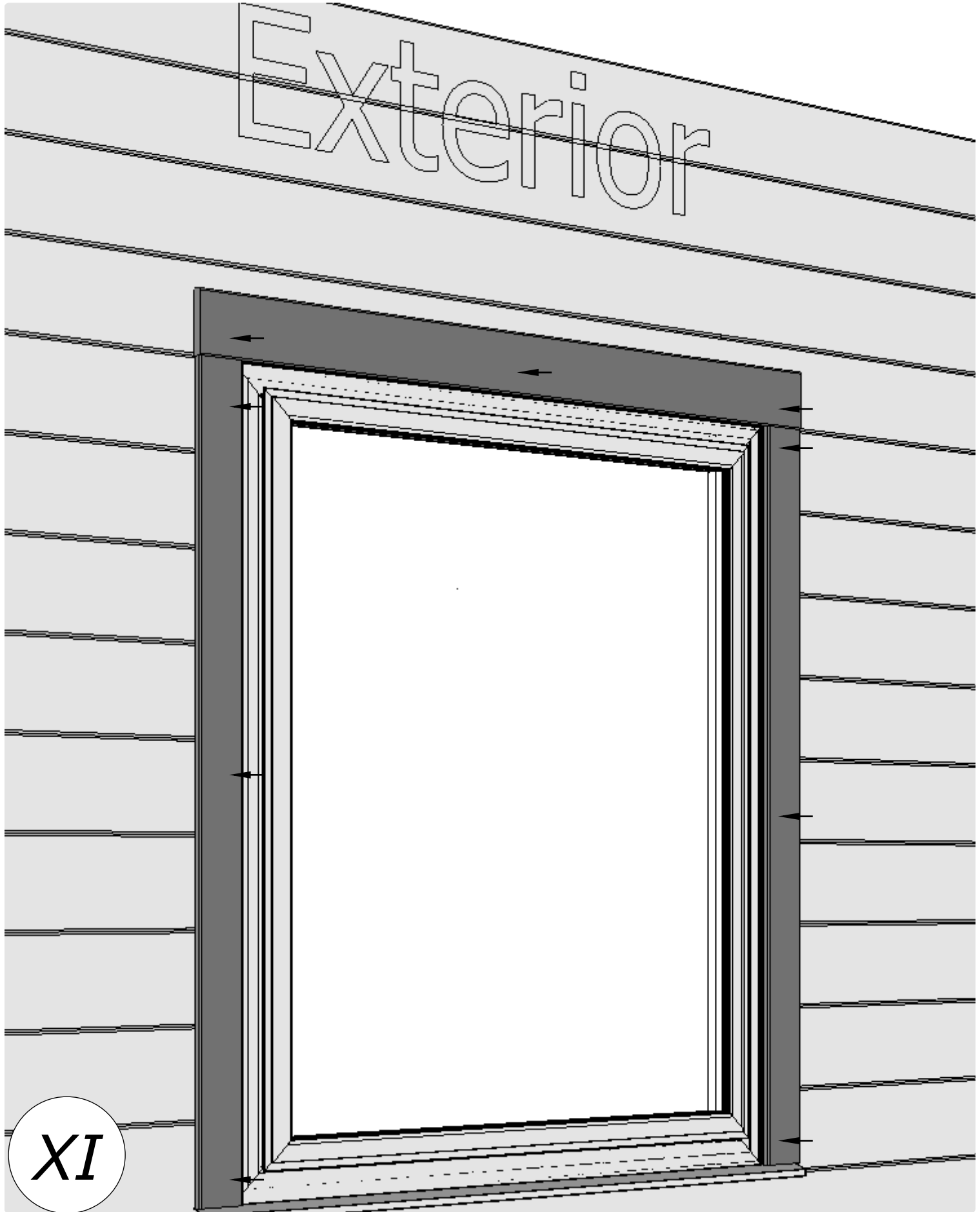

XI

Plan: 13

Positions:

COB

QKRPP3-5x50Zn

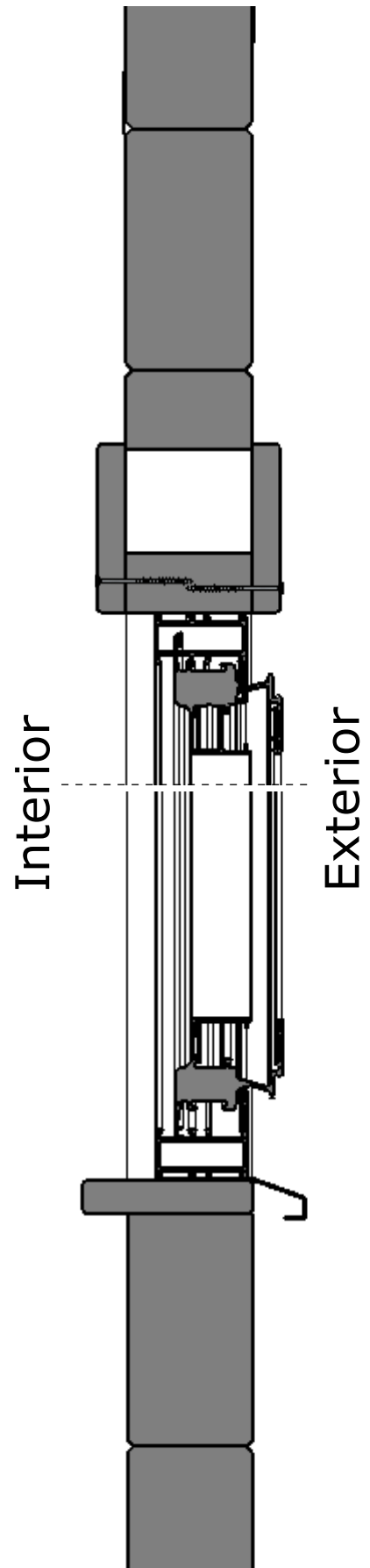
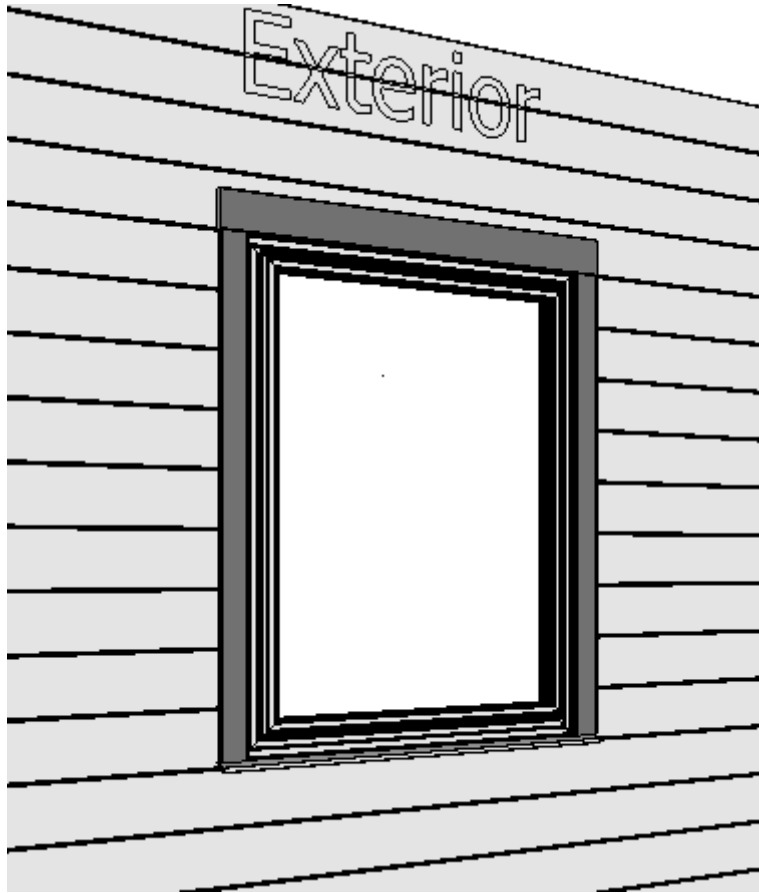

Interior

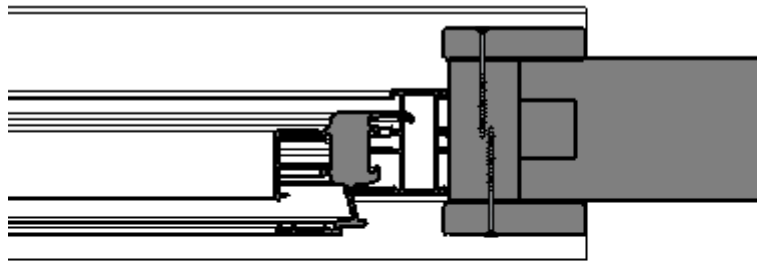

Exterior

