

303









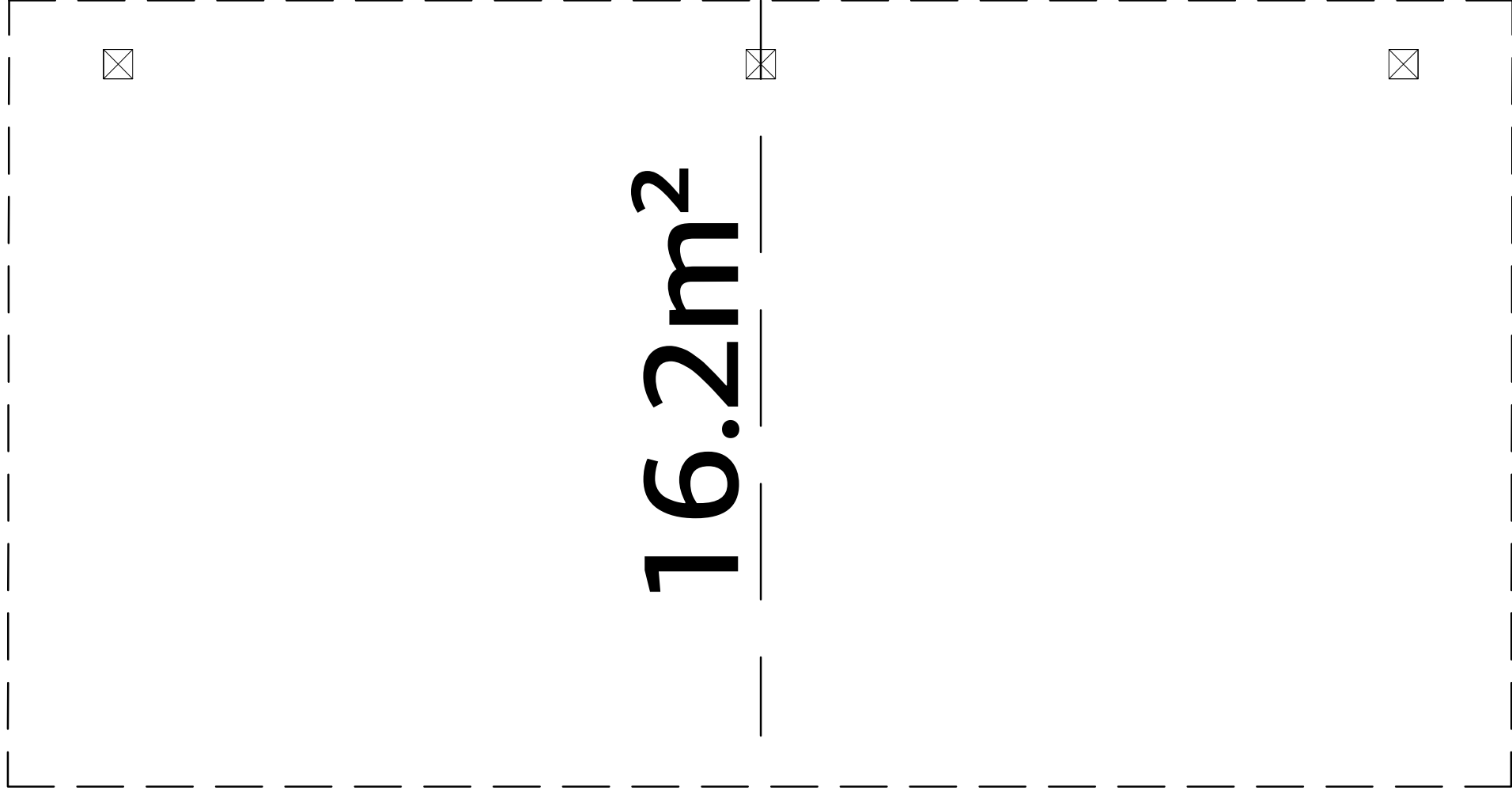

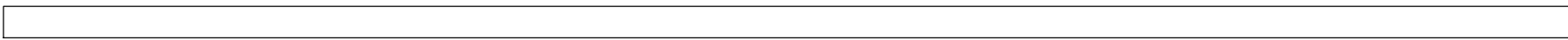
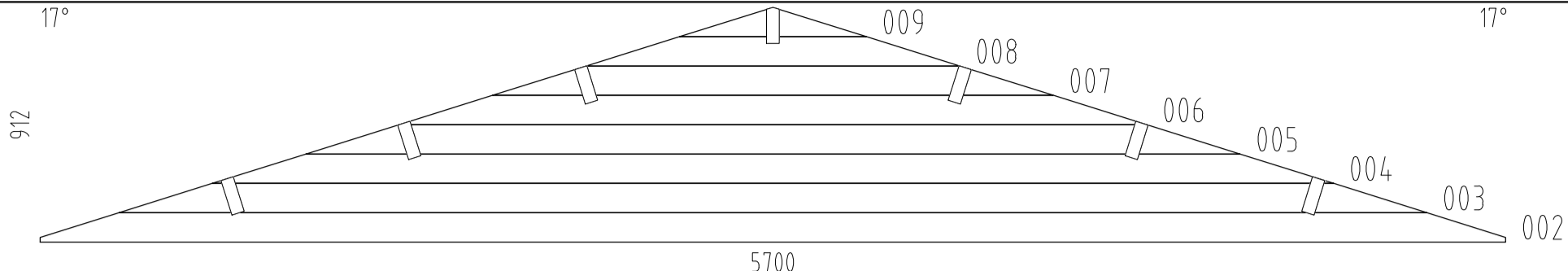









619

16.2m²

541

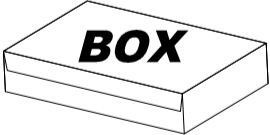
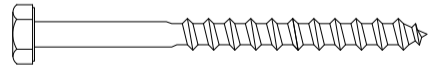
324

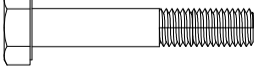
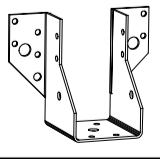

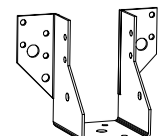
Pos	15.08.2024 SPECIFICATION-STÜCKLISTE-NOMENCLATURE-ELEMENTI-ESPECIFICACIÓN LA120-3054	1/2	Pcs	Profile (mm)	Length (mm)
001			1	44x114	5700
WA-1			1		
Det1	Detail - Detail - Detail - Dettaglio - Detalle 		2	95x44	870
Pst1	Post - Pfosten - Poteau - Montante - Poste 		1	120x120	2272
Pst2	Post - Pfosten - Poteau - Montante - Poste 		1	120x120	2272
Pst3	Post - Pfosten - Poteau - Montante - Poste 		1	120x120	2272
SP1	Support brace - Stützleiste - Baguette de support - Listello di supporto - Listón de soporte 		1	90x90	800
SP2	Support brace - Stützleiste - Baguette de support - Listello di supporto - Listón de soporte 		1	90x90	800
SP3	Support brace - Stützleiste - Baguette de support - Listello di supporto - Listón de soporte 		1	90x90	800
SP4	Support brace - Stützleiste - Baguette de support - Listello di supporto - Listón de soporte 		1	90x90	800
TA1	TALA 		1	44x195	2990
TA2	TALA 		1	44x195	2990
PR1	Purlin - Dachpfette - Arbalétrier - Arcareccio - Correa 2990 200 		6	60x160	3234
PR2	Purlin - Dachpfette - Arbalétrier - Arcareccio - Correa 3012 200 		1	60x160	3256
RB2-1	Roof board - Dachbrett - Madrier du toit - Tavola tetto - Tabla de tejado 		70	89x19	3200
EaE1-1	Eave edging - Dachrandbrett - Madrier en bordure du toit - Tavola bordo tetto - Tabla de valadizo 		2	16x95	3034
RE2-1	Roof edge reinforcement - Dachrandleiste - Baguette en bordure du toit - Rinforzo bordo tetto - Refuerzo borde tejado 		2	32x40	3034
Fim	-Fixing kit - Befestigungsset - Moyens de fixation - Materiale di fissaggio - Kit de fijación 		1		
QKRKK8x120Zn	Bolt - Schloss-schraube - Boulon - Bullone - Perno - 8x120mm KSKR 		4	SPx	
QPOKK12x120Zn	Bolt - Schloss-schraube - Boulon - Bullone - Perno - M12x120mm KSP0 		6	Wall+TA1	
QPOKK12x140Zn	Bolt - Schloss-schraube - Boulon - Bullone - Perno - M12x140mm KSP0 		18	PR1+PRx	
QPOKK12x70Zn	Bolt - Schloss-schraube - Boulon - Bullone - Perno - M12x70mm KSP0 		2		
QKA20	Hole plug - Abdeckkappe - Cache-vis - Tappi in legno - Embellecedor - QKA20 		4	SPx	
QT60x100Zn	Joist hanger - Balkenschuhe - Étrier a solive - Gancio travetto - Suspensión de la viga - QT60x100Zn 		2	PR2	

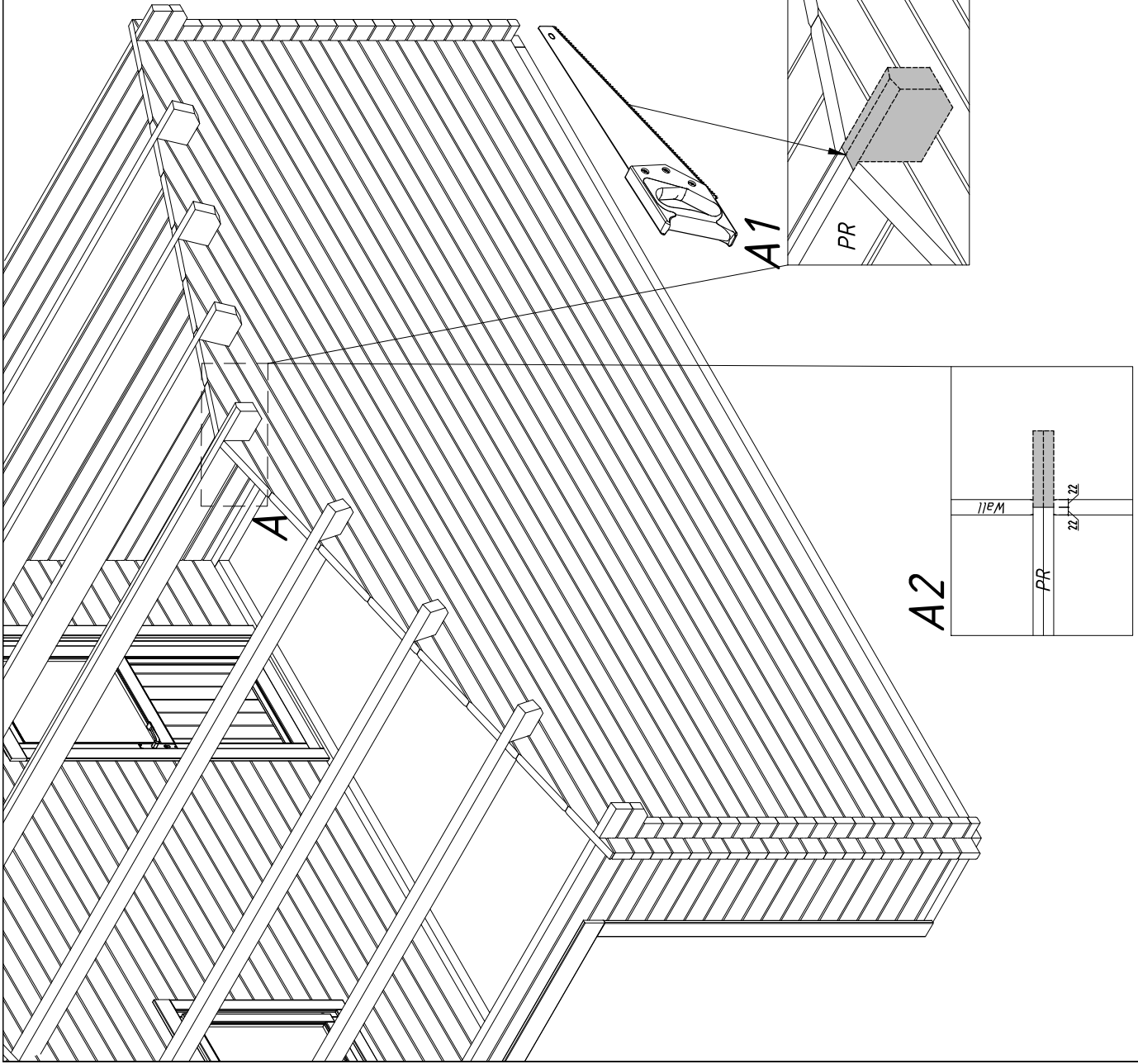

LA120-3054

* Cut if needed

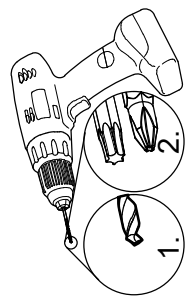
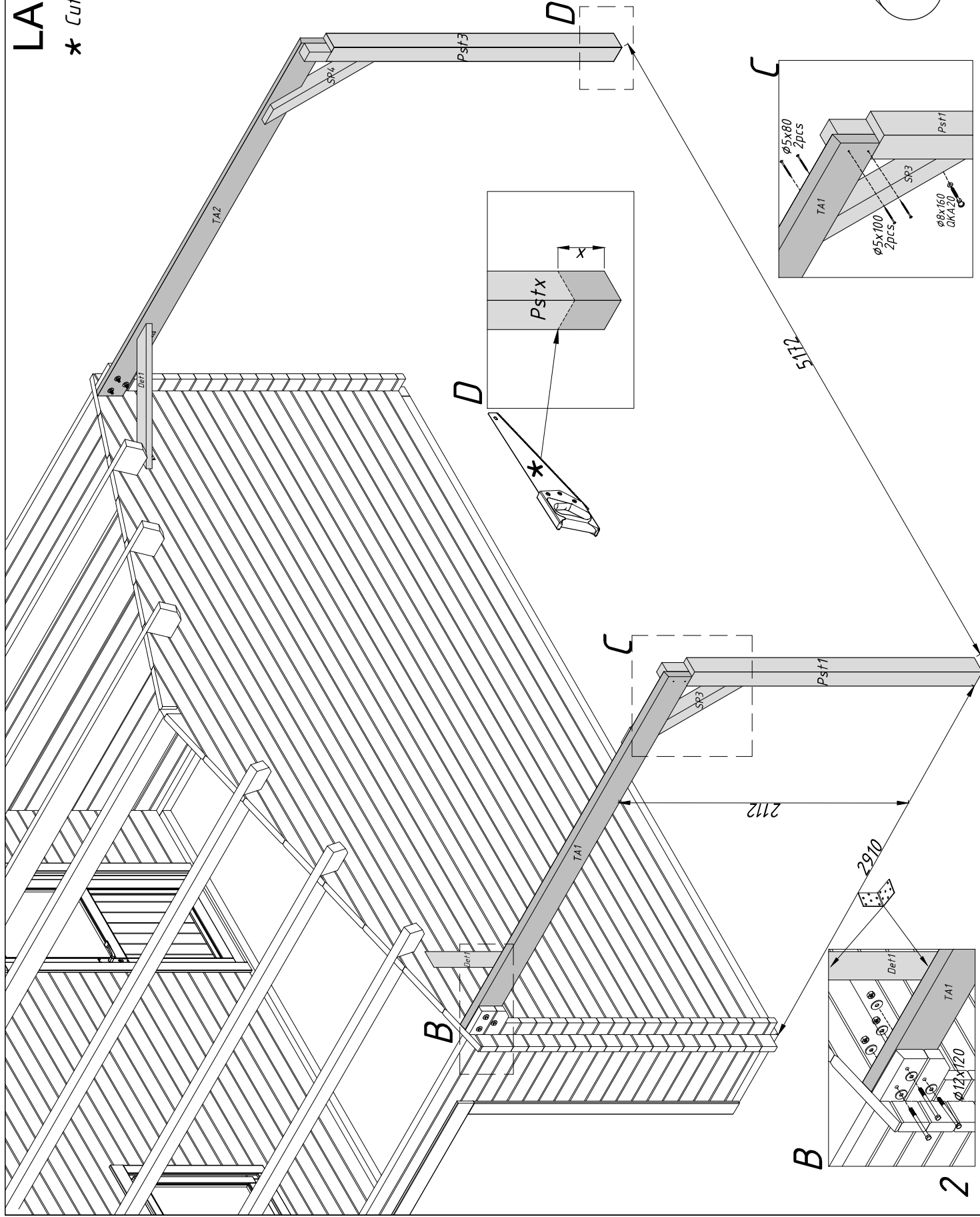

LA120-3054

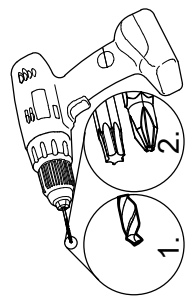
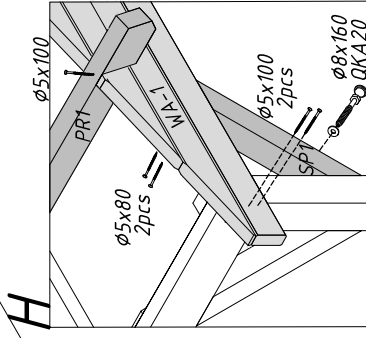
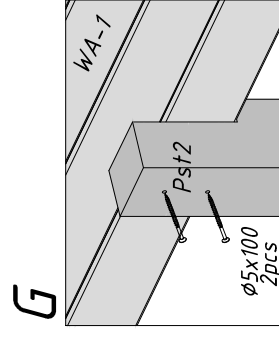
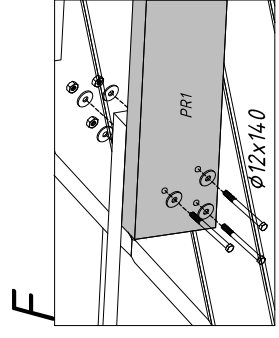
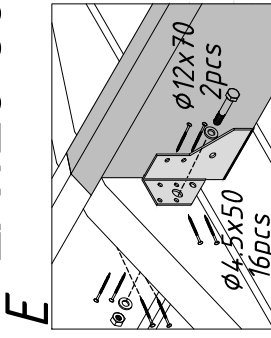
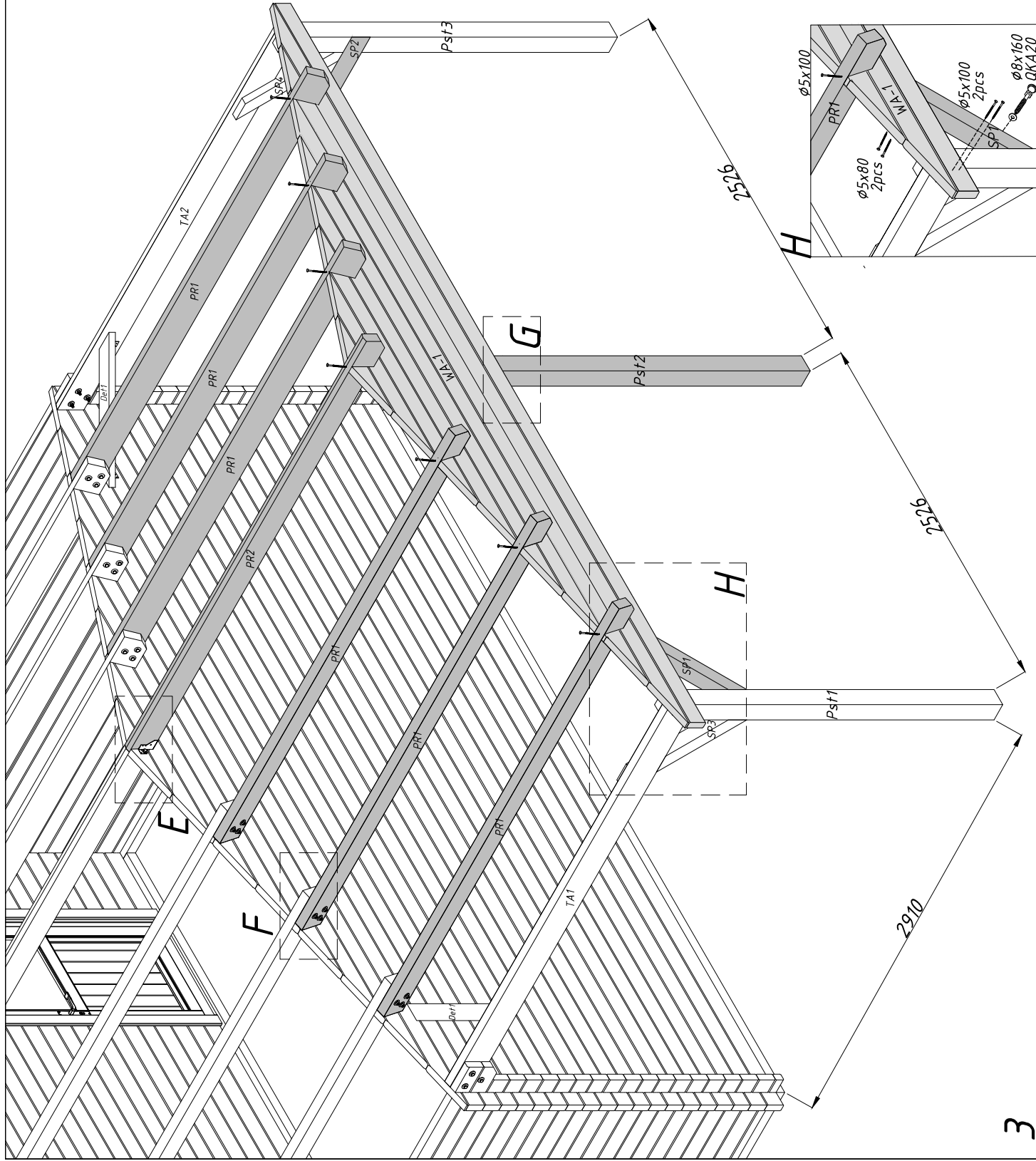

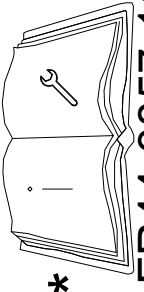
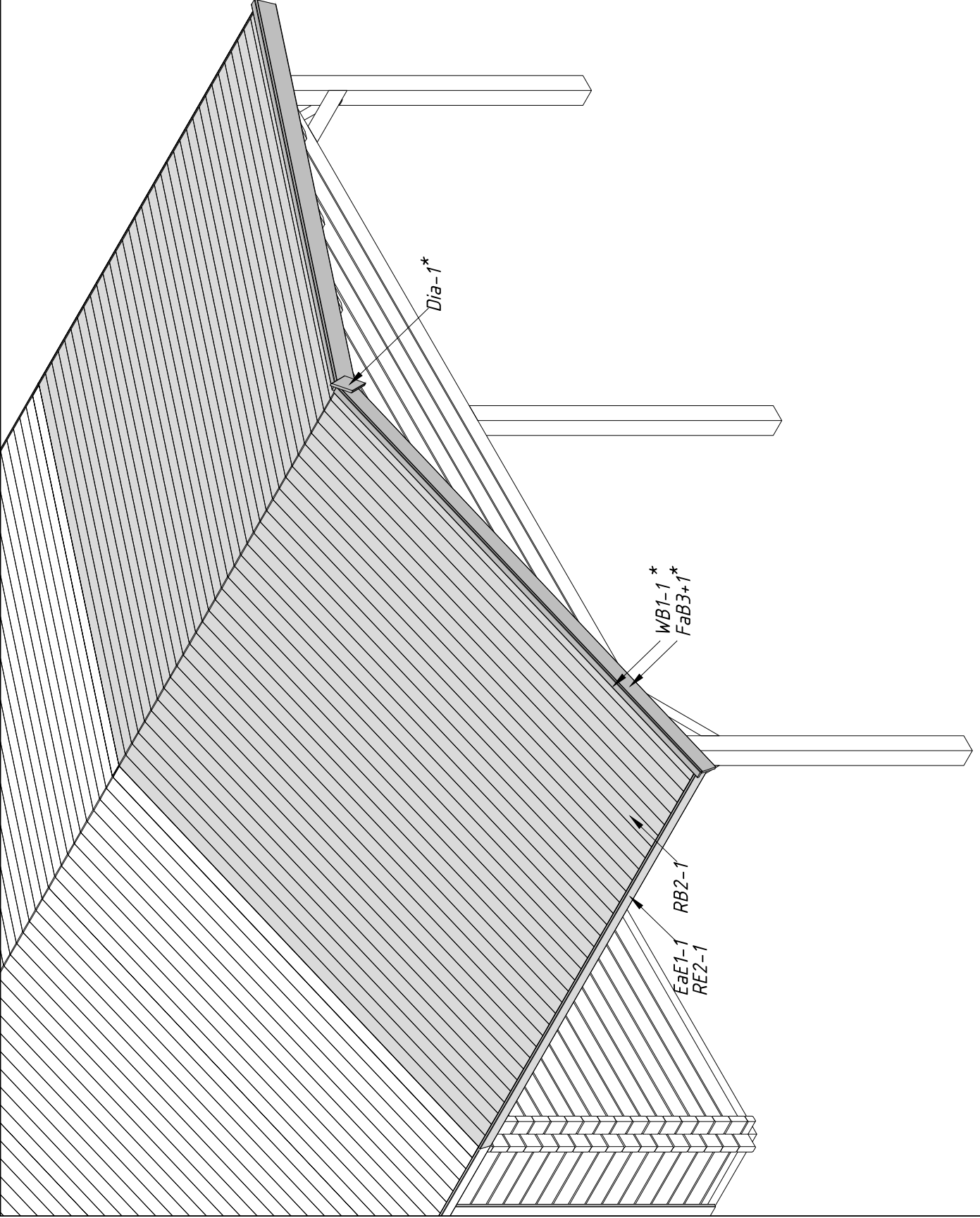

*