

210 102

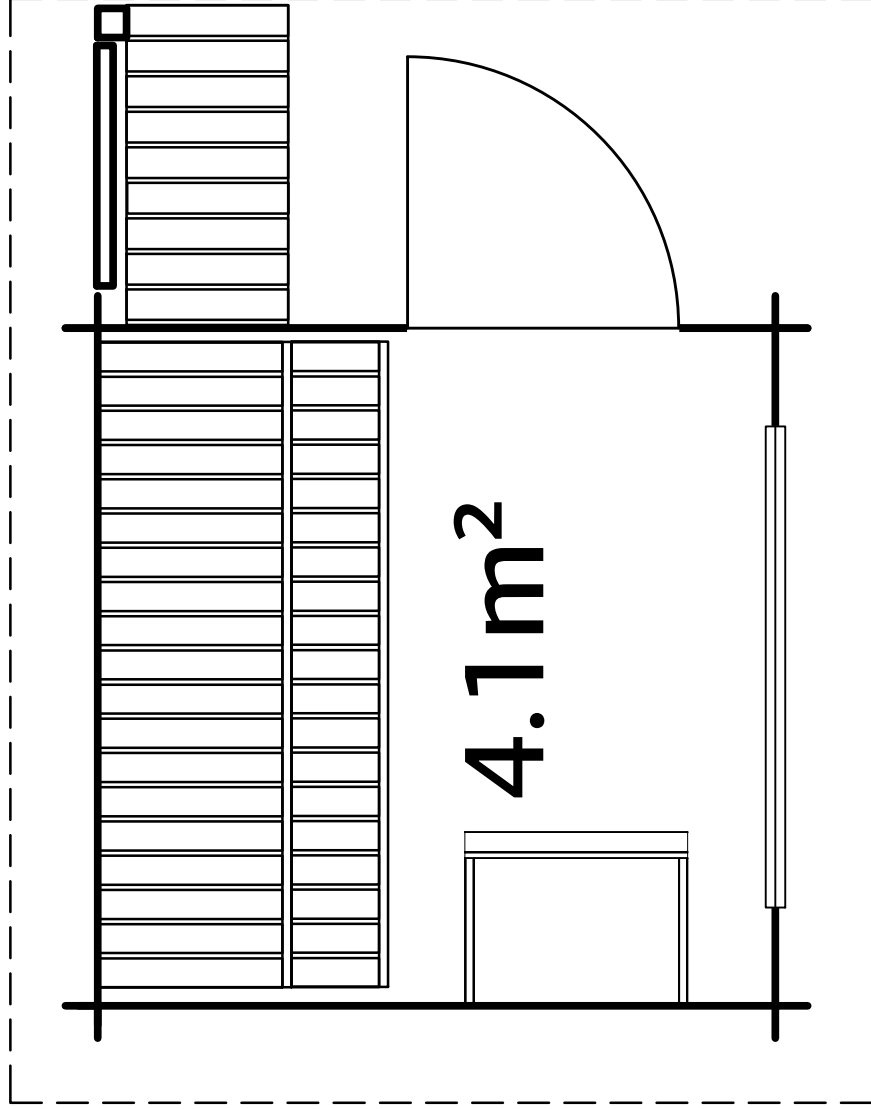









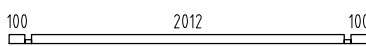

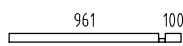

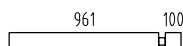
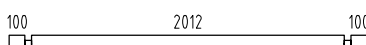

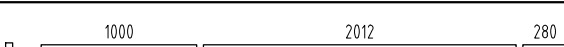

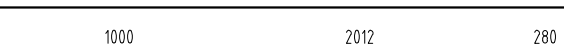

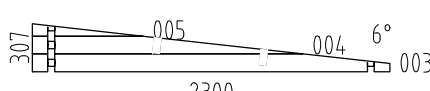
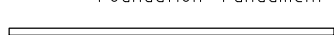
210

267

4.1m²





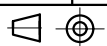



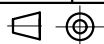

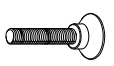
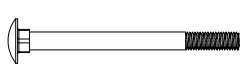
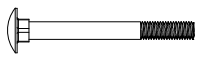
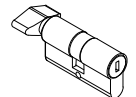
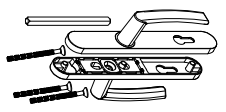
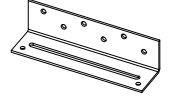



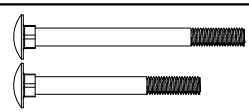

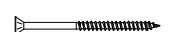

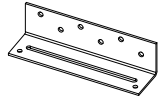

342

Pos	SPECIFICATION-STÜCKLISTE-NOMENCLATURE-ELEMENTI-ESPECIFICACIÓN FR44-2323	Pcs	Profile (mm)	Length (mm)
001		1	44x57	2300
002		45	44x114	2300
006		1	44x57	350
007		1	44x57	1105
008		17	44x114	350
009		17	44x114	1105
010		1	44x114	2300
011		18	44x114	400
012		1	44x114	3180
013		1	44x120	3380
014		1	44x114	2380
015		1	44x120	3380
W1-1		1		
W2-1		1		
AR1	Foundation- Fundament- Fondation- Fondazione- Vigas de cimentación 	2	70x45	2090
AR2	Foundation- Fundament- Fondation- Fondazione- Vigas de cimentación 	5	70x45	1950
FB1	Floor board- Fussbodenbrett- Madrier du plancher - Tavola pavimento- Tabla de suelo 	17	120x28	2006
CnB1	Connecting board- Verbindungsbrett- Madrier de connection- Tavola di collegamento- Listón de juntura 	1	90x28	690
CoB1	Covering board- Deckbrett- Madrier de couverture- Tavola di copertura- Listón de cubierta 	1	28x90	500
Pst1	Post- Pfosten- Poteau- Montante- Poste 	1	45x70	405
Pst2	Post- Pfosten- Poteau- Montante- Poste 	1	90x90	2120
Sla1	Slat- Leiste- Baguette- Listello- Listón 	6	19x19	2010
Sla3	Slat- Leiste- Baguette- Listello- Listón 	1	28x45	845

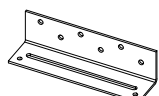

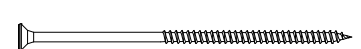

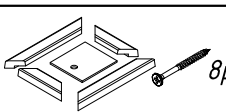
Pos	SPECIFICATION-STÜCKLISTE-NOMENCLATURE-ELEMENTI-ESPECIFICACIÓN FR44-2323	Pcs	Profile (mm)	Length (mm)
SP1	Support brace- Stützleiste- Baguette de support- Listello di supporto- Listón de soporte 	2	34x70	2010
SP2	Support brace- Stützleiste- Baguette de support- Listello di supporto- Listón de soporte 	1	58x40	470
SP3	Support brace- Stützleiste- Baguette de support- Listello di supporto- Listón de soporte 	2	58x40	370
SP4	Support brace- Stützleiste- Baguette de support- Listello di supporto- Listón de soporte 	2	58x40	570
SP5	Support brace- Stützleiste- Baguette de support- Listello di supporto- Listón de soporte 	2	45x25	510
SP6	Support brace- Stützleiste- Baguette de support- Listello di supporto- Listón de soporte 	2	45x25	390
SP7	Support brace- Stützleiste- Baguette de support- Listello di supporto- Listón de soporte 	2	45x25	370
PR1	Purlin- Dachpfette- Arbalétrier- Arcareccio- Correa 	2	44x120	3380
RB2-1	Roof board- Dachbrett- Madrier du toit- Tavola tetto- Tabla de tejado 	38	89x19	2640
CB1-1	Ceiling board- Dachbodenbrett- Madrier du Grenier- Tavola soffitta- Tabla de techo 	23	89x16	2006
CeS1-1	Ceiling slat- Deckenleiste- Baguette du plafond- Listello tetto- Listón de techo 19x19 	4	19x19	2040
EaE6-1	Eave edging- Dachrandbrett- Madrier en bordure du toit- Tavola bordo tetto- Tabla de valadizo 	2	19x120	2740
EaE6-2	Eave edging- Dachrandbrett- Madrier en bordure du toit- Tavola bordo tetto- Tabla de valadizo 	2	19x120	3480
FIB2-1	Floor beading- Fussbodenleiste- Baguette du plancher- Listello pavimento- Listón de suelo 	4	19x19	2040
RE2-1	Roof edge reinforcement- Dachrandleiste- Baguette en bordure du toit- Rinforzo bordo tetto- Refuerzo borde tejado 	2	32x40	3380
Sis1-1	Side slat- Randleiste- Baguette en bordure- Listón de borde- Listello bordo 	4	19x70	1150
Sis1-2	Side slat- Randleiste- Baguette en bordure- Listón de borde- Listello bordo 	1	19x70	1600
Sis1-3	Side slat- Randleiste- Baguette en bordure- Listón de borde- Listello bordo 	4	19x70	2050
Sis2-1	Side slat- Randleiste- Baguette en bordure- Listón de borde- Listello bordo 	2	19x95	1050
Sis2-2	Side slat- Randleiste- Baguette en bordure- Listón de borde- Listello bordo 	3	19x95	1750
StB1-1	Storm brace- Sturmleiste- Protection contre le vent- Antivento- Protector contra tormentas 	2	25x45	2060
StB1-2	Storm brace- Sturmleiste- Protection contre le vent- Antivento- Protector contra tormentas 	2	25x45	2250
WB1-1	Wind brace- Windbrett- Madrier contre le vent- Tavola vento- Tabla contra el viento 	2	16x45	2740

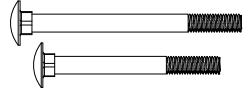

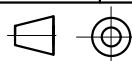
Pos	SPECIFICATION-STÜCKLISTE-NOMENCLATURE-ELEMENTI-ESPECIFICACIÓN FR44-2323	Pcs	Profile (mm)	Length (mm)
Fim	-Fixing kit- Befestigungsset- Moyens de fixation- Materiale di fissaggio- Kit de fijación	1	USE	
QLA16	Adjustment bolt - Senkbolzen - Boulon de réglage - Bullone di regolamento- Perno de ajuste 	1	Pst2	
QRT30 x10x50	Adjustment bolt - Senkbolzen - Boulon de réglage - Bullone di regolamento- Perno de ajuste 30xM10x50 	1	Pst1	
QPOYP8 x100Zn	Bolt -Schloss-schraube -Boulon- Bullone- Perno- M8x100mm PUP0 	1	Pst2	
QPOYP 8x80Zn	Bolt -Schloss-schraube -Boulon- Bullone- Perno- M8x80mm PUP0 	9	StB1-1 StB1-2	
QULS13 0x40-2	Cylinder - Zylinderschloss- Serrure a mortaiser- Serratura a cilindro- Bombin- 30.40-2 	1	U44-100P	
QLIU3 5x92Hb	Door fittings- Türbeschlag- Ferrure- Ferramenta porta- Manilla (puerta)- QLIU35x92Hb 	1	U44-100P	
QNU35x3 5x130Zn	L-iron- Winkel- Angle -Angolo- Angulo 35x35x130 EM VN353590 	3	Louvre	
QNA1 4x40Me	Nail- Nagel- Clou- Chiodo- Clavo- 1.4x40mm 	100		
QNA2 2x50Zn	Nail- Nagel- Clou- Chiodo- Clavo- 2.5x50mm 	170	RB2-1 CB1-1	
QMUk K8Zn	Nut- Schraubenmutter- Écrou- Dado- Tuerca- M8mm 	9		
QKRPP3 _5x40Zn	Screw- Schraube- Vis- Vite- Tornillo- 3.5x40mm 	36	Sl1	
QKRPP 4_2x6 5HATX	Screw- Schraube- Vis- Vite- Tornillo- 4.2x65mm 	170	FB1 ; FB2	
QKRPP4 _5x50Zn	Screw- Schraube- Vis- Vite- Tornillo- 4.5x50mm 	166	EaE6-x;WB1-x;RE2-x EL3; Sisx-x	
QKRPP4 _5x60Zn	Screw- Schraube- Vis- Vite- Tornillo- 4.5x60mm 	2	CoB1	
QKRPP4 _5x70Zn	Screw- Schraube- Vis- Vite- Tornillo- 4.5x70mm 	50	 SP2; SP3;SP4 001;007;006 013; 015; SP6;SP7	
QKRPP 4x16Zn	Screw- Schraube- Vis- Vite- Tornillo- 4x16mm 	18		
QKRYP5 x40ZnTX	Screw- Schraube- Vis- Vite- Tornillo- 5x40mm 	3		
QKRPP5 x80ZnTX	Screw- Schraube- Vis- Vite- Tornillo- 5x80mm 	20	SP2;SP3;SP4 EL1a ; EL1b	
QKRPP 5x90Zn	Screw- Schraube- Vis- Vite- Tornillo- 5x90mm 	33	Wx-1 ; PR1x CnB1	
QKRPP6 x150Zn	Screw- Schraube- Vis- Vite- Tornillo- 6x150mm 	10	AR2	
QKA100 x100Zn	Ventilation grate- Lüftungsdeckel- Couvercle d'aération- Copertura aerazione- Embellecedor ventilación 	2	Wall1 ;WallB	
KE230	Ventilation hatch- Belüftungsluke- Trappe d'aération- Portello di ventilazione- Trampilla de ventilación KE230 	2	Wall1 ;WallB	8pcs
QSE8 x22Zn	Washer- Dichtscheibe- Joint- Rondella- Arandela- 8x22mm 	9		
MMPI30x 600x1200	Finnfoam FF-PIR 30 SAUNA 30x600x1200mm	8		

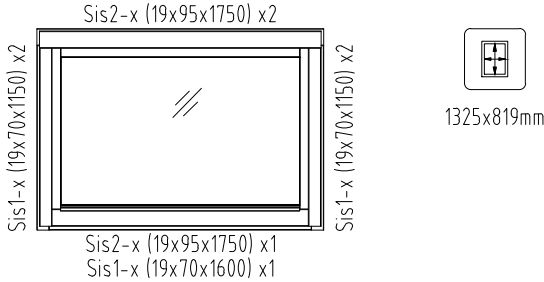
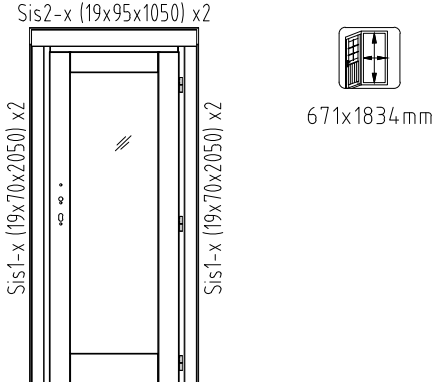
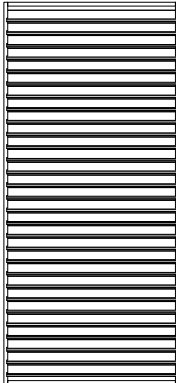
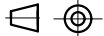

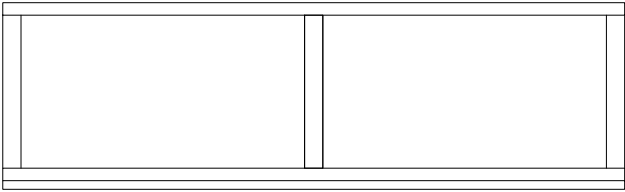
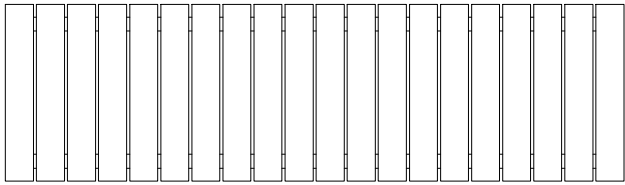
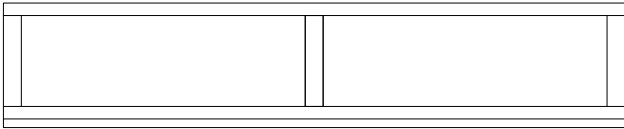
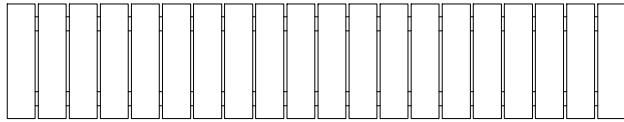
Pos	SPECIFICATION-STÜCKLISTE-NOMENCLATURE-ELEMENTI-ESPECIFICACIÓN FR44-2323	Pcs	Profile (mm)	Length (mm)
A44-108	<p>Window - Fenster - Fenetre - Finestra-Ventana 1490x990</p>  <p>Sis2-x (19x95x1750) x2 Sis1-x (19x70x1150) x2 1325x819mm Sis2-x (19x95x1750) x1 Sis1-x (19x70x1600) x1</p>	1		
U44-100P	<p>Door - Tür - Porte - Porta-Puerta 835x1936</p>  <p>Sis2-x (19x95x1050) x2 671x1834mm Sis1-x (19x70x2050) x2</p>	1		
	<p>Žaluzii-1-Louvre 810x1960</p> 	1		
	FR44-2323		Page	4/5

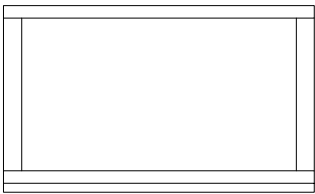
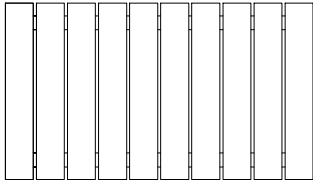
Pos	SPECIFICATION-STÜCKLISTE-NOMENCLATURE-ELEMENTI-ESPECIFICACIÓN FR44-2323	Pcs	Profile (mm)	Length (mm)
EL1a		1	600x90	2000
EL1b		1	568x47	1990
EL2a		1	400x90	2000
EL2b		1	368x47	1990
EL3		1	320x47	1900
EL4a		1	500x90	1000
EL4b		1	468x47	990

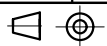

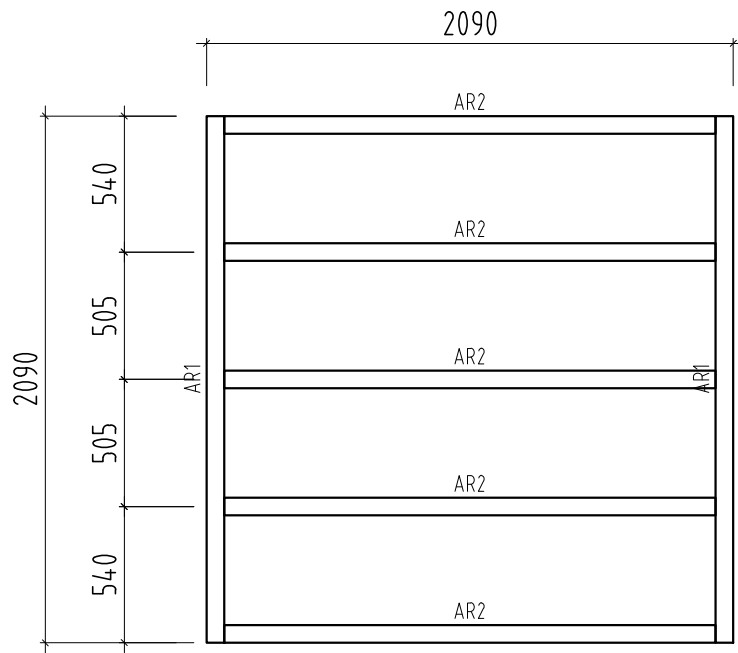

H = 1.700 m
TOTAL: 4.05 m²

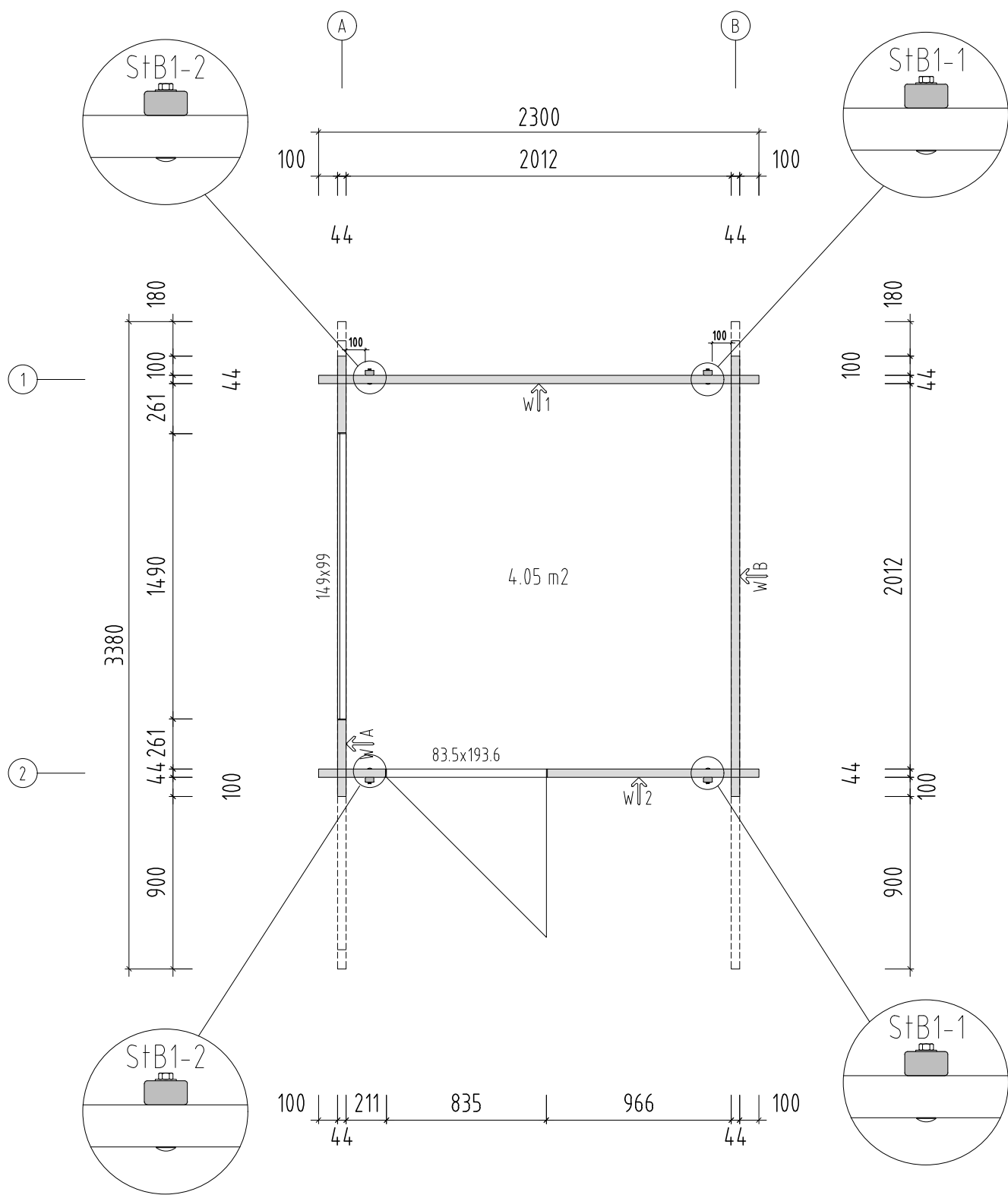

22
21
20
19
18
17
16
15
14
13
12
11
10
9
8
7
6
5
4
3
2
Wall 1

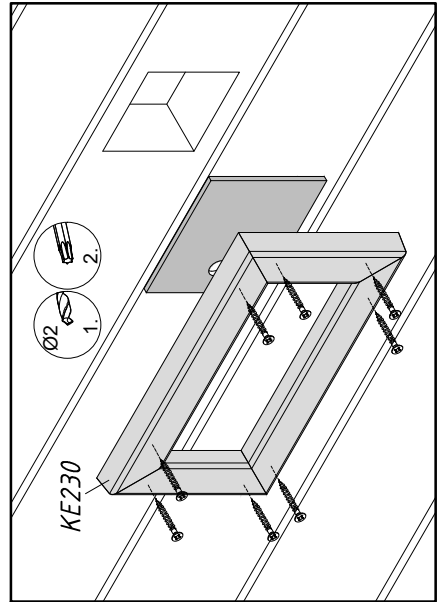
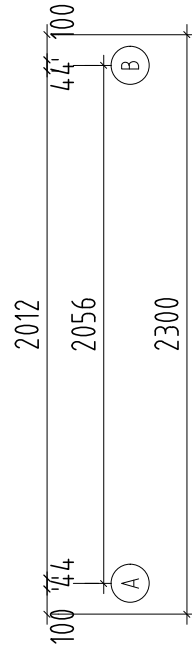
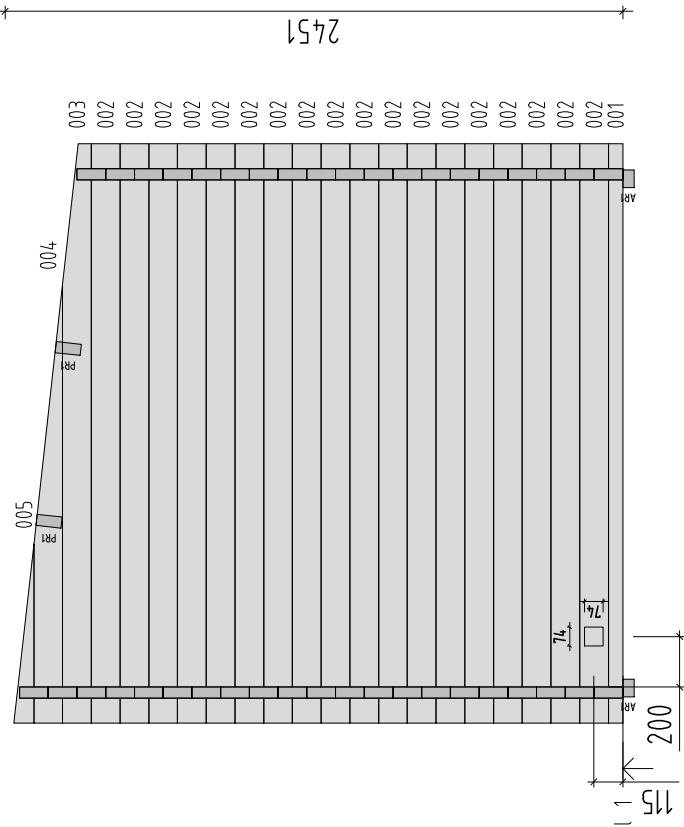

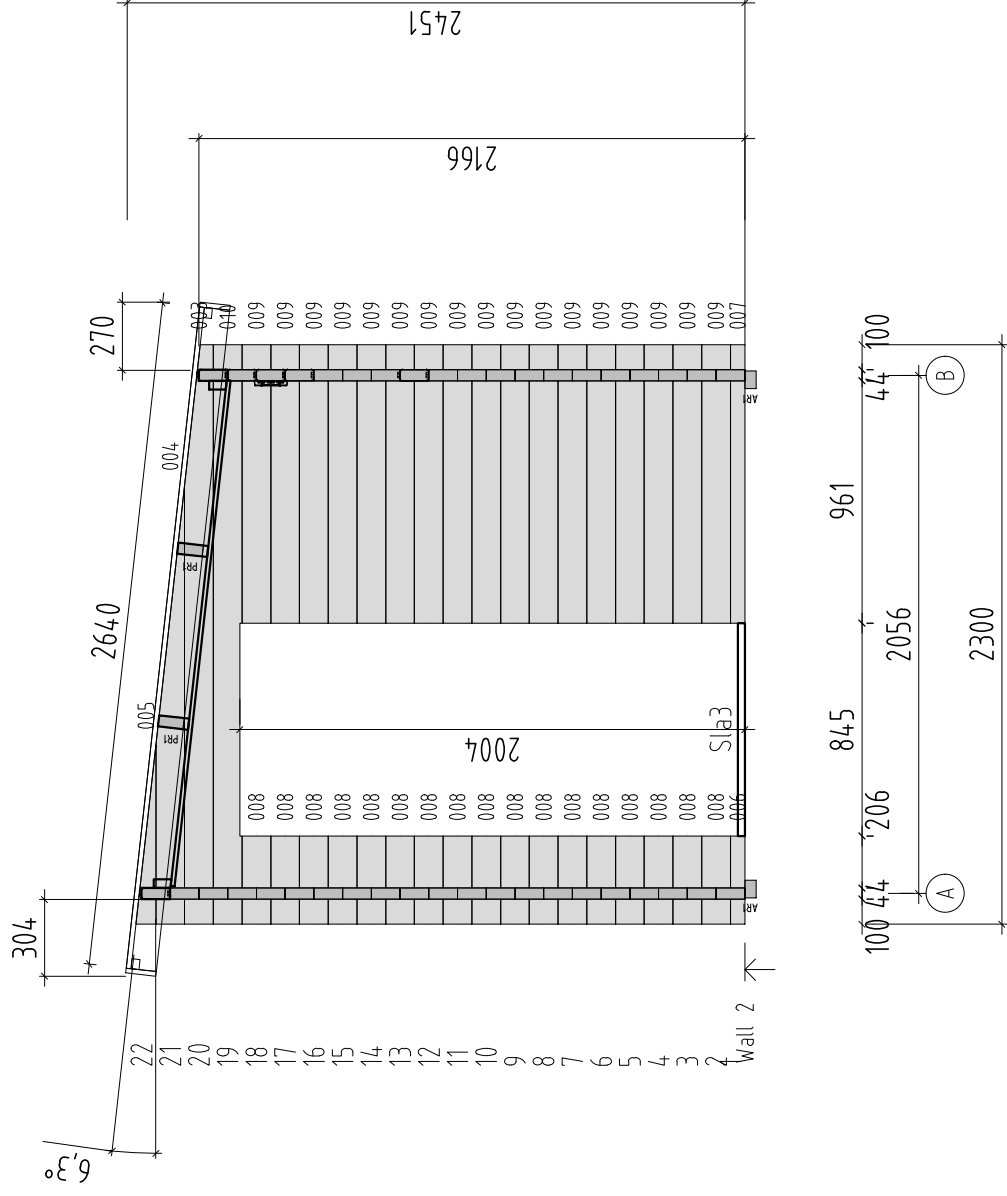

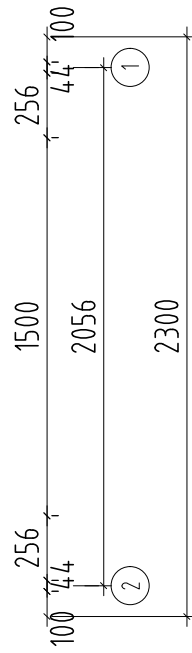
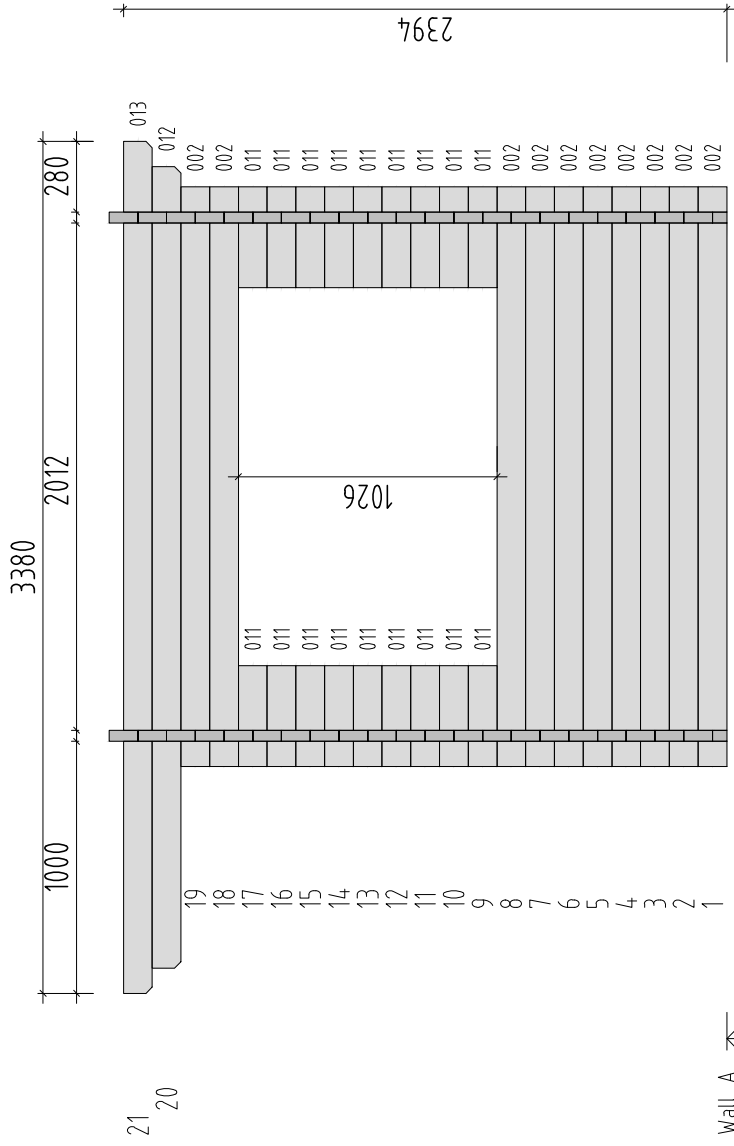

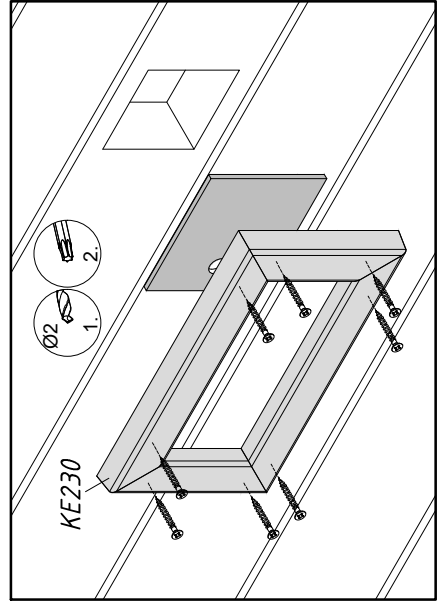
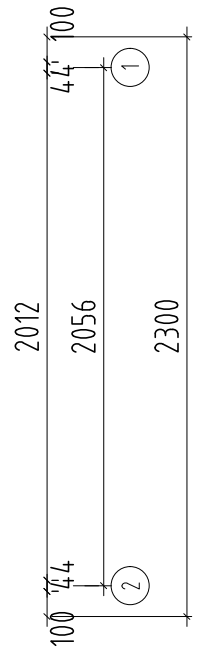
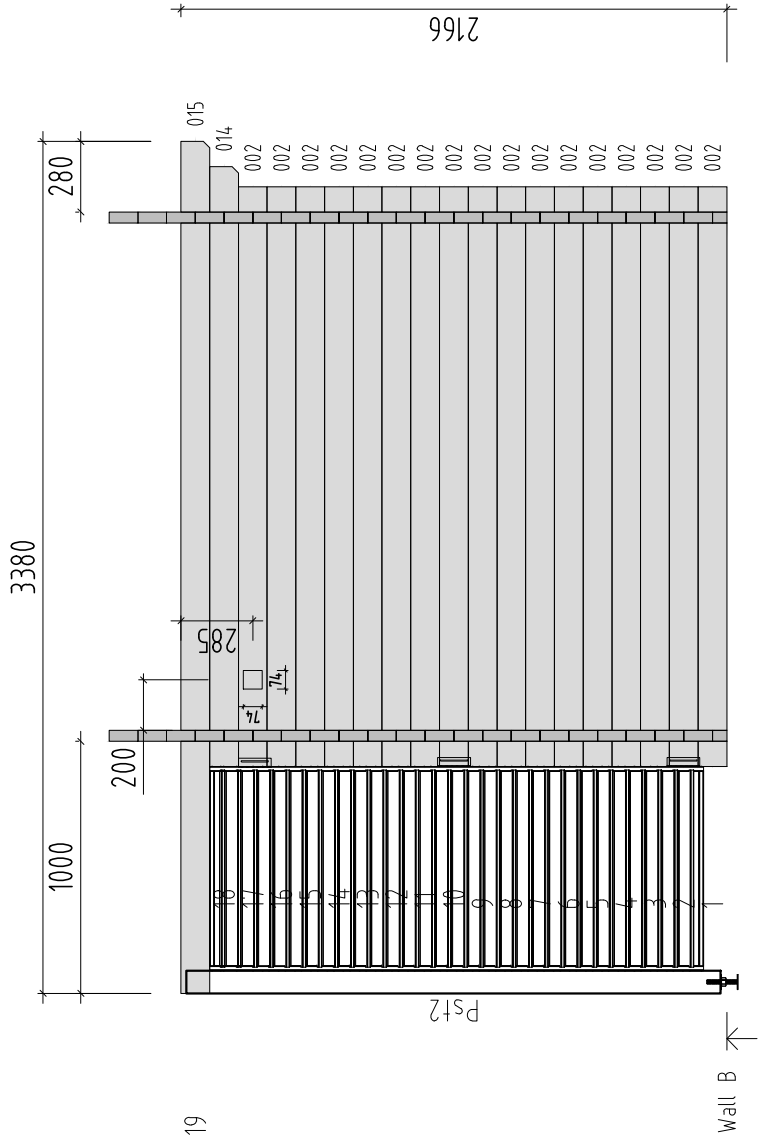

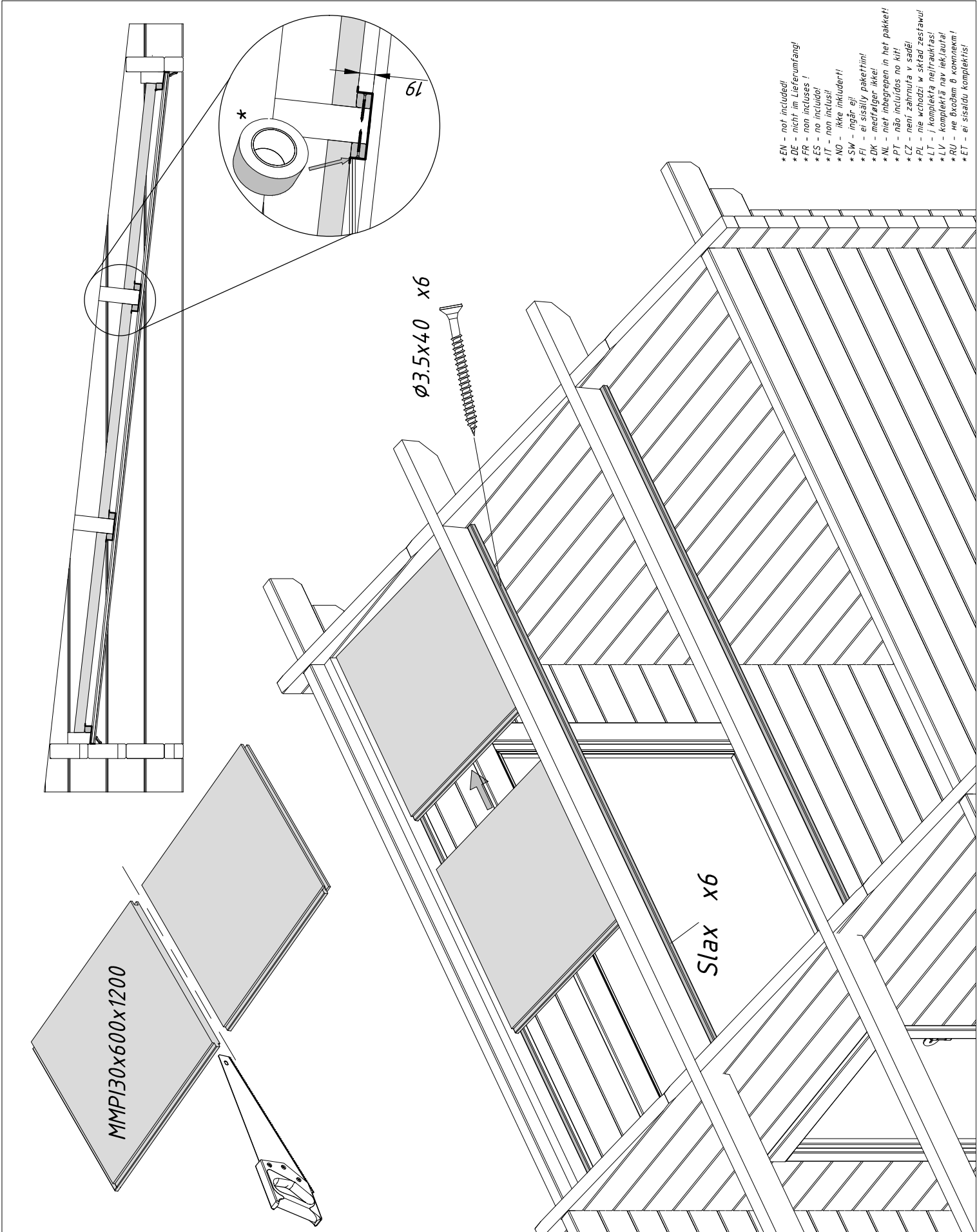

MMPI30x600x1200

Ø3.5x40 x6

Slax x6

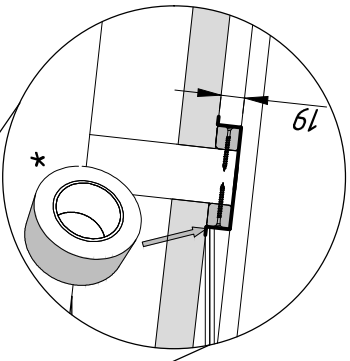

19

- *EN - not included!
- *DE - nicht im Lieferumfang!
- *FR - non inclusés !
- *ES - no included!
- *IT - non inclusi!
- *NO - ikke inkludert!
- *SW - ingår ej!
- *FI - ei sisälly pakettiin!
- *DK - medfølger ikke!
- *NL - niet inbegrepen in het pakket!
- *PT - não incluídos no kit!
- *CZ - není zahrnuta v sadbě!
- *PL - nie wchodzi w skład zestawu!
- *LT - į komplektą neįtrauktas!
- *LV - komplektā nav iekļauti!
- *RU - Не входит в комплект!
- *ET - ei sisaldu kompleksis!

