

250

414







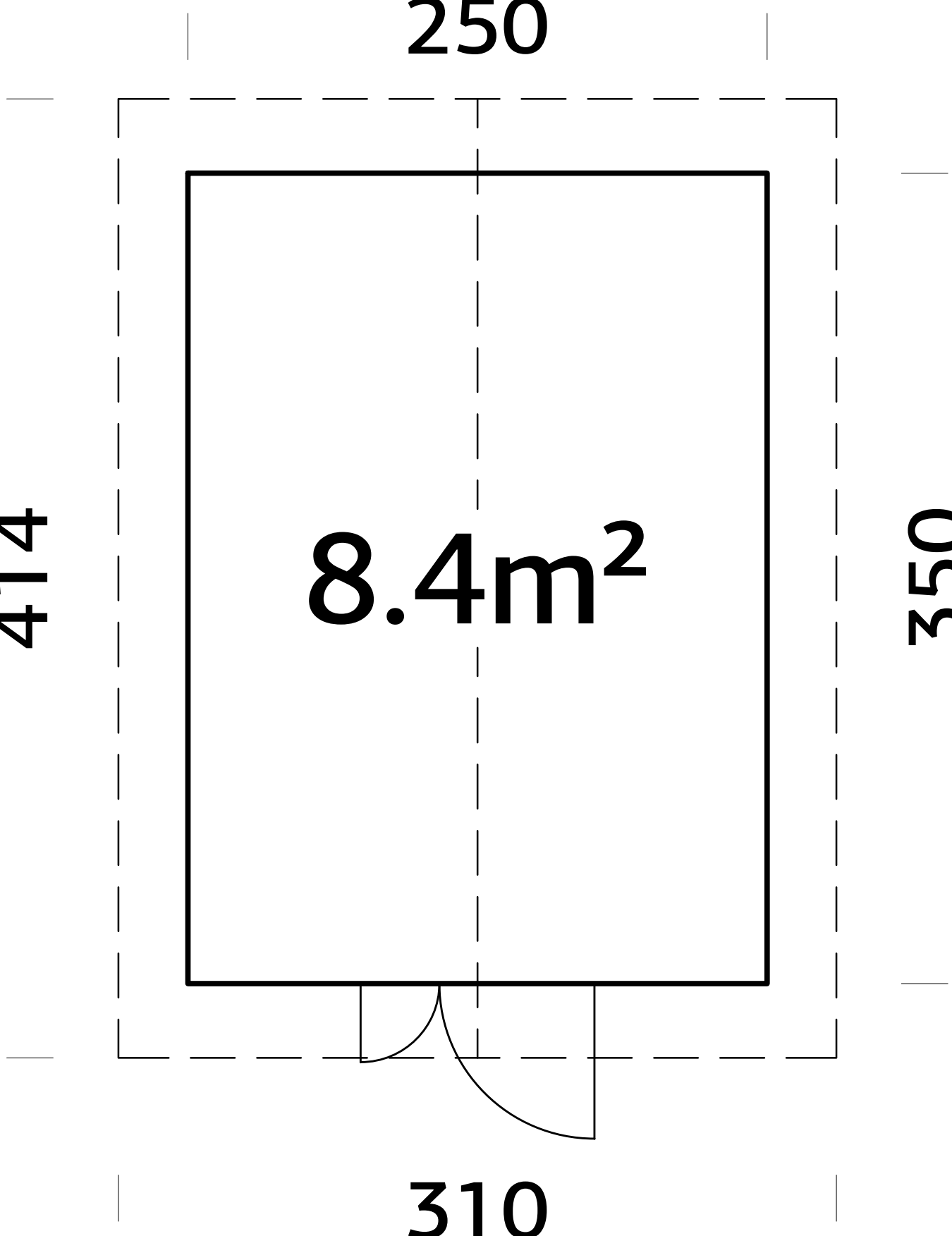

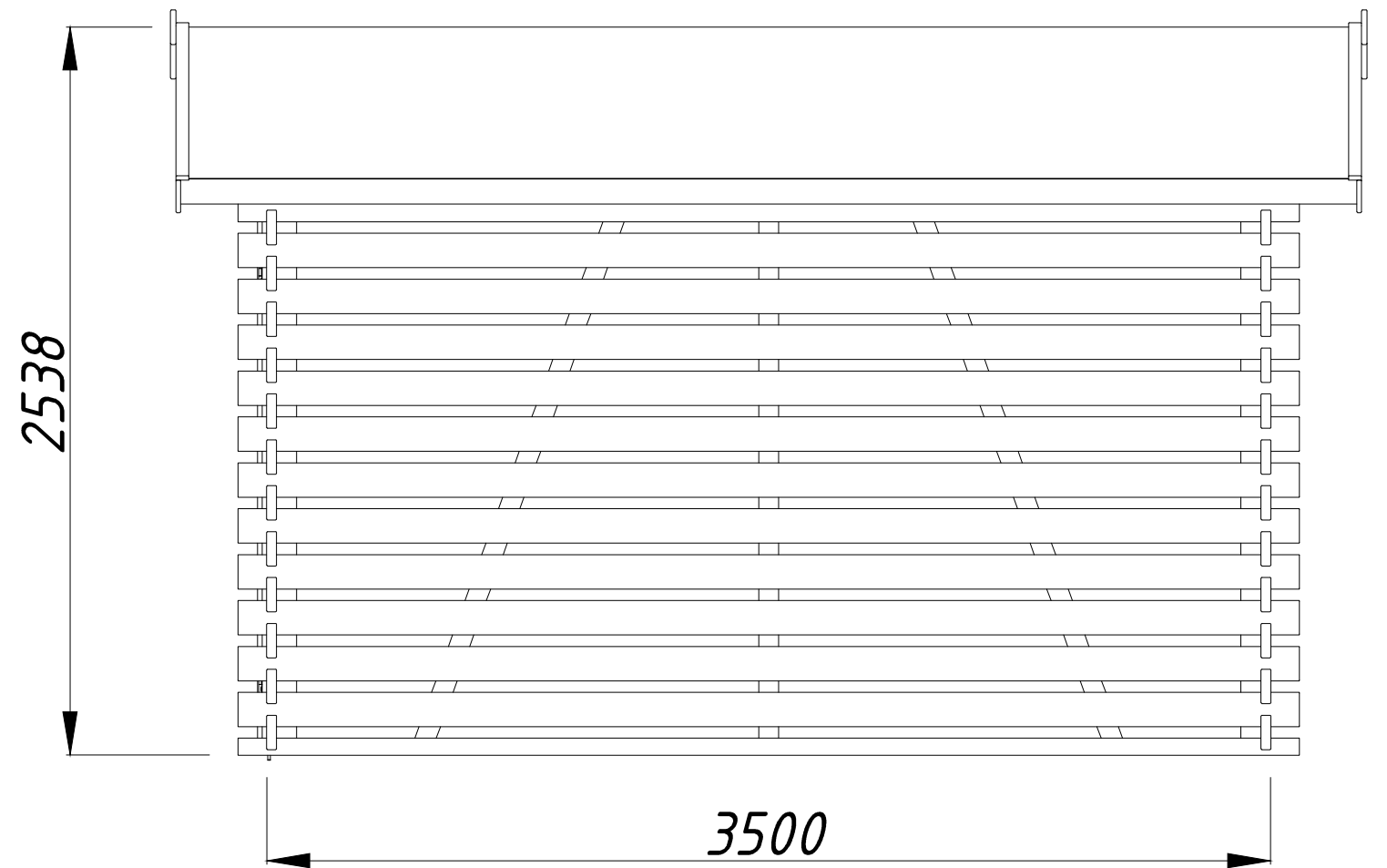
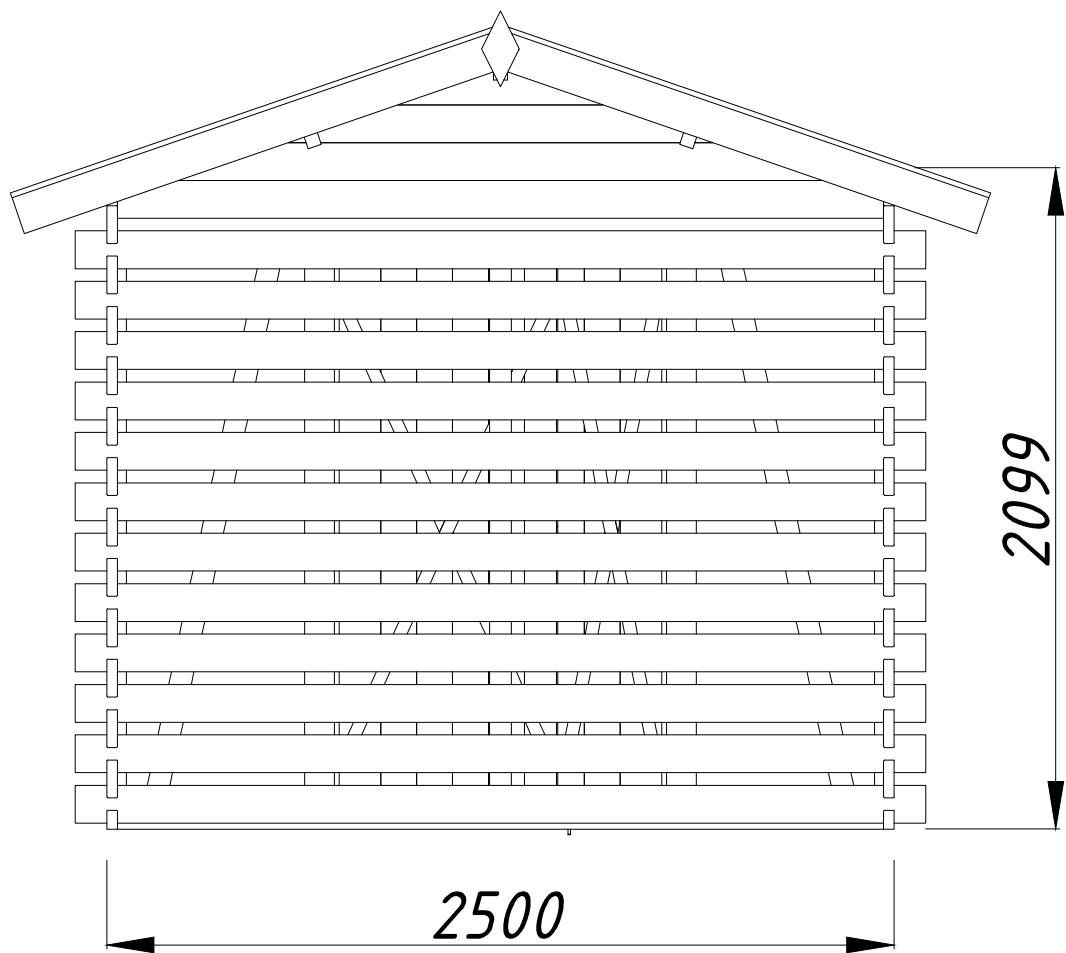
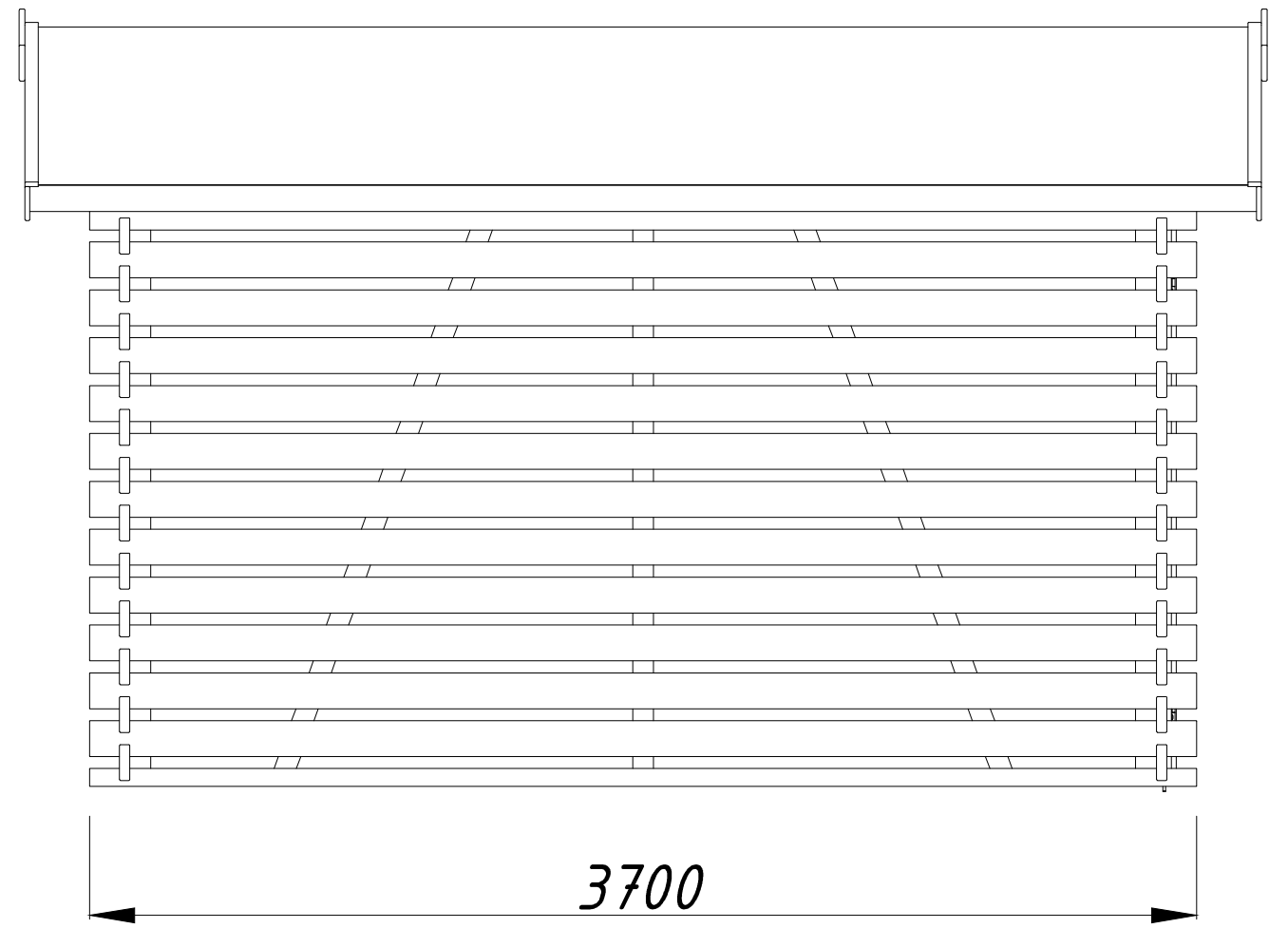
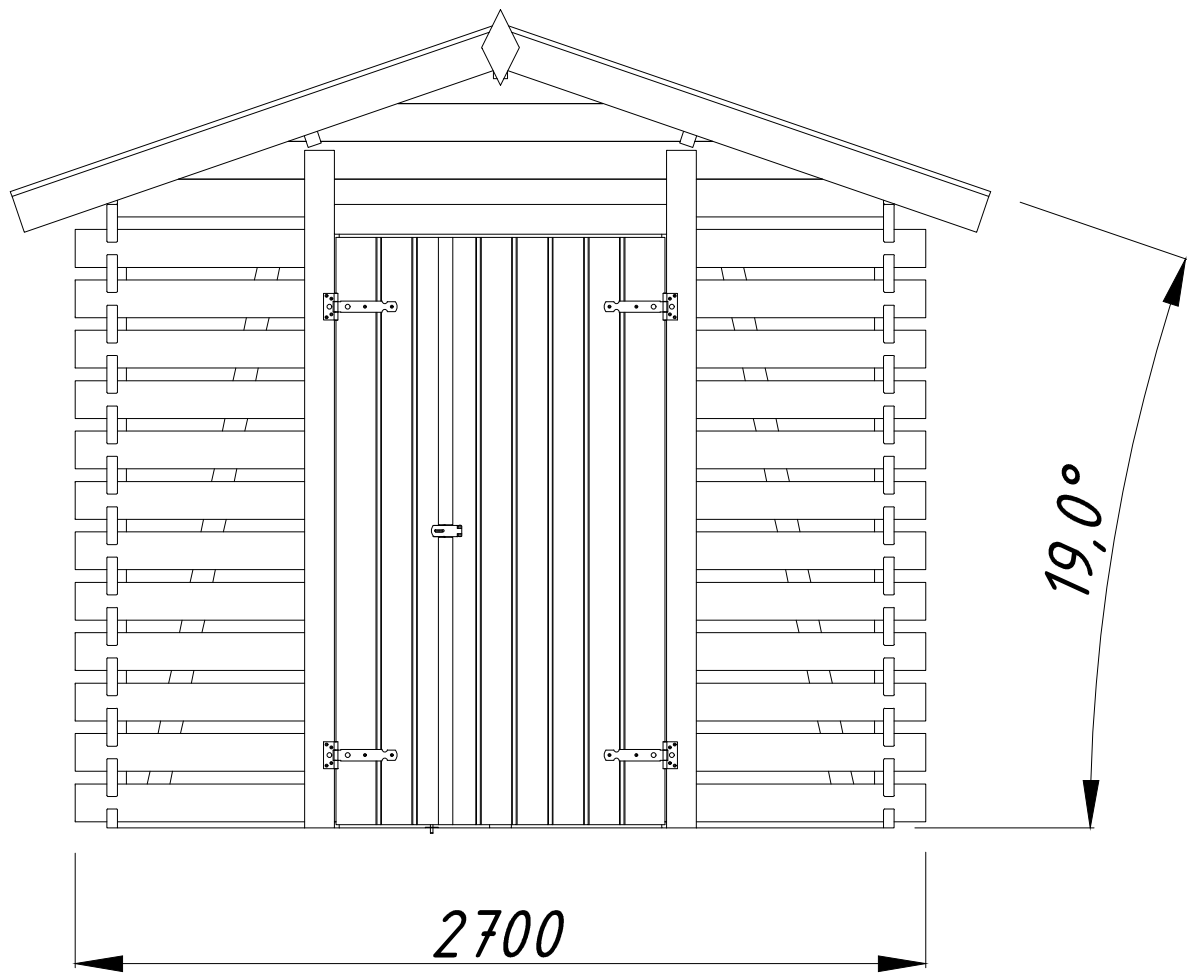

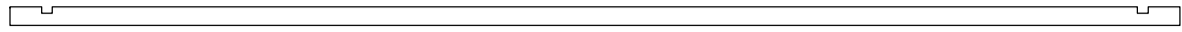

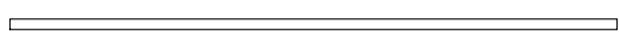
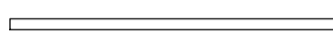

8.4m²

350

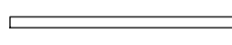
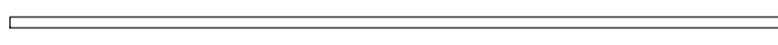





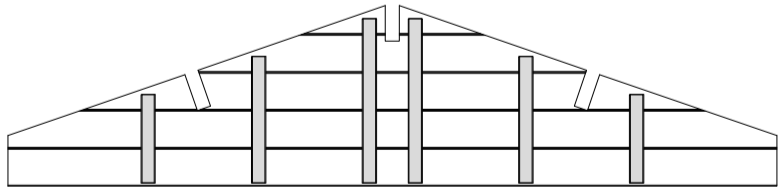
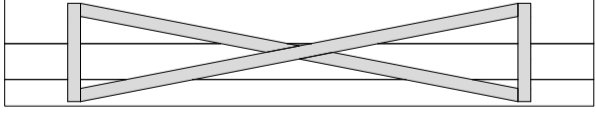
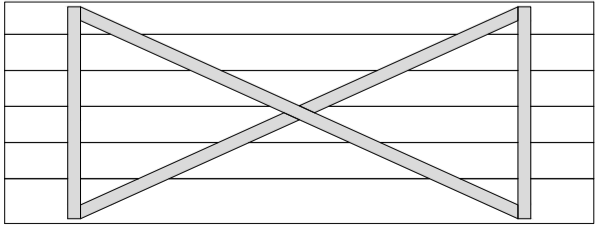

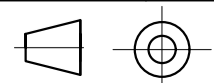

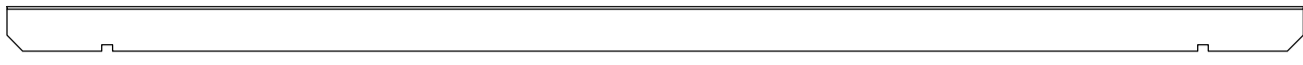
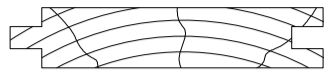
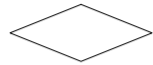

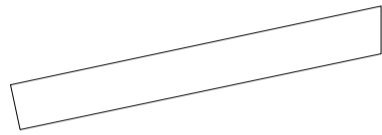
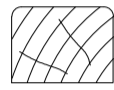
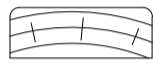
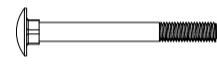
310

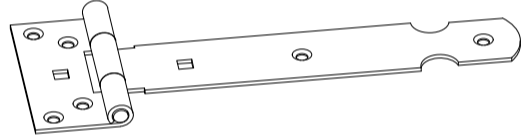
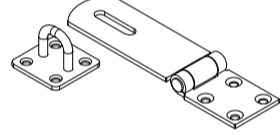
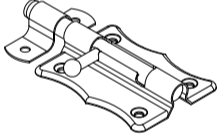

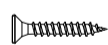
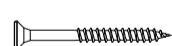

| Pos | SPECIFICATION-STÜCKLISTE-NOMENCLATURE-ELEMENTI-ESPECIFICACIÓN FR34-2737 | Pcs | Profile (mm) | Length (mm) |
|-------|---|-----|-----------------|----------------|
| Det1 | Detail- Detail- Detail- Dettaglio- Detalle  | 2 | 59x34 | 3700 |
| Det2 | Detail- Detail- Detail- Dettaglio- Detalle  | 24 | 120x34 | 775 |
| Det3 | Detail- Detail- Detail- Dettaglio- Detalle  | 12 | 120x34 | 2700 |
| Det4 | Detail- Detail- Detail- Dettaglio- Detalle  | 22 | 120x34 | 3700 |
| Det5 | Detail- Detail- Detail- Dettaglio- Detalle  | 2 | 120x34 | 3700 |
| Det6 | Detail- Detail- Detail- Dettaglio- Detalle  | 2 | 120x34 | 4100 |
| CnB1 | Connecting board- Verbindungsbrett- Madrier de connection- Tavola di collegamento- Listón de juntura  | 2 | 59x34 | 1920 |
| CnB2 | Connecting board- Verbindungsbrett- Madrier de connection- Tavola di collegamento- Listón de juntura  | 1 | 59x34 | 1024 |
| Sis1 | Side slat- Randleiste- Baguette en bordure- Listón de borde- Listello bordo  | 4 | 95x16 | 2150 |
| Sis2 | Side slat- Randleiste- Baguette en bordure- Listón de borde- Listello bordo  | 1 | 95x16 | 1054 |
| Sla1 | Slat- Leiste- Baguette- Listello- Listón  | 2 | 19x34 | 704 |
| Sla2 | Slat- Leiste- Baguette- Listello- Listón  | 1 | 19x34 | 2432 |
| Sla3 | Slat- Leiste- Baguette- Listello- Listón  | 1 | 40x32 | 2432 |
| Sla4 | Slat- Leiste- Baguette- Listello- Listón  | 2 | 40x32 | 641 |
| Sla5 | Slat- Leiste- Baguette- Listello- Listón  | 2 | 45x16 | 912 |
| SP1 | Support brace- Stützleiste- Baguette de support- Listello di supporto- Listón de soporte  | 8 | 70x28 | 2190 |
| SP2 | Support brace- Stützleiste- Baguette de support- Listello di supporto- Listón de soporte  | 1 | 70x28 | 2377 |
| SP3 | Support brace- Stützleiste- Baguette de support- Listello di supporto- Listón de soporte  | 6 | 70x28 | 2090 |
| Wel-1 | Wall element- Wandelement- Panneau du mur- Elemento di muro- Elemento pared  | 2 | 571x53 | 2432 |
| Del-1 | Door element- Türelement- Panneau du porte- Elemento di porta- Elemento puerta  | 1 | 340x48 | 1864 |
| Del-2 | Door element- Türelement- Panneau du porte- Elemento di porta- Elemento puerta  | 1 | 700x48 | 1864 |

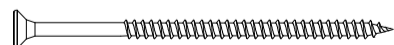

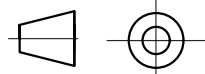
| Pos | SPECIFICATION-STÜCKLISTE-NOMENCLATURE-ELEMENTI-ESPECIFICACIÓN FR34-2737 | | Pcs | Profile (mm) | Length (mm) |
|---|---|---|----------|-----------------|----------------|
| PR1 | Purlin- Dachpfette- Arbalétrier- Arcareccio- Correa  | | 2 | 44x140 | 4100 |
| PR2 | Purlin- Dachpfette- Arbalétrier- Arcareccio- Correa  | | 1 | 44x140 | 4100 |
| RB2-1 | Roof board- Dachbrett- Madrier du toit- Tavola tetto- Tabla de tejado |  | 94 | 89x19 | 1600 |
| Dia-1 | Diamond- Deckbrett- Madrier- Tavola di copertura- Rombo |  | 2 | 19x140 | 300 |
| EaE1-1 | Eave edging- Dachrandbrett- Madrier en bordure du toit- Tavola bordo tetto- Tabla de valadizo |  | 2 | 16x95 | 4100 |
| FaB3-1 | Facia board- Giebelblende- Écran frontal- Schermo frontone- Tabla de facia |  | 4 | 16x120 | 1640 |
| RE2-1 | Roof edge reinforcement- Dachrandleiste- Baguette en bordure du toit- Rinforzo bordo tetto- Refuerzo borde tejado |  | 2 | 32x40 | 4100 |
| WB1-1 | Wind brace- Windbrett- Madrier contre le vent- Tavola vento- Tabla contra el viento |  | 4 | 16x45 | 1640 |
| Fim | -Fixing kit- Befestigungsset- Moyens de fixation- Materiale di fissaggio- Kit de fijación | | 1 | | |
| QPOYP 6x60Zn | Bolt -Schloss-schraube -Boulon- Bullone- Perno- M6x60mm PUPO |  | 4 | | |
| QPOYP 6x80Zn | Bolt -Schloss-schraube -Boulon- Bullone- Perno- M6x80mm PUPO |  | 4 | | |
| QHT2 00Zn | Door hinge- Türbänder- Charniere de porte- Cerniere porta- Bisagra de puerta- QHT200Zn |  | 4 | | |
| QTA35 x100Zn | Hasp- Haspe- Porte-cadenas- Portaluchetto- Amella para candado- 100x35x2.5Zn |  | 1 | | |
| QR70 53ZN | Hook- Haken- Crochet- Ganzio- Pestillo QR7053ZN |  | 2 | | |
| QNA3 x70Zn | Nail- Nagel- Clou- Chiodo- Clavo- 3x70mm |  | 350 | | |
| QMUK K6Zn | Nut- Schraubenmutter- Écrou- Dado- Tuerca- M6mm |  | 8 | | |
| QKRPP3 _5x40Zn | Screw- Schraube- Vis- Vite- Tornillo- 3.5x40mm |  | 100 | | |
| QKRP P4_5 X30Zn | Screw- Schraube- Vis- Vite- Tornillo- 4.5x30mm |  | 32 | | |
| QKRPP4 _5x50Zn | Screw- Schraube- Vis- Vite- Tornillo- 4.5x50mm |  | 500 | | |
| QKRPP4 _5x70Zn | Screw- Schraube- Vis- Vite- Tornillo- 4.5x70mm |  | 100 | | |
| QKRPP 4x16Zn | Screw- Schraube- Vis- Vite- Tornillo- 4x16mm |  | 20 | | |
| QKRPP6 x120Zn | Screw- Schraube- Vis- Vite- Tornillo- 6x120mm |  | 14 | | |
| QKRPP6 x150Zn | Screw- Schraube- Vis- Vite- Tornillo- 6x150mm |  | 2 | | |
| QSE6 x18Zn | Washer- Dichtscheibe- Joint- Rondella- Arandela- 6x18mm |  | 8 | | |
|  Object name FR34-2737 | | | Page 2/2 | | |

H = 1.500 m
TOTAL: 8.35 m²

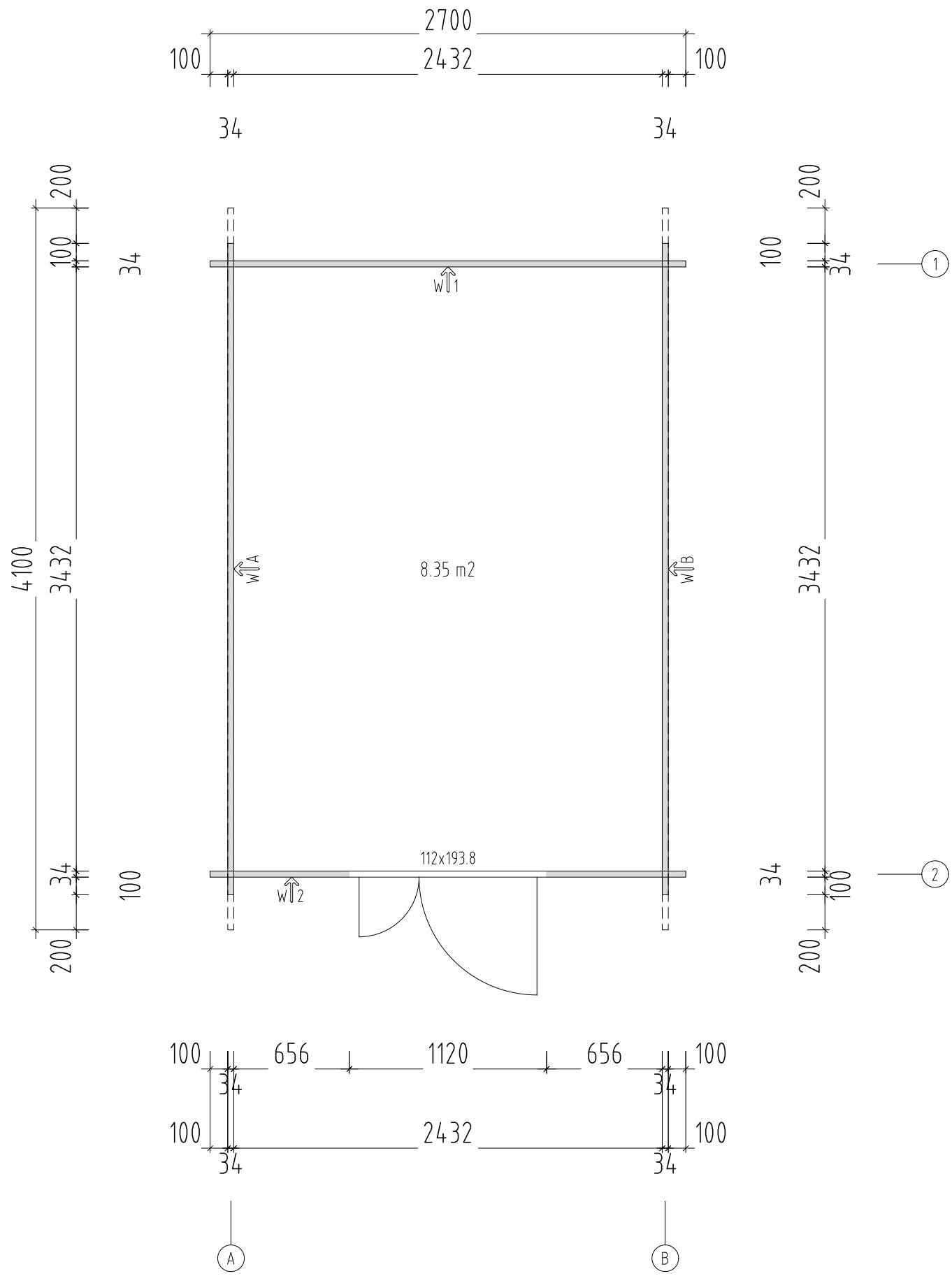

EN: *Laying on concrete slabs (not included)*
FR: *Pose sur dalle béton (non inclus)*

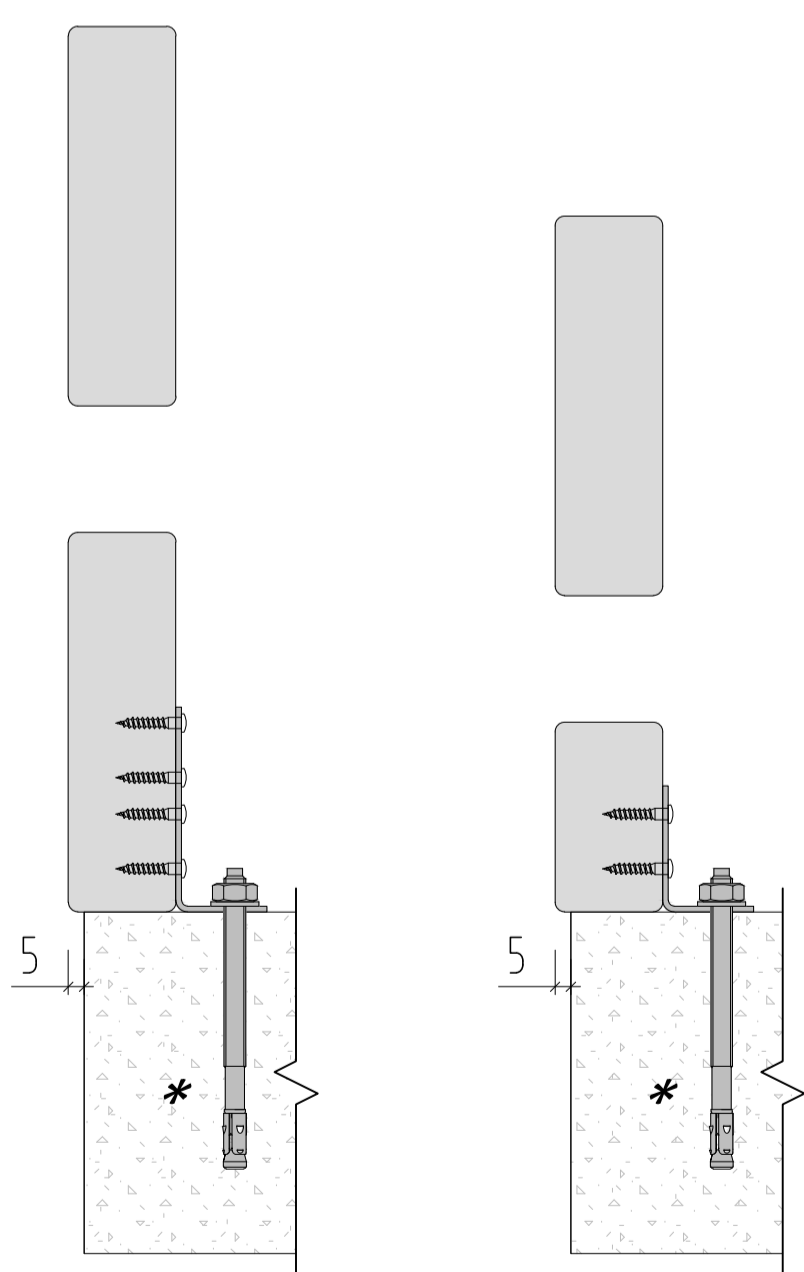
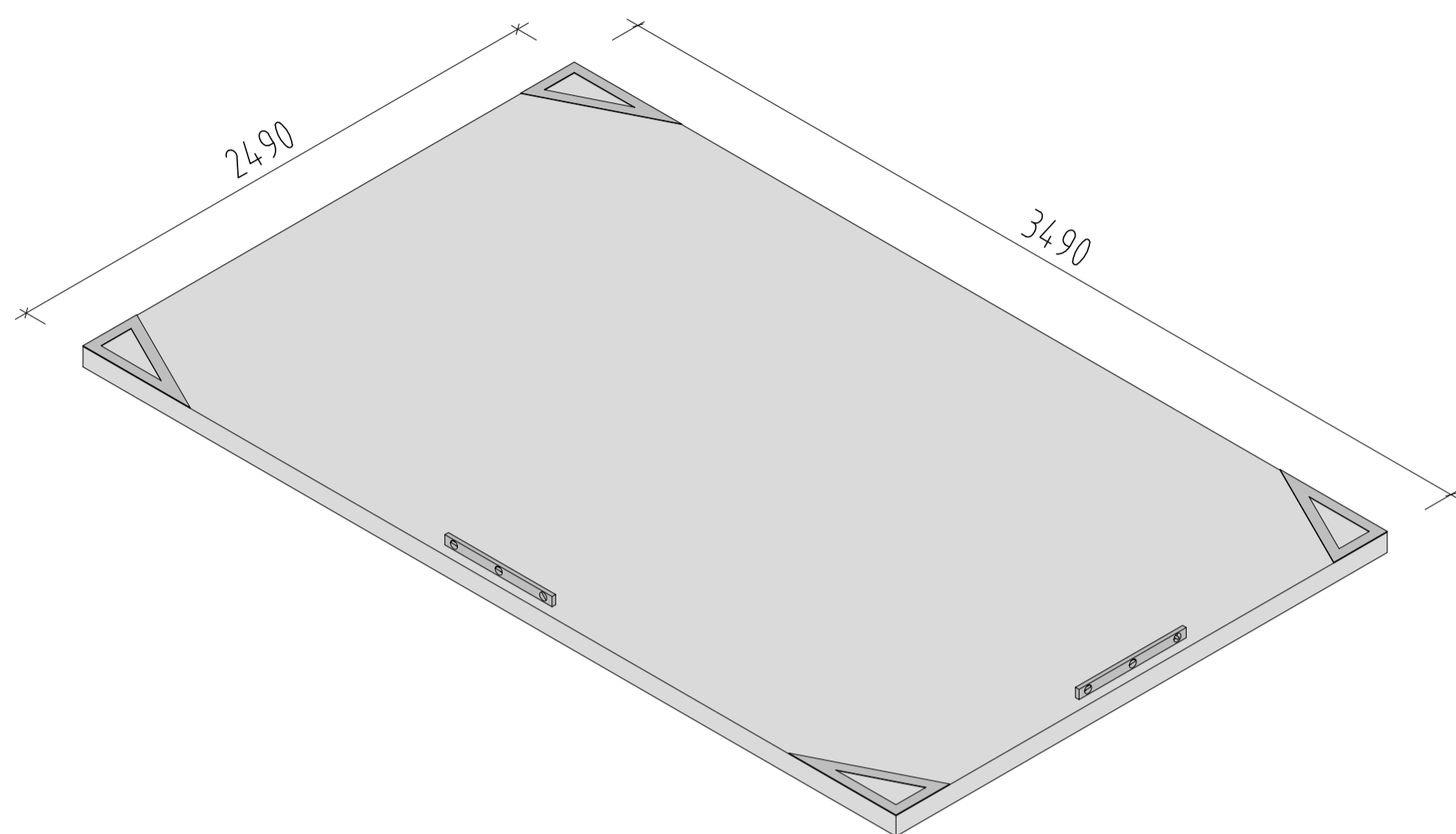
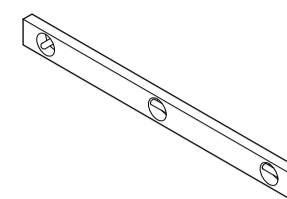

EN: ** Laying on concrete slabs (not included)*
FR: ** Pose sur dalle béton (non inclus)*
EN: *** Laying on wooden floor (not included)*
FR: *** Pose sur plancher (non inclus)*

